



DL.2 Digital Light with Collage™ Software

User Manual

© Barco Lighting Systems, 2010. All Rights Reserved.

Information and specifications in this document are subject to change without notice. High End Systems, Inc. assumes no responsibility or liability for any errors or inaccuracies that may appear in this manual.

Trademarks used in this text: High End Systems and WholeHog are registered trademarks; and the DL.2 logo, Collage, Collage Generator, Hog iPC, the High End Systems globe logo and the Hog logo are trademarks of High End Systems, Inc. or High End Systems Europe Ltd. Belden is a registered trademark of Belden, Inc. Microsoft, DirectX, and Windows are either registered trademarks or trademarks of Microsoft Corporation in the United States and/or other countries. Super HAD and Sony are registered trademarks or trademarks of Sony Corporation in the United States and/or other countries. Art-Net is a registered trademark of Artistic License Corporation. Lightwave 3-D is a registered trademark of Newtek. Mac OS is a trademark of Apple Computer, Inc. registered in the U.S. and in other countries.

Other trademarks and trade names may be used in this document to refer to either the entities claiming the marks and names or their products. High End Systems disclaims any proprietary interest in trademarks and trade names owned by others.

DL.2 User Manual
Software Release Version 2.0
July, 2010

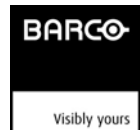

Contacting High End Systems®

Sales Department

High End Systems, Inc.
2105 Gracy Farms Lane
Austin, TX 78758 USA
voice: 512.836.2242
fax: 512.837.5290
Toll Free: 800.890.8989

Customer Service

High End Systems, Inc.
2105 Gracy Farms Lane
Austin, TX 78758 USA
voice: **800.890.8989**
fax: **512.834.9195**
toll free: **800.890.8989**
email: **support@highend.com**

World Wide Web: <http://www.highend.com>

Patents

This High End Systems product is protected by patents and pending patent applications. This product may use one or more of the following patents: US 4,392,187; US 4,602,321; US 4,688,161; US 4,701,833; US 4,709,311; US 4,779,176; US 4,800,474; US 4,962,687; US 4,972,306; US 4,980,806; US 5,010,459; US 5,031,078; US 5,073,847; US 5,078,039; US 5,186,536; US 5,209,560; US 5,278,742; US 5,282,121; US 5,307,295; US 5,329,431; US 5,331,822; US 5,367,444; US 5,402,326; US 5,414,328; US 5,426,576; US 5,430,629; US 5,432,691; US 5,454,477; US 5,455,748; US 5,502,627; US 5,506,762; US 5,515,254; US 5,537,303; US 5,545,951; US 5,588,021; US 5,590,954; US 5,590,955; US 5,640,061; US 5,647,662; US 5,691,886; US 5,702,082; US 5,728,994; US 5,758,955; US 5,758,956; US 5,769,527; US 5,769,531; US 5,774,273; US 5,788,365; US 5,794,881; US 5,795,058; US 5,798,619; US 5,806,951; US 5,812,596; US 5,823,661; US 5,825,548; US 5,828,485; US 5,829,868; US 5,857,768; US 5,882,107; US 5,921,659; US 5,934,794; US 5,940,204; US 5,945,786; US 5,953,151; US 5,953,152; US 5,969,485; US 5,980,066; US 5,983,280; US 5,984,248; US 5,986,201; US 6,011,662; US 6,029,122; US 6,048,080; US 6,048,081; US 6,054,816; US 6,057,958; US 6,062,706; US 6,079,853; US 6,126,288; US 6,142,652; US 6,142,653; US 6,172,822; US 6,175,771; US 6,188,933; US 6,208,087; US 6,219,093; US 6,220,730; US 6,241,366; US 6,249,091; US 6,255,787; US 6,256,136; US 6,261,636; US 6,278,542; US 6,278,545; US 6,278,563; US 6,288,828; US 6,326,741; US 6,327,103; US 6,331,756; US 6,346,783; US 6,421,165; US 6,430,934; US 6,459,217; US 6,466,357; US 6,502,961; US 6,515,435; US 6,523,353; US 6,536,922; US 6,538,797; US 6,545,586; US 6,549,324; US 6,549,326; US 6,563,520; US 6,565,941; US 6,570,348; US 6,575,577; US 6,578,991; US 6,588,944; US 6,592,480; US 6,597,132; US 6,600,270; US 6,601,974; US 6,605,907; US 6,617,792; US 6,621,239; US 6,622,053; US 6,635,999; US 6,648,286; US 6,664,745; US 6,682,031; US 6,693,392; US 6,696,101; US 6,719,433; US 6,736,528; US 6,771,411; US 6,775,991; US 6,783,251; US 6,801,353; US 6,812,653; US 6,823,119; US 6,865,008; US 6,866,390; US 6,866,402; US 6,866,451; US 6,869,193; US 6,891,656; US 6,894,443; US 6,919,916; US 6,930,456; US 6,934,071; US 6,937,338; US 6,955,435; US 6,969,960; US 6,971,764; US 6,982,529; US 6,988,805; US 6,988,807; US 6,988,817; US 7,000,417; US 7,011,429; US 7,018,047; US 7,020,370; US 7,033,028; US 7,048,838; US 7,055,963; US 7,055,964; US 7,057,797; US 7,073,910; US 7,078,869; US 7,092,098; US 7,119,902; US 7,161,562; US 7,175,317; US 7,181,112; US 7,206,023; US 7,210,798; US D347,113; US D350,408; US D359,574; US D360,404; US D365,165; US D366,712; US D370,080; US D372,550; US D374,439; US D377,338; US D381,740; US D409,771; AT E169413; CA 2142619; CA 2145508; CA 2245842; DE 22588.4-08; DE 621495; DE 655144; DE 69320175.4; DE 69322401.0; DE 69331145.2; DE 69525856.7; DE 69734744.3; DE 797503; DK 0655144; DK 1447702; EP 0475082; EP 0621495; EP 0655144; EP 0662275; EP 0767398; EP 0797503; EP 0969247; EP 1447702; ES 0621495; FR 0621495; FR 0655144; FR 0662275; FR 1447702; GB 2043769B; GB 2055842B; GB 2283808B; GB 2290134B; GB 2291814B; GB 2292530B; GB 2292896B; GB 2294909B; GB 2295058B; GB 2303203B; GB 2306887B; GB 2307036B; GB 2316477B; IE 0621495; IT 034244BE; 2005; IT 0621495; IT 0655144; JP 3495373; JP 3793577; NL 0621495; NL 0797503; NL 0969247; UK 0621495; UK 0655144; UK 0662275; UK 0797503; UK 0969247; UK 1447702;

Declaration of Conformity

according to ISO/IEC Guide 22 and EN45104

Manufacturer's name: High End Systems, Inc.

Distributor's name: High End Systems, Inc.

Distributor's address: 2105 Gracy Farms Lane
Austin, Texas 78758 USA

Declares that the product:

Product Name: DL.2

Product Number:All

Product Options:All

conforms to the following EEC directives:

73/23/EEC, as amended by 93/68/EEC

89/336/EEC, as amended by 92/31/EEC and 93/68/EEC

Equipment referred to in this declaration of conformity was first manufactured in compliance with the following standards in 2005:

Safety: EN 60598-1: 1997
EN 60598-2-17; 1990
A1-A3: 1998
A13: 1999

EMC:
EN 55022

Conducted Emissions Class A
Radiated Emissions Class A
ANSI C63.4 Class A
FCC 47 CFR Part 15 Class A
VCCI V-1/2001.04 Class A

EN 55024

EN 61000-4-2 4/8kV
EN 61000-4-3 A1 3V/m
EN 61000-4-4 1kV/0.5kV
EN 61000-4-5 2kV/1kV
EN 61000-4-6 3 Vrms
EN 61000-4-11 >95%-0.5p, 30%-25p,>95%-250p
Class A

EN 61000-3-2
EN 61000-3-3

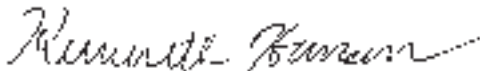

USA, Friday, July 09, 2010
Kenneth Stuart Hansen, Compliance Engineer

Product Modification Warning

High End Systems products are designed and manufactured to meet the requirements of United States and International safety regulations. Modifications to the product could affect safety and render the product non-compliant to relevant safety standards.

Mise En Garde Contre La Modification Du Produit

Les produits High End Systems sont conçus et fabriqués conformément aux exigences des règlements internationaux de sécurité. Toute modification du produit peut entraîner sa non conformité aux normes de sécurité en vigueur.

Produktmodifikationswarnung

Design und Herstellung von High End Systems entsprechen den Anforderungen der U.S. Amerikanischen und internationalen Sicherheitsvorschriften. Abänderungen dieses Produktes können dessen Sicherheit beeinträchtigen und unter Umständen gegen die diesbezüglichen Sicherheitsnormen verstoßen.

Avvertenza Sulla Modifica Del Prodotto

I prodotti di High End Systems sono stati progettati e fabbricati per soddisfare i requisiti delle normative di sicurezza statunitensi ed internazionali. Qualsiasi modifica al prodotto potrebbe pregiudicare la sicurezza e rendere il prodotto non conforme agli standard di sicurezza pertinenti.

Advertencia De Modificación Del Producto

Los productos de High End Systems están diseñados y fabricados para cumplir los requisitos de las reglamentaciones de seguridad de los Estados Unidos e internacionales. Las modificaciones al producto podrían afectar la seguridad y dejar al producto fuera de conformidad con las normas de seguridad relevantes.

FCC Information

This equipment has been tested and found to comply with the limits for a Class A digital device, pursuant to part 15 of the FCC rules. These limits are designed to provide reasonable protection against harmful interference when the equipment is operated in a commercial environment. This equipment generates, uses, and can radiate radio frequency energy and, if not installed and used in accordance with the instruction manual, may cause harmful interference to radio communications. Operation of this equipment in a residential area is likely to cause harmful interference, in which case the user will be required to correct the interference at his own expense.

Important Safety Information

Instructions pertaining to continued protection against fire, electric shock, and injury to persons are found in Appendix E. Please read all instructions prior to assembling, mounting, and operating this equipment.

Important: Informations De Sécurité

Les instructions se rapportant à la protection permanente contre les incendies, l'électrocution, excessif et aux blessures corporelles se trouvent dans l'Annexe E. Veuillez lire toutes les instructions avant d'assembler, de monter ou d'utiliser cet équipement.

Wichtige Sicherheitshinweise

Sicherheitsanleitungen zum Schutz gegen Feuer, elektrischen Schlag, und Verletzung von Personen finden Sie in Anhang E. Vor der Montage, dem Zusammenbau und der Inbetriebnahme dieses Geräts alle Anleitungen sorgfältig durchlesen.

Informazioni Importanti Di Sicurezza

Le istruzioni sulla protezione da incendi, folgorazione, e infortuni sono contenute nell'appendice E. Si prega di leggere tutte le istruzioni prima di assemblare, montare e azionare l'apparecchiatura.

Informacion Importante De Seguridad

En el Apéndice E se encuentran instrucciones sobre protección continua contra incendios, descarga eléctrica, y lesiones personales. Lea, por favor, todas las instrucciones antes del ensamblaje, montaje y operación de este equipo.

Symbols

The following international caution and warning symbols appear in margins throughout this manual to highlight messages.



CAUTION: This symbol appears adjacent to Caution messages. Not heeding these messages could result in personal injury and/or damage to equipment.



WARNING: This symbol appears adjacent to high voltage warning messages. Not heeding these messages could result in serious personal injury.



This symbol indicates the minimum focus distance from a combustible object.



This symbol cautions against mounting the fixture on a flammable surface.



This symbol indicates that, while operating, equipment surfaces may reach very high temperatures. Allow the fixture to cool before handling.

Fog Machine Warning

Like all high quality video projection units, the DL.2 fixture must be kept protected from excessive amounts of glycol fog, mineral oil, and smoke. The DL.2 fixture incorporates two-stage air filtering to reduce these risks to a minimum; however, the user must follow these guidelines to ensure continued operation of the fixture:

- Air filters (both fixture and projector) should be checked and cleaned on a regular basis. When used in a closed or fixed environment where fog or haze is used, we recommend at least a weekly check.
- Do not situate DL.2 fixtures in areas of high fog density such as directly in front of a fog machine or mineral oil hazer.
- Minimize the exposure of DL.2 fixtures to both glycol fog and mineral oil.

The DL.2 fixture is a highly complex and sensitive electro-optical device and care and thought in how it is used, rigged, and positioned will maximize the product's life and your investment.

Failure to follow these guidelines and carry out regular maintenance will void the warranty.

Packaged Media Notice:

Any use of this product other than consumer personal use in any manner that complies with the MPEG-2 Standard for encoding video information for packaged media is expressly prohibited without a license under applicable patents in the MPEG-2 patent portfolio, which license is available from MPEG LA, L.L.C., 250 Steele Street, Suite 300, Denver Colorado 80206.

Warranty Information

Limited Warranty

Unless otherwise stated, your *product (excluding the lamp)* is covered by a one year parts and labor limited warranty. The lamp warranty for Christie projectors is 120 days or 500 hours whatever comes first. It is the owner's responsibility to furnish receipts or invoices for verification of purchase, date, and dealer or distributor. If purchase date cannot be provided, date of manufacture will be used to determine warranty period.

Returning an Item Under Warranty for Repair

It is necessary to obtain a Return Material Authorization (RMA) number from your dealer or point of purchase BEFORE any units are returned for repair. The manufacturer will make the final determination as to whether or not the unit is covered by warranty.

Any Product unit or parts returned to High End Systems must be packaged in a suitable manner to ensure the protection of such Product unit or parts, and such package shall be clearly and prominently marked to indicate that the package contains returned Product units or parts and with an RMA number. Accompany all returned Product units or parts with a written explanation of the alleged problem or malfunction. Ship returned Product units or parts to: 2105 Gracy Farms Lane, Austin, TX 78758 USA.

Note: Freight Damage Claims are invalid for fixtures shipped in non-factory boxes and packing materials.

Freight

All shipping will be paid by the purchaser. Items under warranty shall have return shipping paid by the manufacturer only in the Continental United States. Under no circumstances will freight collect shipments be accepted. Prepaid shipping does not include rush expediting such as air freight. Air freight can be sent customer collect in the continental United States.

REPAIR OR REPLACEMENT AS PROVIDED FOR UNDER THIS WARRANTY IS THE EXCLUSIVE REMEDY OF THE CONSUMER OTHER THAN THE LIMITED WARRANTY STATED ABOVE. HIGH END SYSTEMS, INC. MAKES NO WARRANTIES, EXPRESS OR IMPLIED, WITH RESPECT TO ANY PRODUCT, AND HIGH END SPECIFICALLY DISCLAIMS ANY WARRANTY OF MERCHANTABILITY OR FITNESS FOR A PARTICULAR PURPOSE. HIGH END SHALL NOT BE LIABLE FOR ANY INDIRECT, INCIDENTAL OR CONSEQUENTIAL DAMAGE, INCLUDING LOST PROFITS, SUSTAINED OR INCURRED IN CONNECTION WITH ANY PRODUCT OR CAUSED BY PRODUCT DEFECTS OR THE PARTIAL OR TOTAL FAILURE OF ANY PRODUCT REGARDLESS OF THE FORM OF ACTION, WHETHER IN CONTRACT, TORT (INCLUDING NEGLIGENCE), STRICT LIABILITY OR OTHERWISE, AND WHETHER OR NOT SUCH DAMAGE WAS FORESEEN OR UNFORESEEN.

Warranty is void if the product is misused, damaged, modified in any way, or for unauthorized repairs or parts. This warranty gives you specific legal rights, and you may also have other rights specific to your locality.

What You Should Know About Copyright

The following FAQ can help you understand copyright laws and how they apply to content used with the DL.2 fixture

By *Suzu Vaughan Associates* for High End Systems.

I want to use a film clip from "When Harry Met Sally" in a promotional piece advertising my services. What do I have to do to be able to do that?

First of all, you need to obtain permission to use the clip from its owners. The clip is considered intellectual property, just as though it were your car or some software code developed by and belonging to Microsoft. This is because the U.S. Copyright Act gave creators of literary works (which include books, films, television programs, art works, still photos and musical compositions and recordings) the right to sell or license these works and to make money from them for the period of the copyright.

But what about public domain material? I heard that lots of material is in the public domain and can be used for free.

Once the copyright runs out, the creative work falls into the public domain and can be used freely by anyone without payment or licensing. If the work is not public domain, it is considered literary property. The Copyright Act provides substantial penalties for copyright infringement ranging from \$10,000 for accidental infringement to \$250,000 for willful infringement. However, contrary to popular belief, there really is not that much material in the public domain so this approach will limit you creatively.

What if I want to use a clip in a public performance? It's not being filmed or taped. Surely I don't need permission for that?

Public gatherings require clearance whenever copyrighted data is projected to audiences, or for any use other than just personal viewing. Concerts, trade shows, industrial shows, parties and raves are all examples of public performance and permission must be obtained.

Suppose I want to use a still photo or a magazine cover or a television clip? Do I have to obtain permission for them too?

Yes, they are also copyrighted works, whose owners must grant a license for their usage.

Do I need any other permissions to use this material?

In many cases you do. You may need to obtain permission to use the appearance of actors who appear in the clip as well as pay the writers and directors of the film that your clip comes from.

What about music? I hear you can use 8 bars for free.

8 bars for free is a fallacy that has been passed around as a fact for a long period of time. However, it isn't true. Both musical compositions and records require licensing and payment.

What about High End Systems material included with the DL.2 fixture? Do I have to clear that?

No. High End Systems has worked to provide clearance for the content that is provided with the DL.2 fixture. Any materials you received directly from HES with the purchase of a new DL.2 fixture have already been properly licensed for your use in shows and presentations. That does not, however, license you to sell this content separately from DL.2 fixture. Also, please be sure that any new content you obtain from outside sources is properly cleared for public presentation.

This sounds really difficult and I don't know how to do it? What do I do to properly license copyrighted material?

You need to consult with a Content Clearing House or with a properly licensed Intellectual Property Attorney. Content clearinghouses are typically less expensive to work with and have well established industry relations that can result in cost savings. High End Systems uses and highly recommends Suzy Vaughan Associates. Suzy Vaughan Associates has 20 years of experience in clearing clips, talent, and music for use in any number of venues. Their clients include Barbara Streisand, Michael Jackson, and The Emmys among other shows.

You can obtain more information about Suzy Vaughan Associates' services by calling 818-988-5599 or emailing info@suzyvaughan.com. Their website is www.suzyvaughan.com. Suzy Vaughan is also an attorney specializing in intellectual property issues.

How much does it typically cost to license copyrighted material?

The answer depends entirely on what material you want to use and how you plan to use it. Prices can range from hundreds of dollars for photography content to thousands of dollars for a highly desirable film/video clip. Since price is content-sensitive, the best thing to do is to contact a clearinghouse like Suzy Vaughan Associates and let them find out for you.

Table of Contents

DL.2 Digital Light with Collage™ Software

Contacting High End Systems®	ii
Patents	ii
Declaration of Conformity	iii
Product Modification Warning	iv
FCC Information	iv
Important Safety Information	iv
Symbols	v
Fog Machine Warning	v
Packaged Media Notice:	v
Warranty Information	v
What You Should Know About Copyright	vi

Chapter 1: Product Overview

This chapter describes the features and specifications of the DL.2 fixture and the Content Management Application software.

Features	2
System	2
Graphics Engine	2
Content Management Application	3
Hardware	3
Related Products and Optional Accessories	4

Setup and Configuration

Hardware setup includes mounting, connecting to power and establishing Ethernet and DMX links. Software setup includes launching the Content Management Application (CMA) and configuring the fixture for DMX control.

Hardware Setup	5
Unpacking the Fixture	5
Hardware Components	6
Connection Ports	6
Pan and Tilt Locking	7
Attaching a Power Cord Cap	7
Installing a Line Cord Cap - U.K. Only	7
Vatic Fitter Heads Information - Danmark	7

Mounting the Fixture	8
Fog Machine Warning	8
Mounting the Fixture Upright	9
Truss Mounting	9
Linking DL.2 Fixtures	10
Setting up an Ethernet Fixture Link	11
Linking Configurations	11
Powering On the Fixture	12
Homing the Fixture	13
The DL.2 Menu Display Panel	13
Software Setup	14
Installing and Launching the Content Management Application (CMA)	14
Verifying and Upgrading Fixture and CMA Software	15
Configuring DL.2 Fixtures	16
Setup Configuration Using the Menu System	16
Setup Configuration Using the CMA	17
DL.2 Channel Range and Valid Start Channels	18
DMX Control Setup	19
Patching the DL.2 Fixture to a Wholehog Console	19
Viewing Output	19
Shutting Down the Fixture	19
Recommended Shutdown Options	19
Placing Fixture in Road Case	20

Chapter 3: The Digital Light Menu System

DL.3 and DL.2 digital lights have an onboard Menu System you can use to configure the fixture, review diagnostic feedback, and view content information.

Menu Panel Components	21
LCD Display Adjustment Buttons	22
LCD Display Power Button	22
LCD Display Menu Options and Selection	22
Navigating the Menu	23
Menu Options	24
Menu Screen Descriptions	28
DMX Tab	28
DMX_Control Screen	28
DMX_Protocol Tab	29
DMX_Protocol_Motion Screen	29
DMX_Protocol_Global Screen	29
DMX_Protocol_Obj Screens	29

DMX_Raw Screen	30
Set Tab	31
Set_Fixture Screen	31
Set_Projector Screen	32
Set_I/O Screen	33
File Tab	34
Info Tab	35
Info_Hours	35
Info_Version Screen	35
Info_Status Tab	36
Info_Hardware Tab	36
Test Tab	37
Test_Home Screen	37
Test_Self Test Screen	37
Reset Screen	38

Chapter 4: DMX Programming Basics and Quick Start

If you are new to DMX programming, this chapter gives you a brief overview on programming DL.3, DL.2, and Axon media servers and an example of using a Wholehog console to patch and display output from a media server.

DMX Programming Overview	39
DMX512 Links	39
8-bit vs. 16-bit DMX Parameters	39
Determining a DMX Start Channel	40
Overview	40
Digital Lighting Products	40
Lighting Console Tips	41
Fixture Libraries	41
Patching Digital Light Fixtures and Axon Media Servers	41
DMX Output Displays	42
Wholehog Programming Notes	42
Play Speed	42
Mask Strobe	42
Play Modes (Opacity)	42
CMY	42
Control Channel Functions	42
Quick Start with a Wholehog Console	43

Chapter 5: Tutorials

Five simple lessons get you started programming DL.3, DL.2, and Axon media servers with a Wholehog or other DMX console.

Fixture Set-up (DL.3 and DL.2 Fixtures)	45
Lesson 1: Cross Fading Between Graphic Objects	46
Define Graphic Object 1	46
Add the DL.3 logo as Graphic Object 2	46
Define Graphic Object 3	46
Create Crossfade Cues	46
Lesson 2 - Working with Multiple Graphic Objects	47
Apply Transparency Effects	47
Lesson 3 - Girt, the Fire Breathing Lizard	48
Define Graphic Object 1	48
Define Graphic Object 2	48
Define Graphic Object 3	48
Lesson 4: 3-D Objects, Rotation, Wobulation, and Glow.	50
Define Graphic Object 1	50
Define Graphic Object 2	50
Adjust this effect with the Modifier parameters.	51
Lesson 5: Viewpoint	52
Define Graphic Object 1	52
Define Graphic Object 2	52
Define Graphic Object 3	52
Apply a Global Solarize Effect	53
Adjust Global Viewpoint Mode	53

Chapter 6: Graphics Engine Overview

DL.3, DL.2, and Axon Media servers all use the same graphic engine software to control content selection, playback, and 3-D Object and Global manipulation.

Protocol Options	55
Image Optimizing Controls	56
Graphics Control Hierarchy	56
Graphics Engine Function Flow	57
Graphics Engine Functions	58
Object Graphic Functions	58
Global Functions	58
Making Graphics Effect Choices	58

Chapter 7: Graphic Functions: Defining Content

Each Graphic Object's content is composed of a 3-D object overlaid with a media file. This chapter outlines how to select an image's object and media file components as well as define the video segment and its playback.

Content Overview	59
Selecting Content	59
Content Selection Parameters	60
Object	60
Media Folder	61
Media Folder Descriptions.	62
Media File	63
Defining a Media File Segment	63
In Frame and Out Frame Parameters	63
Segment Selection Examples	64
Defining Playback	65
Playback Mode	65
Scrubbing	65
Playback Speed	66

Chapter 8: Graphic Functions: Rotation, Position, Scale

You can independently control each Graphic Object's rotation direction and speed; along with its position and scale in X, Y, and Z axis directions.

Rotating a 3-D Object	67
Rotation Parameters	69
X Rotation	69
Y Rotation	70
Z Rotation	71
Scaling the Object	72
X Scale	72
Y Scale	73
Z Scale	74
Changing Object Position	75
X Position	75
Y Position	76
Z Position	77

Chapter 9: Graphic Functions: Opacity and Effects

You can adjust opacity and apply a variety of color mixing and geometric effects to each individual Graphic Object.

Opacity	79
Visual Mode	80

Visual Mode Options	82
Color to B/W	82
Content Optimization	82
Chroma Shift	83
CTO/CTB	83
Drop Shadow	84
Exposure Control	85
Faux LED	86
Faux Tile	87
Film Roll	88
Fire Gradient	88
Flip	89
Fuzzifier	90
Gray maker 1	91
Gray maker 2	92
Invert Black and White, Keep Color	92
Negative Art	94
Pan and Scan	95
Pixelate	96
Posterizer	97
Push to Red	98
Push to Sepia	99
ShakeNBake	100
Texture Mixing	100
Zoom Blur	101
Effect Mode Parameters	102

Chapter 10: Graphic Functions: Synchronizing Content

After designating a master fixture, you can synchronize the content of other Axon, DL.3, or DL.2 fixtures to any Graphic Object on the master in terms of playback time, rotation or both.

Network Synchronization Overview	107
Network Synchronization Requirements	107
Network Synchronization Capabilities	108
Programming Synchronization	108
Sync To Parameter	108
Sync Type Parameter	108
Effect Synchronization	109
Synchronizing a Server to Itself	109
Synchronizing a Master Server to another Server	109

Chapter 11: Global Functions

Global Graphic controls affect the composite image created by defining multiple separate object graphics. You can adjust intensity, define masks, select a point in space to view the composite image, and control keystone correction.

Global Intensity	111
Global Effect Mode Channels	112
Global Control	118
Shutdown and Reset Options	118
On-Screen Statistics	118
Spherical Control Statistics	118
Performance Statistics	118
Text Color	118
All-in-One Control Option	119
Masking Control	121
Mask Shape Select and Strobing	121
Mask Shapes	121
Strobing Mask Shapes	121
Mask Size	122
Mask Edge Fade	123
Image Edge Fade	124
Keystone Correction Parameters	125
Keystone X Ratio	126
Keystone Y Ratio	126
Framing Parameters	127
Global Viewpoint Mode	128
..... Perspective View, Spherical Coordinates	128
Perspective View, Cartesian Coordinates	128
Orthogonal View, Cartesian Coordinates	128
Variable Edge Blending	128
Viewpoint Position X	129
Viewpoint Position Y	129
Viewpoint Position Z (Zoom)	129

Chapter 12: Global Functions: Collage Generator™ Effect

Using the Collage Generator™ effect option lets you configure multiple media server outputs to display a single image in arrays up to 16 units horizontal by 8 units vertical.

Collage Generator Options	132
Automated Collage Options	132
User Segmented Collage Options	133
Adjusting the Collage Array with Global Modifier Parameters	134

Collage Setup Example	136
Variable Edge Blending	137
Setting up Variable Edge Blending:	138
Mapping a Collage to a Spherical Surface	138
Spherical Mapping Setup Guide	138
Before You Begin	138
Mapping Two Outputs to a Sphere	139
Spherical Mapping Tips	141
Creating Custom Content for the Collage Generator Effect	141
Collages Using Live S-Video and SDI Input	141

Chapter 13: Effect Mode Options Descriptions

Effects can be applied to the Media File content (texture) mapped onto a 3-D object. Multiple Color and Geometric effects are available in Effect Mode parameters for both individual Graphic object and Global control.

Effect Mode Color Options	144
All or Nothing	144
Background Color	145
Background Color Cycle	145
CMY	146
CMY Add All Pixels	147
CMY Add Non-black Pixels	148
Color Cycle	149
Color DeConverge	149
Colorize Gray Scale	150
Color to Alpha	151
Color to Alpha, Inverted	152
DotP and Resample	153
Edge Detect Black and White	154
Edge Detect Black and White 2	155
Edge Detect Color	156
Edge Fade Color	157
Glow	158
Glow Color Cycle	158
HS Effect Mode Options	159
HS to Gray	159
HS Selected to Transparent	160
HS to Transparent	160
Intensity Key	161
Mask Color	162
Mask Color and Edge Fade Color	163

RGB Add, All Pixels	164
RGB Add2, All Pixels	164
RGB Add to Non-black Pixels	165
RGB Invert	166
RGB Invert and Swap to BRG	167
RGB Invert and Swap to GBR	168
RGB Scale	169
RGB Swap to BGR	169
RGB Swap to BRG	170
RGB Swap to GBR	171
RGB Swap to GRB	172
RGB Swap to RBG	173
Scan Line	174
Sharpen	175
Solarize	176
Solarize 1	176
Solarize 2	177
Solarize 3	177
Solarize 4	177
Solid Color RGB	178
Transparent Color	179
Transparent Color Coarse	179
Transparent Color Fine	179
Transparent Color Medium	179
Transparent Color, Invert	180
Transparent Color Invert, Coarse	180
Transparent Color Invert, Medium	180
Transparent Color Invert, Fine	180
UV Effect Mode Options	181
UV to Gray	181
UV Selected to Transparent	182
UV to Transparent	182
Yxy Luminance Scaling	183
Geometric Effect Options	184
Cartoon Edge	184
Chroma Shift	185

Collage Generator	186
Collage Generator	186
Enhanced Collage Generator	186
Collage Gen 3	186
Collage Generator Wrap	186
Collage Gen 3 Wrap	187
Segmented Collage Generator	187
Segmented Collage Gen 3	187
Segmented Collage Generator Wrap	187
Segmented Collage Gen 3 Wrap	187
Curved Surface Support	188
Digital MSpeed	190
Downward Vertical Streaks	191
Drop Shadow	192
Faux LED	193
Faux Tile	194
Film Burn/Unburn	195
Film Noise	196
Film Roll	197
Flip	198
Edge Frame Profiles	199
Framing Shutter Emulation	199
Fuzzifier	201
Gaussian Blur	202
Gaussian Halo	203
Horizontal Mirror	204
Image Scale and Rotate	205
Lens Grid	206
Magnifying Lens	207
Magnifying Lens 2	208
Mattes	209
Pan and Scan	211
Particle System	212
Particle System 1	212
Particle System 2	214
Particle System 3	214
Picture in Picture	215
Prerotated Translation	216
Pixelate	217
Pixel Twist	218
Prism	219
Raindrop	220

Scene Change	221
ShakeNBake	222
Sinewave, Circular	223
Sinewave, Circular w/X Axis Wobulation	223
Sinewave, Circular w/Y Axis Wobulation	223
Sinewave, Circular w/Z Axis Wobulation	223
Sinewave, Horizontal	224
Sinewave, Horizontal w/X Axis Wobulation	224
Sinewave, Horizontal w/Y Axis Wobulation	224
Sinewave, Horizontal w/Z axis Wobulation	224
Sinewave, Vertical	225
Sinewave, Vertical w/X Axis Wobulation	225
Sinewave, Vertical w/Y Axis Wobulation	225
Sinewave, Vertical w/Z Axis Wobulation	225
Slats	226
Vertical Slats	226
Horizontal Slats	226
Spherical Mapping	227
Spherical Mapping, Outside	227
Spherical Mapping, Inside	227
Modifier Parameter Adjustments	227
Texture Mixing	229
Texture Ripple, Asymmetrical Circular	230
Texture Ripple, Circular	230
Texture Ripple, Horizontal	231
Texture Ripple, Vertical	231
Texture Shift	232
Tiling On	233
Transparent Wipes.....	234
Zoom Blur	235

Chapter 14: Fixture Motion Functions

This chapter describes mechanical movement control for DL.3 and DL.2 fixtures.

Pan and Tilt	237
Dimmer	237
Focus	237
Zoom	237
MSpeed (Motor Speed)	238

Control Function Options	238
Fixture Operations	238
Projector Control	239
Control Parameter Projector Options	239
Using the Internal Projector's Menu	240

Chapter 15: Live Video Input and Control

The graphics engine in a DL.2 fixture can receive video from an external source or its own integrated digital video camera equipped with an infrared illuminator to provide a direct digital video feed option.

Live Video Sources	241
Internal Camera	241
Other Video Sources	241
Live Video Connection Options	242
Configuring the Video Input Source	242
Sending the Camera Feed to Camera Out	243
Controlling the Internal Camera Input	243
Camera Zoom	243
Camera Focus	243
IR Illuminator	243
Camera Shutter	243
White Balance Mode	244
Orientation	244
Camera Effects	244

Chapter 16: Content Management Application (CMA)

A Content Management Application (CMA) running on an Axon media server or a computer connected through an Ethernet network gives you remote control of content, software and configuration management functions.

Launching the CMA	246
Installing the CMA on Your Computer	246
Launching the CMA on Axon	246
Auto Discovery	247
Fixture Identification	247
The CMA Client Window	248
Viewing Server Identification Information	249
Content Organization	250
Preloaded Stock Content	250
Custom User Content	251
Media Files	251
Object Files	252

Viewing Server Configuration Data	253
Viewing Content	253
Viewing Folders	253
Viewing Files	254
Managing User Content	256
Naming and Deleting User Content Files and Folders	256
Assigning DMX Values to User Content	256
Assigning DMX Values Automatically	256
Editing User Content DMX Values	257
Valid DMX Values	257
Moving User Content Files and Folders	258
Downloading Content from a Media Server to Your Local Drive	259
Uploading Content from Your Local Drive to a Media Server	260
Content Scanning	260
CMA Interaction	261
Content Loaded Prior to Version 1.5	263
Warnings	263
Errors	263
Archiving User Content	265
Using Local Archives to Prepare Content Offline	265
Creating a Local Archive	265
For CMA Running Windows OS	265
For CMA Running Mac OS	266
Creating Content Backup Archive	266
Deploying a Content Archive	266
Cloning User Content	267
Deleting Content	268
DMX Summary	268
Upgrading Software	270
Verifying Software Versions	270
Upgrading the CMA Software	270
Upgrading Server Software	270
Viewing Server Configuration	272
Viewing Current Configuration of All Servers	272
Configuring Columns	273
Re-Order Columns	273
Viewing Individual Fixture Configuration Values	273

DL.3 and DL.2 Media Server Configuration Options	276
Server Tab	276
DMX Settings	276
Server Info	277
Version Info	277
Miscellaneous	277
Fixture Tab	278
Projector Settings	278
Fixture Settings	278
Display Settings	279
Projector Diagnostics	279
Lamp Tab	280
Test/Reset Tab	281
Home/Reset	281
Self Tests	281
Hardware Tab	282
Server	282
Performance	282
Capture	283
Projector	283
I/O Tab	284
Signal Format	284
Signal Routing	284
Axon Media Server Configuration Options	285
Server Tab	285
DMX Settings	285
Server Info	285
Version Info	286
Miscellaneous	286
Display Settings Tab	287
Graphics Output Display Settings	287
Projector Settings	287
Self Tests	287
Hardware Tab	288
Server	288
Performance	288
Capture	288
I/O Tab	289
Signal Format	289
Configuration Example	290

Chapter 17: Maintenance and Troubleshooting

This chapter includes information on replacing parts, cleaning the fixture, and some basic troubleshooting procedures.

Pan and Tilt Locking	293
Maintaining the Filtering System	294
Filter Warnings	294
Cleaning and Replacing Filters	294
Cleaning the Base Housing Filter	295
Replacing the Fixture Filter	295
Cleaning the Internal Projector Filter	296
Replacing the Lamp	297
Replacing the Fuse	298
Cleaning or Replacing the Front Window	298
Replacing Motor Driver Boards	299
Fixture Head Driver Board	300
Replacing Fixture Base Driver Board	300
Troubleshooting	301
Button Shortcut Commands	301
Status Message Menu Display	301
Button Action	302
Inactivity Timer	302
Supported Error/Warning Messages	302
System State LEDs	303
Board LED States	304
General Troubleshooting Suggestions	304
Frequently Asked Questions	306

Chapter 18: Restoring the System

You can perform a system restore on a DL.3, Axon, or DL.2 Server with your System Restore CD.

Hardware Requirements	307
Performing the System Restore	307

Appendix A: DMX Protocol

DL.3 and DL.2 Digital Lights, and Axon Media Servers utilize the same DMX protocol with the following variations:

DL.3 and DL.2 fixtures include channels for motion and camera control

DL.2 and original Axon media servers allow a maximum of four Graphic Objects instead of nine

DL.3 and DL.2 Version 2 DMX Channel Assignment	311
DL.3 and DL.2 Mechanical Control	311
DL.3 and DL.2 Global Control	312
DL.3 and DL.2 Graphic Object Control	313
Axon Media Server Version 2 DMX Channel Assignment	314
Axon Global Control	314
Axon Graphic Object Control	315
Parameter Description and Options	316

Appendix B: MSpeed Conversion Table 345

This table lists the MSpeed (motor) movement times and their corresponding DMX controller values.

Appendix C: Custom User Content 347

There are several considerations to keep in mind when creating custom content to control with the DL.2, DL.3 or Axon graphics engine software.

Preparing Custom Content	347
Encoder Selection	347
Creating 3-D Objects	348
Managing Custom Content	348

Appendix D: DL.2 Specifications

Fixture mechanical, electrical, optical and component specifications are listed.

Mechanical	349
Electrical Specifications	350
Projector Specifications	350
Camera Module Specification	350
Environmental Specifications	350
Cable and Connector Specifications	351
Video Connectors:	351
Peripheral/Network Connectors:	351
DMX and RS-485 Projector Link	351

Appendix E: Safety Information	353
Appendice E: Importantes Informations Sur La Sécurité	354
Anhang E: Wichtige Hinweise Für Ihre Sicherheit	355
Apéndice E: Información Importante De Seguridad	356
Appendice E: Importanti Informazioni Di Sicurezza	357
Vigtig Sikkerhedsinformation	357

Chapter I:

Product Overview

This chapter describes the features and specifications of the DL.2 fixture and the Content Management Application software.

The DL.2 (Digital Light 2) fixture merges video projection and automated lighting technologies with a DMX controllable digital media server housed in a moving yoke fixture. The built-in 32-bit **Graphics Engine** utilizes Windows XP Embedded and DirectX application programming interface to provide extensive image control of up to three 3-D graphic objects.

DL.2 fixtures use DMX512 protocol to control hardware functions like pan, tilt, and zoom, as well as media control functions including loading images and movies and mapping them onto 3-D graphical objects. The internal graphics engine lets you manipulate position, scale, rotation, apply visual effects and color mix each graphic object. You can create and control up to four of these objects and then apply global effects to the composite image.

The DL.2 fixture provides a fully equipped internal digital camera and IR illuminator to input live video to its own graphic engine or to another DL.2 fixture or device. While combining camera and light from the same source to allow a unique point of view, the camera also features optical and digital zoom, frame rate and invert effects as well as freeze frame, color negative and grayscale conversion effects. The ability to point the camera at it's own projection combined with adjustable zoom creates unique realtime video feedback and "hall of mirrors" effects. The IR illuminator allows visibility, focusing, and fading in blackout situations.

The **Content Management Application** (CMA) runs on your workstation or laptop computer and communicates with DL.2 fixtures over an Ethernet network. The CMA lets you remotely upload, move and clone content files, configure fixtures, and upgrade software. It also provides tools for resource monitoring and the capability for downloading log files to assist customer service in diagnosing any software issues that may arise.

Features

System

- DL.2 software based on Windows XP Embedded and DirectX technology
- Powerful Content Management and Configuration software can remotely manage multiple DL.2 fixtures
- Integrated Sony camera with Super HAD technology and infrared illuminator provides live video input and output from fixture location
- Supports importing of custom content including: 3D objects, media files, still images
- DMX512 and Art-Net support
- Remote software upgrade capability
- Royalty-free stock digital art collection features over 1000 lighting-optimized files
- RGBHV and S-Video connections accept a wide range of media device inputs
- Collage™ software included with graphics engine

Graphics Engine

- Simultaneous playback of three discrete media streams on separate 2D/3D objects
- Image Optimizing Controls let you adjust both Black Level and Contrast for each cue and for each image
- 34 Object parameters give you graphic controls for each individual media stream including:
 - A choice of multiple play modes and play speeds
 - The ability to define any segment of a video loop including Scrub capability
 - Three Graphic Effect Mode channels provide multiple color mixing and visual effects
 - Variable Opacity to allow for crossfading or dissolves between media streams
 - Full control of image Rotation, Positioning and Scaling on X, Y and Z axes
 - Visual Modes that let you control black level and contrast to optimize content
 - Video input or camera capture you can apply to 2D/3D objects
- 52 Global parameters control a composite image created by up to four media streams
 - Collage Generator™ technology configures multiple media server outputs to display a single image in arrays up to 16 horizontal x 8 vertical.
 - Curved Surface Support corrects for shape distortions that occur when you project onto surfaces that aren't flat.
 - Intensity overlays the opacity control to provide system-wide intensity level
 - Overall image Color Mixing applied to composite media stream image
 - Five Global Effect Mode channels provide multiple effects that can be applied to the composite image
 - Multiple Mask selections with edge fading and strobe effects
 - Edge fading for creating montages
 - Keystone correction of output projection
 - Digital Framing Shutters
 - Viewpoint controls provide ability to change viewing angle/perspective on images

- Multiple modes for synchronizing content playback on multiple media servers linked through an Ethernet network.

Content Management Application

- Available for Windows and Mac operating systems
- Communicates with other DL.3, DL.3F, DL.2, Axon media servers over an Ethernet network
- Uploads and downloads custom digital content to fixtures on a DMX link
- Configures DL.3, DL.3F, DL.2 and Axon media servers
- Updates software including content, applications, and operating system to DL.3, DL.3F, DL.2 and Axon media servers.
- Three “gas gauges” in the server’s Hardware Tab let you view available CPU, GPU and HDD resources remaining. This gives you the information you need to manage additional layers within the capabilities of the hardware available in their system.
- Log File Download available in All Servers view in the CMA to provide troubleshooting information to customer service if a problem occurs. Logs are saved with a .dlf (digital log file) extension.

Hardware

- 17 Motion Parameters for mechanical fixture control include:
 - Mechanical Iris adjustment to full black-out
 - 400-degree Pan and 240-degree Tilt movement
 - DMX control of projector zoom and focus
 - DMX control of camera functions
- Integrated digital camera feeds digital video capture directly into the graphic engine that provides:
 - Optical + digital zoom to increase image up to 216×
 - Options for 1-30 frame captures / sec
 - Vertical and/or Horizontal image inversion
 - Black and White, Color Negative and Freeze Frame effects
 - White Balance including Red and Blue gain control
- Infrared illuminator allows video capture even in blackout settings
- Remote video input and output switching let you select live video from external source including another DL.2 fixture’s camera feed.
- Full color display and menu functions
- Gigabit Ethernet for fast content uploading and multiple fixture synchronization
- Mounting system provides multiple orientation options

Related Products and Optional Accessories

The following table lists related products and accessories available for the DL.2 fixture. For more information, contact your High End Systems dealer/distributor (see *Contacting High End Systems®* on page ii.)

Part Description	Part Number
Replacement lamp: LX50 projector model	55030070
Replacement lamp: LX55 projector model	55030082
Replacement Filter, fixture head	80260014
Replacement Filter, Projector Lamp Small	80260018
Replacement Filter, Projector Lamp Large	80260017
5-amp, slow-blow fuse	90403012
Front window	80530074
Wholehog 3 lighting console	61020001
Hog iPC lighting console	74020001
Galvanized safety cable	12040001
Mega-Claw clamp	67040007
Male 5-pin DMX terminator	90404039
Heavy duty 5-pin XLR cable (10')	55050017
Heavy duty 5-pin XLR cable (25')	55050018
Heavy duty 5-pin XLR cable (50')	55050019
Heavy duty 5-pin XLR cable (100')	55050020

Chapter 2:

Setup and Configuration

Hardware setup includes mounting, connecting to power and establishing Ethernet and DMX links. Software setup includes launching the Content Management Application (CMA) and configuring the fixture for DMX control.

Hardware Setup

The following steps make up the hardware setup for DL.2 fixtures:

1. **Unpack DL.2 Media Server.**
2. **Install power cord cap if necessary for your location.**
3. **Mount the fixture upright or suspended from a standard truss.**
4. **Connect to an Ethernet network linked to a computer or an Axon media server running CMA software, and any other DL.2, DL.3, or Axon units you wish to control via the CMA.**
5. **Connect the fixture to a DMX controller via DMX cabling or an Art-Net box on the Ethernet network.**
6. **Connect the fixture to power.**

Unpacking the Fixture

Your DL.2 fixture ships in a road case specifically designed to protect the product during transport. When unpacking, inspect both the outside of the fixture and the projector for physical damage to components.

The following are included in your shipment:

- One DL.2 fixture in road case
- Two mounting brackets
- One safety cable
- Documentation CD that contains
 - CMA application
 - User Manual in .pdf format
 - Fixture software
 - Recovery software image

High End Systems® assumes no responsibility for products that are damaged during transport. Return a product for repair in its road case.

Before sending anything to the factory, call your High End Systems dealer/distributor for a Return Material Authorization (RMA) number. The factory cannot accept any goods shipped without an RMA number.

Hardware Components

Connection Ports

The DL.2 fixture's back panel provides ports for:

- **5-pin DMX Data In and Data Out** (see *Setting up a Standard DMX Link* on page 10 for more information).
- **Ethernet** to connect to other DL.2 fixtures and your computer running the Content Management Application (CMA) software on a fixture link (see *Setting up an Ethernet Fixture Link* on page 11).
- Two **USB** ports for connecting peripheral drives to assist with troubleshooting
- **RGBHV, VGA** and **S-Video** In options for video input.
- **Camera Out** provides S-Video output from the internal camera to another DL.2 fixture or other external video output device.

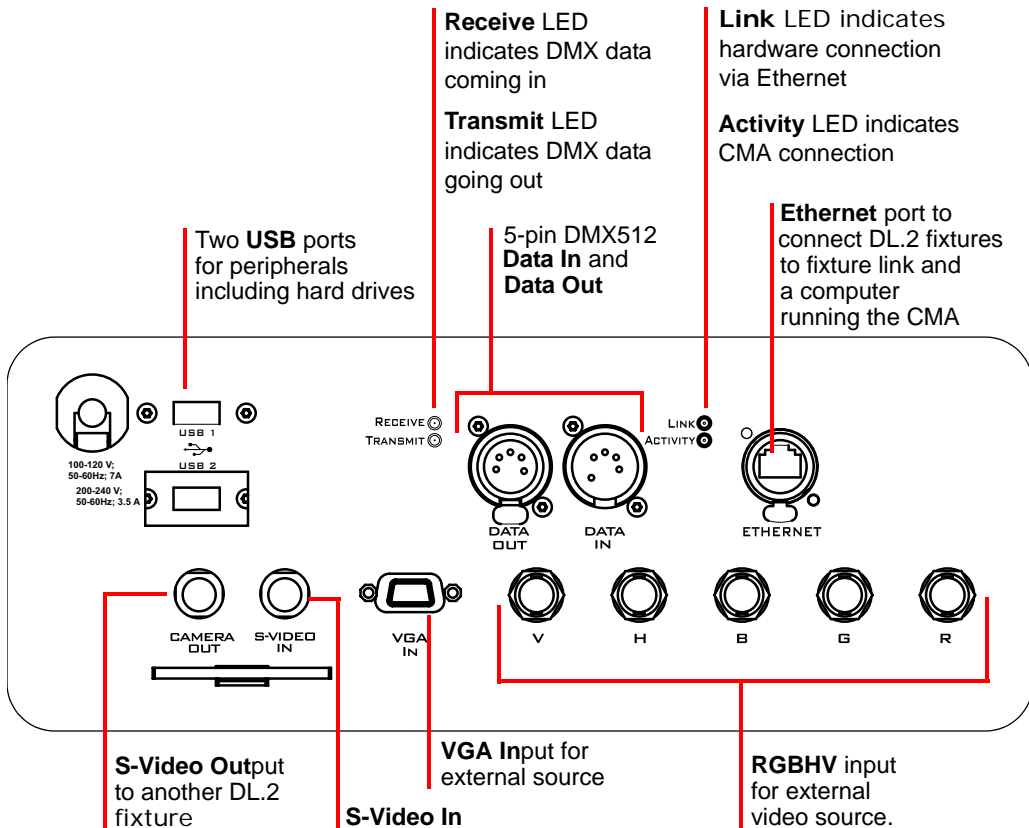

CAUTION:

To avoid damaging the fixture and voiding the warranty, do not physically connect to the RGBHV and VGA inputs at the same time.

Pan and Tilt Locking

The DL.2 fixture ships with pan and tilt latches locked. You can unlock/adjust these latches to stabilize the fixture for mounting.

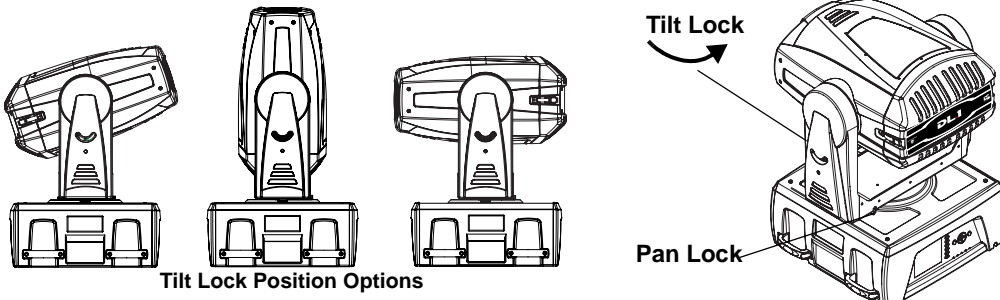

Note: *Disengage Pan and Tilt locks before operating the fixture.*

Attaching a Power Cord Cap

The DL.2 fixture ships with an SJT power cord. Use the information in this section to replace the power cord cap for locations with another electrical standard.

Because of the variety of power cord caps used worldwide, High End Systems, Inc. cannot make specific recommendations for the power cord cap. Contact a local authority for the type of power cord cap needed. When installing the power cord cap, note that the cores in the mains lead are colored according to the following code:

- green and yellow = earth
- blue = neutral
- brown = live

Installing a Line Cord Cap - U.K. Only

In the United Kingdom, core colours in the mains lead of this equipment may not correspond with the colored markings identifying the terminals in the fixture's plug. In that case, install a line cord cap according to the following code:

- Connect the green and yellow core to the plug terminal marked with the letter "E," or by the earth symbol \oplus or coloured green, or green and yellow.
- Connect the blue core to the terminal marked with the letter "N" or coloured black.
- Connect the brown core to the terminal marked with the letter "L" or coloured red.



WARNING:
Class 1 equipment - This equipment must be earthed.

Vatic Fitter Heads Information - Danmark

Advarsel: Beskyttelse mod elektrisk chock.

Vigtigt!

Lederne med gul/groen isolation maa kun tilsluttes en klemme maerket



eller



Mounting the Fixture

You can mount DL.2 fixtures suspended from a support system (such as a truss) or freestanding on its base.



WARNING!

Equipment suitable for dry locations only. Do not expose this equipment to rain or moisture.



CAUTION!

This fixture must be installed and operated by trained personnel only.

Always use a secondary safety cable when mounting this fixture.



Maintain a minimum focus distance of 1.4 meters from a combustible object.



Do not mount on a flammable surface.

Note: *Due to the wide variety of possible lighting designs, High End Systems cannot make specific mounting recommendations. Consider the following procedure as a suggested guideline only.*

Fog Machine Warning

Like all high quality video projection units, the DL.2 fixture must be kept protected from excessive amounts of glycol fog, mineral oil, and smoke. DL.2 incorporates a two-stage air filtering system with additional washable prefilters in the head and base housing to reduce these risks to a minimum. However, you must follow these guidelines to ensure continued operation of the fixture:

- Air filters (both fixture and projector) should be checked and cleaned on a regular basis. When used in a closed or fixed environment where fog or haze is used, we recommend at least a weekly check.
- Do not situate DL.2 in areas of high fog density such as directly in front of a fog machine or mineral oil hazer.
- Minimize the exposure of DL.2 to both glycol fog and mineral oil.

DL.2 is a highly complex and sensitive electro-optical device and care and thought in how it is used, rigged, and positioned will maximize the product's life and your investment.

Note: *Failure to follow these guidelines and carry out regular maintenance will void the warranty.*

Mounting the Fixture Upright



CAUTION!

Do not mount the fixture upright without the four rubber feet attached.

To mount the fixture upright, place the fixture on a sturdy, stable surface that will support more than the 53.5 kg (118 lb) weight of the DL.2 fixture. If the surface is above floor height, use safety cables to secure the fixture to the surface.

Disengage Pan and Tilt locks before operating the fixture.

Truss Mounting

When mounting the fixture on a truss or another type of support:

- Verify the truss or support will handle the combined weight of all the devices on the truss.
- Always mount the DL.2 fixture with the mounting bracket assembly that shipped with your fixture and a safety cable attached (using the mounting bracket) to the fixture's base.



WARNING!

Before mounting, disconnect power to the fixture. If it has been operating, allow the fixture to cool for five minutes before handling.



CAUTION!

Only experienced lighting personnel should attempt to hang a lighting fixture to an appropriate theatrical truss.

Do not use C- Clamps to mount the DLHD fixture to truss.

WARNING!

In all cases a safety cable should also be fixed between the safety cable mounting point located at the bottom of the fixture base housing and the truss. Failure to use a safety cable could result in injury or death. High End Systems supplies the proper safety cables and may be contacted for replacements if necessary. For more information go to: www.highend.com/trussing

Use the following steps to mount a DL.2 fixture on a standard truss:

1. Due to its size and weight, at least two people should support the fixture while another attaches clamps and safety cables. Always stand on a stable surface when mounting a fixture to its support.

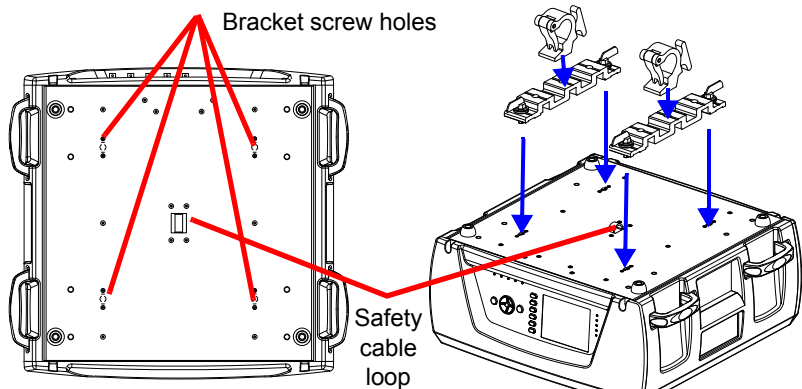

2. Mount the clamps that shipped with fixture to the mounting brackets and then attach the two mounting brackets to the base of the fixture using the provided quarter-turn screws.
3. Tighten the clamps firmly to the fixture's base and to the support.
4. Run the safety cable through the loop on the fixture's base, and around the truss.

Note: *High End Systems does not recommend operating the DL.2 fixture with the base perpendicular to the stage floor (fixture mounted sideways). This mounting orientation will result in significantly decreased lamp life.*

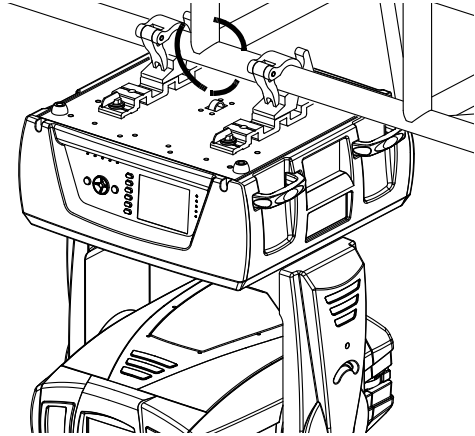

5. Disengage Pan and Tilt locks before operating the fixture.

Linking DL.2 Fixtures

DL.2 fixtures should be linked to a standard DMX512 link for control by a DMX desk as well as a Ethernet fixture link for CMA functions. The number of fixtures you can connect to a DMX link are determined by the combined number of channels required by all the fixtures. The DMX channel footprint of a DL.2 fixture is determined by the Protocol and the number of Graphic Objects you select for control. For more information on channel footprints for different configurations of DL.2 fixtures, see *DL.3 and DL.2 Version 2 DMX Channel Assignment* on page 319.

Use data-grade cable and 5-pin XLR cable connectors. For cable and connector specification, see *Cables and Connectors* on page 359. Test each cable with a voltage/ohm meter (VOM) to verify correct polarity and to make sure that the negative and positive pins are not grounded or shorted to the shield or to each other.



CAUTION!

Do not connect anything to the ground lug on the XLR connectors. Do not connect or allow contact between the common (cable shield) and the fixture's chassis ground. Grounding the common could cause a ground loop and/or erratic behavior.

To link one or more fixtures to a DMX controller:

1. Connect the male XLR connector of a DMX Data cable to the controller's DMX Data Out connector.
2. Connect the Data cable's female XLR connector to the Data In connector of the first (or next) fixture on the DMX link.
3. Continue linking the remaining fixtures connecting a cable from the Data Out connector of each fixture to the Data In connector of the next fixture on the link.
4. Connect a male terminator to the Data Out connector of the last fixture in the link (see *Powering On the Fixture* on page 12). For information on obtaining a terminator, see *Related Products and Accessories* on page 4. You can construct a terminator according to the specifications listed in *Cables and Connectors* on page 359.

Setting up an Ethernet Fixture Link

DL.2 fixtures utilize an Ethernet network to synchronize playback and access the CMA software for remote content management and fixture configuration. If you are using a DMX console and other automated lighting products compatible with Art-Net, this network can also serve as the link for DMX control.

Linking Configurations

The following diagrams show configuration options for linking DL.2 fixtures to each other via Ethernet for accessing the Content Management Application running on your computer, and to the DMX512 link for DMX desk control.

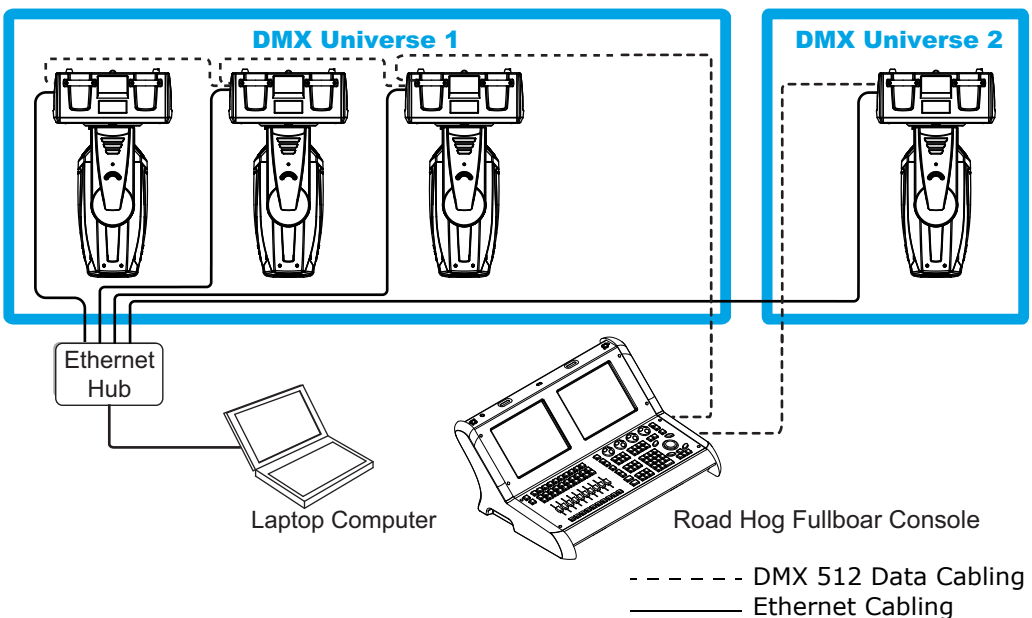

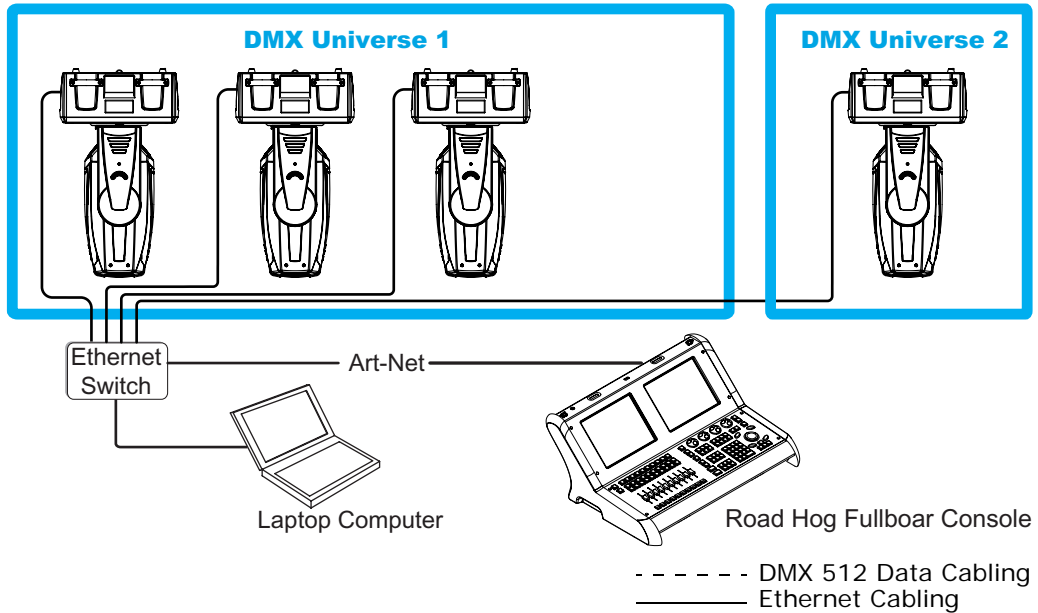

Configuration Option 2

Powering On the Fixture



WARNING:

This equipment is designed for connection to a branch circuit having a maximum overload protection of 20 A.



CAUTION:

Do not power on the fixture until *verifying* that the line cord cap is suitable for the power source in your location. For more information, see *Attaching a Power Cord Cap* on page 7.

Disengage Pan and Tilt locks before operating the fixture. For more information, see *Pan and Tilt Locking* on page 7.

To power on the DL.2 fixture, simply connect it to an appropriately-rated power source.



CAUTION:

Always isolate DL.2 media servers from generators with a UPS or good quality power conditioner to prevent damage occurring to the integrated media server and projector housed in the DL.2 from generator drop-outs, and sharp voltage and frequency fluctuations.

Homing the Fixture

When the DL.2 fixture is connected to an appropriately-rated power source, it automatically begins a homing procedure to verify that the major functions of the fixture and its internal projector are oriented properly.

Shortcut: *Holding down the inner most (i.e. middle) two menu tab buttons for more than two seconds will home the unit.*

The DL.2 Menu Display Panel

The DL.2 display panel gives access to the fixture's onboard menu system. *Chapter 3: The Digital Light Menu System* describes the menu system configuration options in detail.

Note: *Most configuration features are also available through the CMA, (see DL.3 and DL.2 Media Server Configuration Options on page 276.)*

Software Setup

Software setup for DL.2 fixtures requires the following steps:

1. **After powering on the DL.2 media server, launch the CMA software.**
2. **Check the software version installed and upgrade if necessary.**
3. **Configure the DL.2 fixture's DMX source, DMX protocol, and DMX Start Channel.**

Installing and Launching the Content Management Application (CMA)

The Content Management Application software that shipped on CD with your fixture communicates remotely with all DL.3, DL.2 and Axon media servers over an Ethernet network to:

- Upload and download custom digital content to fixtures
- Remotely control all menu commands
- Update software

Axon media servers can run the CMA directly. If your fixture network is linking DL.3 and DL.2 fixtures only, you will need to run the CMA on a computer connected to the Ethernet link you have established.

The following are the minimum hardware requirements for a remote computer running the CMA:

- Windows XP, Vista, Windows 7 (32 and 64 bit) or Mac OS 10.6 or later
- Microsoft Framework 2.0 or later
- 100/1000 base Ethernet card (a Gigabit Ethernet card is recommended for fast content uploading of large files)

After setting up an Ethernet network and linking all DL.2 fixtures and your computer, insert the CD that shipped with your fixture to automatically install the CMA on your hard drive.

For more information on CMA operation, see *Chapter 16: Content Management Application (CMA)* on page 245.

NOTE: *If the CMA doesn't automatically launch, navigate to the CMA.msi file in your Windows browser and double click to launch.*

When you launch the CMA, it automatically finds and identifies all DL.3, DL.2 fixtures and Axon media servers connected to the fixture link.



The screenshot shows the CMA software interface. On the left is a tree view under 'All Servers (6 servers)' listing various server models and their counts. On the right is a table with columns for Server ID, Server Name, IP Address, Software Version, and Model.

Server ID	Server Name	IP Address	Software Version	Model
1	00111140BFD7	10.2.102.20	1.3.3.1309	DL2
5	Axon One	10.2.102.21	1.3.1.1208	Axon
4	DL.2 Four	10.2.102.24	1.3.4.1331	DL2
1	0018F30543DF	10.2.102.27	1.3.4.1331	DL2
2	DL.2 Two	10.2.102.26	1.3.4.1331	DL2
5	Axon Two	10.2.102.23	1.3.4.1331	Axon

NOTE: To avoid problems with fixture communication over the Ethernet link, disable all firewall programs on your computer when using the CMA.

Verifying and Upgrading Fixture and CMA Software

Fixture and CMA software are continuously being updated to increase performance and add new features. The software loaded on your fixture may not be the most up to date. The latest fixture and CMA software are always available at the High End Systems website.

CMA software version is noted upon installation and can be accessed after that under the **File** menu.

The CMA **All Servers** view lets you view the fixture software version on all DL.3, DL.2 and Axon media servers linked to it via Ethernet.

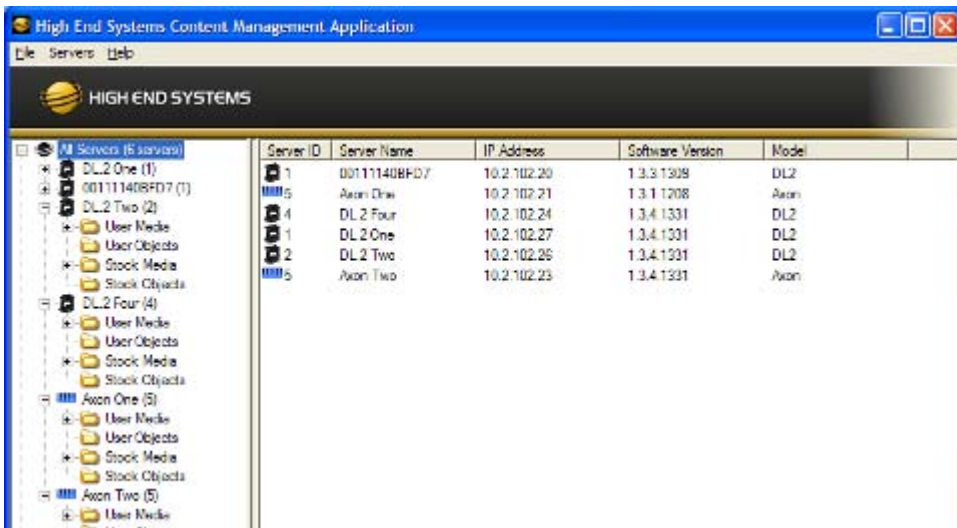

You can also view the installed software versions by navigating to the **Info_ Version** screen of a DL.2 fixture's menu system.

For downloading and upgrading CMA or fixture software, see *Upgrading Software* on page 270.

Software Version	2.0.0.2379
Firmware Version	1.5.4.156
Windows XPe	2.2.0
Pan Encd Version	1.0
Tilt Encd Version	1.0
Unique ID	92902AA1
Fixture Name	DL.3 one
IP Address	169.254.153.131

Configuring DL.2 Fixtures

Before programming the DL.2 fixtures from a DMX512 console, configure the fixture by:

- Identifying the **DMX Source** for the fixture.
- Selecting the **Protocol** and the number of Graphic Objects to determine the DMX channel footprint this fixture will utilize.
- Selecting a **Fixture ID** number to identify this fixture on the DL.2 fixture link (required if you will be synchronizing output between fixtures).
- Assigning a valid **Start Channel** (the first channel in the unique range of DMX channels designated by the console for this fixture).

You can configure fixtures directly using the DL.2 menu system or remotely using the Content Management Application (CMA).

Setup Configuration Using the Menu System

All setup parameters are located on the DL.2 fixture's menu **DMX Screen**. For detailed information on using the DL.2 Menu System, see *Chapter 3: The Digital Light Menu System* on page 21.

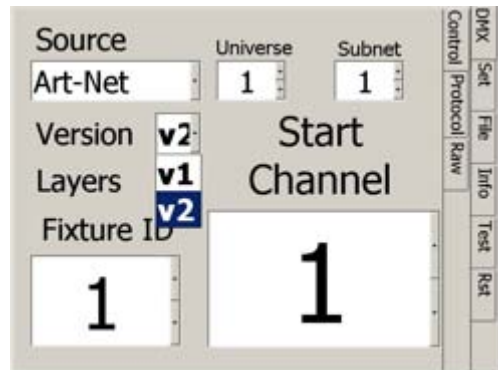

Select a Source

1. DMX Source defines the source of DMX data:

- **DMX512**—Data is transmitted over standard DMX cables.
- **Art-Net**—Data is transmitted over Ethernet cables using the Art-Net protocol. Set the number of DMX Universes (and DL.2 Ethernet Subnetworks containing this fixture from 0–16).

Set the Channel Range

2. Choose a Software Version.

- **V1**—Version 1 protocol retains the original DMX protocol footprint and is compatible with legacy shows.
- **V2**—Version 2 provides 27 additional channels.

3. Select the number of Graphic Object Layers required for your application. For more information, see *Protocol Options* on page 55.

DL.2 Start Channel

4. Select a **Start Channel** in the Start Channel field using the up and down arrows to step through the numbers 1-512. See *DL.2 Channel Range and Valid Start Channels* on page 18. For more information, see *Determining a DMX Start Channel* on page 40.

Setup Configuration Using the CMA

The Content Management Application running on your computer and linked to DL.2 fixtures via Ethernet lets you remotely configure the DL.2 fixtures. For more information on the CMA, see *Chapter 16: Content Management Application (CMA)* on page 245. All the setup configuration selections for DL.3 and DL.2 fixtures can be made in the **Server** tab.

To view configuration information for a individual server, click on **All Servers** in the left pane of the CMA window and select the + to view all the servers on the fixture network. Select a server in the left pane to view its configuration information in the right pane.

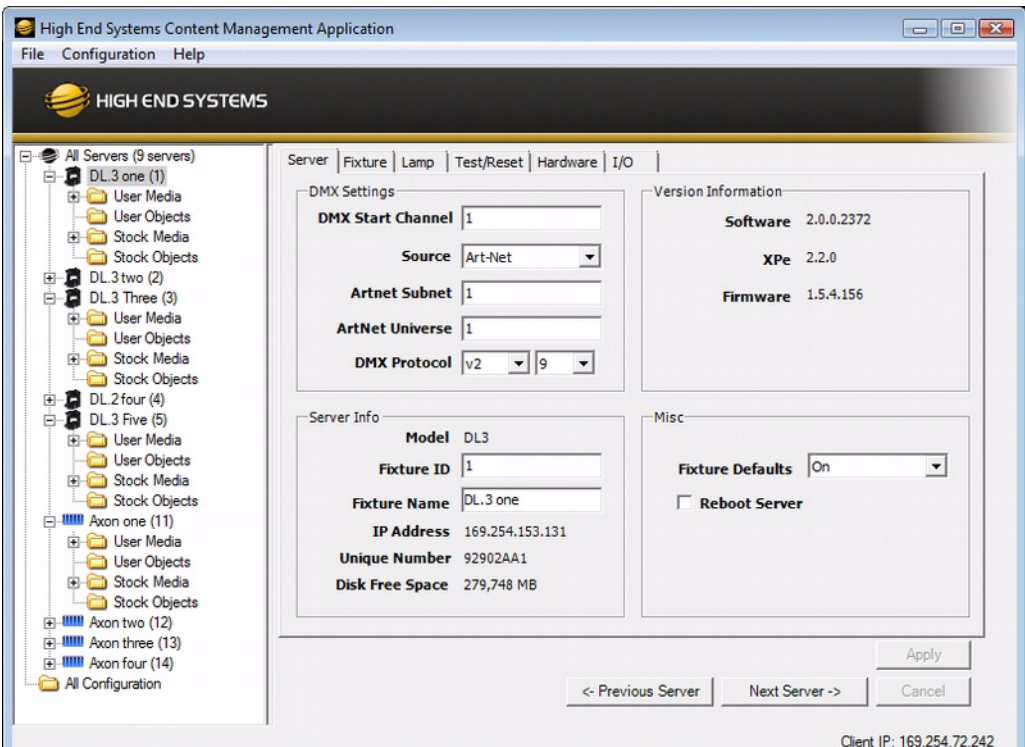

Select a Source

1. Select a DMX Source type by clicking on the down arrow of the Source field to select DMX512 or Art-Net.

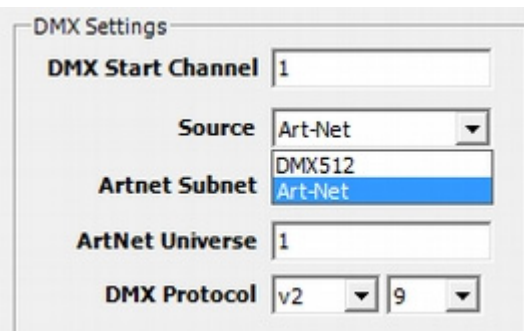

Set the Channel range

2. Select a **DMX Protocol** type by choosing **V1** or **V2** from the drop down list in the option field and select the number of Graphic Objects you want to use in your application:
 - **V1**—Version 1 protocol retains the original DMX protocol footprint and is compatible with legacy shows.
 - **V2**—Version 2 provides 27 additional channels.

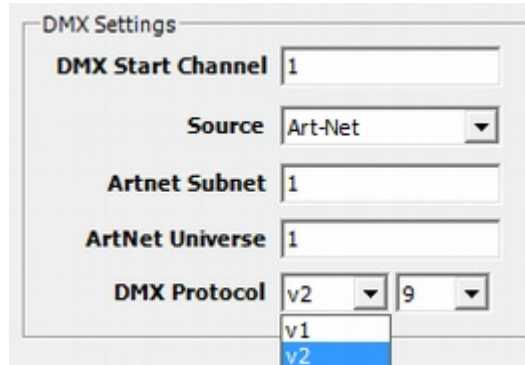

3. Select the number of Graphic Object Layers required for your application in the drop down field next to the protocol.
4. Enter a valid Start Channel in the Start Channel field.

For more information, see *Determining a DMX Start Channel* on page 40 and *Protocol Options* on page 55.

DL2 Channel Range and Valid Start Channels

# of Graphic Object Layers	Version 2		Version 1	
	Fixture Footprint	Last Valid Start Channel	Fixture Footprint	Last Valid Start Channel
0	76	437	56	457
1	121	392	94	419
2	166	347	132	381
3	211	302	170	343
4	256	257	208	304

DMX Control Setup

Patching the DL.2 Fixture to a Wholehog Console

Wholehog console library systems patch the DL.2 fixture as three to six “fixture types”. When using Wholehog software: add one motion, one global, and multiple graphic “fixtures” for each complete DL.2 unit in the *Fixture Schedule* or *Add Fixtures* wind (DL.2 #1 with user number 1 = motion, 2 = global, and 3 to 6 = graphic fixture types).

Viewing Output

To output an image from a DL.2 fixture:

1. Open the Dimmer on the motion fixture and set the Global Intensity parameter to full.
2. Set the Object Opacity parameter for the selected object to full.

When programming with Wholehog software, the Media Folder and Object parameters default to 1, so choosing any Media File value between 1 and 37 displays a media loop from the HES Core folder (Media Folder 1) on a flat 4x3 rectangle (Object 1). The **Dimmer**, **Global Intensity**, and **Object Opacity** parameters all need values greater than zero for an image to be visible.

NOTE: *If you have trouble viewing output and you are not using a lighting console from High End Systems, check that the library for your desk has the correct default settings for all DMX channels.*

Shutting Down the Fixture

Recommended Shutdown Options

There are two recommended ways to shutdown the fixture:

1. A DMX controller can shut down the fixture’s motion controls and projector remotely with the shutdown option of the control channel (see *Fixture Operations* on page 238).
2. The DL.2 fixture automatically shuts down in the event of DMX data loss. The default time is 10 min.



WARNING:
Removing power directly without the shutdown sequence built into the two recommended procedures can severely reduce fixture reliability.

Placing Fixture in Road Case

Before shipping the DL.2 fixture, lock its pan and tilt position so the fixture does not move during transit.

To lock the fixture:

1. Orient the projector head pan position as shown for packing in the road case and secure with the pan lock located on the yoke base.

Note: *This is the only pan position that locks.*

2. Move the tilt lock peg to the upper left (locked) position.
3. Gently move the projector head and yoke to verify that both pan and tilt positions are locked in place.
4. Place the DL.2 fixture in its provided road case for shipping.

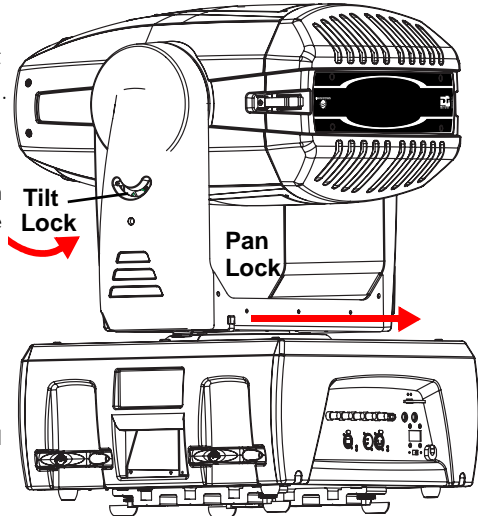

1. Place Top over the fixture first

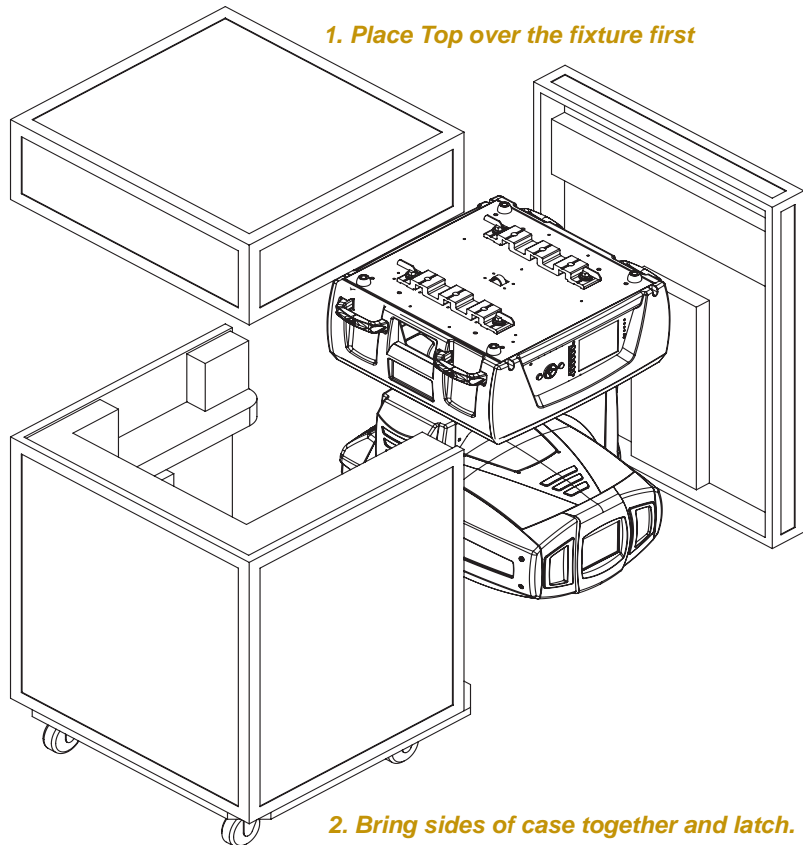

2. Bring sides of case together and latch.

Chapter 3:

The Digital Light Menu System

DL.3 and DL.2 digital lights have an onboard Menu System you can use to configure the fixture, review diagnostic feedback, and view content information.

DL.3 and DL.2 fixtures use a 5" LCD screen to display the onboard menu system. Navigation and select buttons let you move to different tab levels and options displayed on the Menu screen.

NOTE: You can access most Menu options through the CMA (see Chapter 16: Content Management Application (CMA) on page 245.) You can also remotely control certain options via a DMX console using the Control channel (see Control Function Options on page 238).

Menu Panel Components

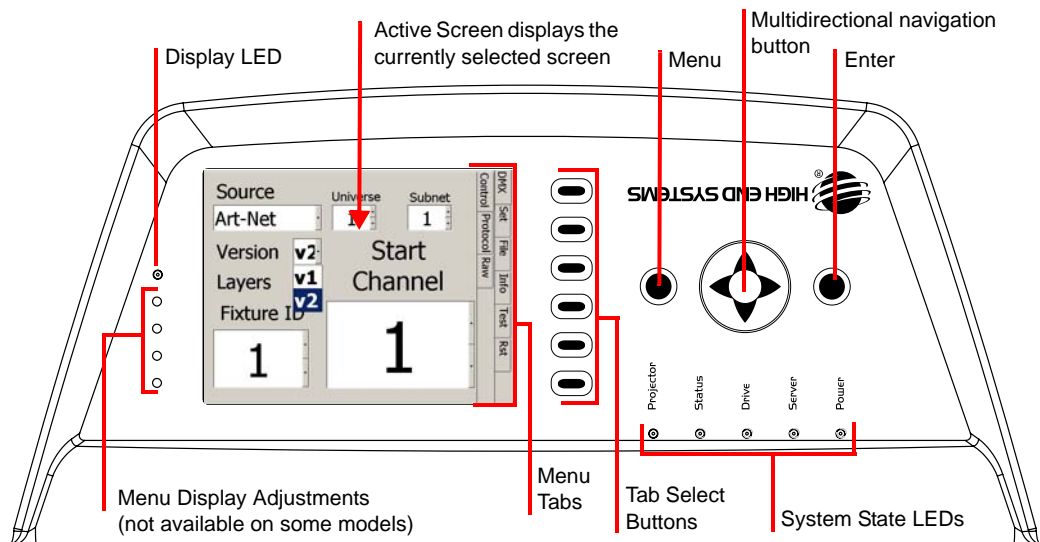

The LCD screen displays the menu system arranged with a series of **Menu Tabs** along the side for accessing configuration screens and options on the currently active screen. Clicking on one of the **Tab Select** buttons selects the screen tab next to it.

The large Multidirectional **Navigation** button controls movement between fields. Use the **Menu** button right of the **Navigation** button to access the Menu system or to cancel a selection. The **Enter** button left of the **Navigation** button selects and stores a selection.

Functionality for the **Menu** and **Enter** buttons automatically reverses when the fixture is rotated to keep operation consistent. You can also manually set this option (see *Display Options* on page 31).

The fields in the **Active Screen** display current settings and provide drop down boxes, numeric up/down selectors, and other user interface options to select in editable fields.

LCD Display Adjustment Buttons

A display LED and four display adjustment buttons are located next to the Display screen. The **Display LED** is green whenever the Menu Display is on, even if it is dimmed to video black. LCD Display adjustment buttons control and provide visual adjustments for the menu display.

NOTE: *These adjustments are not available for some display models.*

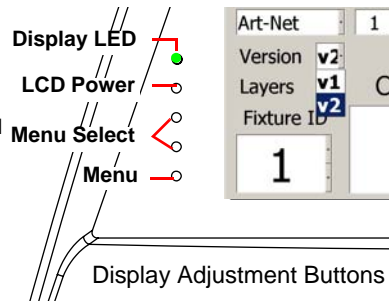

LCD Display Power Button

The button nearest the green LED is the **LCD Power** button. Holding it down for two seconds turns the Menu display on or off. Use this in situations when you need to turn the Menu display completely off instead of dimming it to video black.

If you turn the LCD screen off and then remove power to the Digital Light, the **LCD Power** will restore the default (ON) when you reapply power to the fixture.

NOTE: *The LCD Power button doesn't affect power to the fixture or the internal projector.*

LCD Display Menu Options and Selection

The button farthest from the Display LED is the **Menu** button. Pressing this brings up the different functions contained in the LCD screen itself. The screen menu options are:

- **Picture** adjusts the sharpness of the screen
- **Color** adjusts the richness of the color
- **Contrast** adjustment
- **Black Level** adjustment
- **Tint** adjustment
- **Restore** returns the screen to the factory defaults

The two **Menu Select** buttons are used to adjust the currently selected function.

NOTE: *Display Black Level can also be controlled by the menu system (see Set Tab on page 31) or remotely through the configuration options in the CMA (see DL.3 and DL.2 Media Server Configuration Options on page 276.)*

Navigating the Menu

Select any Menu tab by pressing the corresponding button to the side of the display. A tab will be bold when selected. Use the left and right arrow keys on the navigation buttons to move to the Sub Menu tab column.

Press the Tab select button that corresponds to the Sub Menu tab you want and press the **<Enter>** button to select.

Use the multidirection button to move left/right/up/down to a field. The currently selected field will be highlighted.

Press the **<Enter>** button to go into edit mode for the selected field. A list box will open to show all the options for that field.

Use the Up/Down keys to scroll through the items in the list highlighting the current item. Pressing the **<Enter>** button again stores the selection and closes the list.

Pressing the **<Menu>** button instead of **<Enter>** leaves the original setting and closes the list.

To return to the Menu tab column, press the left direction on the Navigation button.

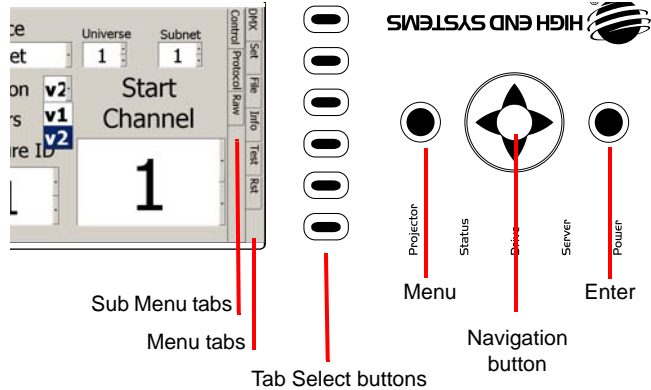

Menu Options

The menu display consists of a set of top-level tabbed screens and their associated subtabs.

Main Tab	Sub-Tabs/ Screens	Fields Controls	Options	Function/Notes
DMX	Control	Source	DMX512	Sets DMX as fixture communication source
			Art-Net	Sets Art-Net as fixture communication source. You need to identify the Universe and Subnet by selecting a number from 0-16 in their corresponding field.
		Protocol	V1	V 1 protocol retains the original DMX protocol footprint and is compatible with legacy shows.
			V2	V 2 provides 27 additional channels.
		Layer Box	0-9	Selects the number of Graphic Objects from 1–9
		Fixture ID	1-255	Assigns the fixture a unique number on fixture network for use with Synchronization feature
	Start Channel	1-512	Sets the fixture's DMX Start Channel	
	Protocol View	Motion	Displays current fixture Movement and Camera parameter values (<i>camera parameters not active in DL.3F model</i>)	
		Global	Displays current parameter values for the composite image	
		1 - 9 (graphic objects)	Displays current parameter values for the selected graphic object	
	Raw View	Main Table	Displays current DMX values for all 512 DMX link channels in rows of values.	
		Offset	Scrolls through rows of DMX values	
		Refresh Rate	0-44	Displays the # of DMX packets received / second
Refresh Timer		On	DMX values updated instantly	
		Off	Display does not refresh	
Set	Fixture	Pan Invert	On	Inverts the direction of the pan motor.
			Off	Default
		Tilt Invert	On	Inverts the direction of the Tilt motor.
			Off	Default
		Pan/Tilt Swap	On	Swaps Pan and Tilt directions
			Off	Default
	Data Loss Timeout Iris	Long	Closes iris after a 5 minute DMX data loss	
		Short	Closes iris after a 5 second DMX data loss	
	Display	On	Default intensity adjustment	<i>NOTE: Unless you select Off, you can adjust display intensity level from 0 - 100%.</i>
Preview		Displays current content preview		
Off		Turns off display after a period of time		

Main Tab	Sub-Tabs/ Screens	Fields Controls	Options	Function/Notes	
Set	Fixture	Display Invert	On	Inverts menu display and navigation	
			Off	Turns off the display invert	
			Auto	Automatically inverts display when fixture mounting is greater than 45°	
		Factory Defaults	On	Restores factory default settings	
			Off	Default	
	Projector	Projector Lamp	On	Manually turns Projector Lamp on	
			Off	Manually turns Projector Lamp off	
		Projector Powerup	Always	Turns the projector lamp on whenever the fixture is connected to power	
			Manual	Turns on the lamp when Projector Lamp = On	
			DMX	Turns the projector lamp on with DMX input (default)	
		Zoom Override	On	Overrides the DMX values sent by the console. Set value manually from 0-255	
			Off	Default	
		Focus Override	On	Overrides the DMX values sent by the console. Set value manually from 0-255	
			Off	Default	
		Projector Ceiling	On	Rotates the image 180° around the x-axis	
			Off	Default	
		Projector Rear	On	Rotates the image 180° around the y-axis	
			Off	Default	
		Lens Type	Standard	Selects the lens currently installed in the projector.	
			Long		
			Ultra Long		<i>NOTE: these options are active for DL.3 fixtures only</i>
			Wide		
	Projector Defaults		Clicking the Reset button restores Factory Projector Defaults		
	I/O <i>(not available in DL.3F fixtures)</i>	Projector Input	External	Chooses the input the Projector will accept	
			Internal		
		Projector In by DMX	Yes	Selecting Yes allows projector's input source to be selected from DMX	
			No	Disables changing projector input via DMX	
		S-Video Input	Internal	Accepts S-Video signal from the DL.3 onboard camera input	
			External	Accepts S-Video signal from another DL.3 or video source	
	External SVideo Format		Options dependant on the fixtures video card configuration		
	SDI Format				
	File				Displays content file locations and allows a content preview <i>(see page 38)</i> .

Main Tab	Sub-Tabs/ Screens	Fields Controls	Options	Function/Notes	
Info	Hours	Lamp Hours		Monitors lamp hours of operation. Selecting Reset button reverts hours to 0.	
		Fixture Hours		Monitors fixture hours of operation. Selecting Reset button reverts hours to 0.	
	Version	Software Version		Displays currently installed versions	
		Firmware Version			
		Windows XPe			
		Pan Encoder Version			
		Tilt Encoder Version			
		Unique ID		Displays the unit's factory assigned ID number	
		Fixture Name		Displays a currently assigned Fixture Name	
		IP Address		Displays fixture's IP address	
		Projector Type		Displays projector model	
		Video Adaptor		Displays video adaptor card model	
	Status	Motion Shutdown		Displays system activity and errors. For more information, see <i>Chapter 17: Maintenance and Troubleshooting</i> on page 297,	
		Projector Status			
		Projector Air Filter			
	Hardware	CPU	Q9550		Identifies the currently loaded hardware components
			Q6600		
			E6600		
			P4-3.2		
		Motherboard	Intel D915FUX		
Asus P5BV-VM					
Asus P5Q-EMTDO					
Video Adapter		X850			
		X1900			
		X1950			
		HD-2900			
		HD-4850			
Hard Drive					
Projector Type		LX50			
		LX55			
		LS650			

Main Tab	Sub-Tabs/ Screens	Fields Controls	Options	Function/Notes
Info	Hardware	S-Video Capture	X850	Identifies the currently loaded hardware components
			X1900	
			X1950	
			HD2900	
			HVR-1800	
			HVR-1600	
		SDI Capture	Decklink	
			NA	
Test	Home	Motion All		Clicking the Home button resets all mechanical functions to default positions
		Calibrate Motors		Clicking the Calibrate button recalibrates motors to correct misstepping or after installing new motor boards in system.
	Self Test	Self Test Pan/Tilt	On	Selecting On starts a test sequence for Pan and Tilt mechanical functionality
			Off	
		Self Test Iris	On	Selecting On starts a test sequence for Iris mechanical functionality
			Off	
		Self Test Zoom	On	Selecting On starts a test sequence for Zoom mechanical functionality
			Off	
		Self Test Focus	On	Selecting On starts a test sequence for Focus mechanical functionality
			Off	
Video Test	Off	Selecting a Video Pattern displays a sample video to test graphics engine functionality.		
	Test Pattern 1			
	Test Pattern 2			
Reset	Reboot Media Server		Clicking Restart reboots the internal media server	
	Delete User Content		Clicking Delete erases all User Content on server	
	Upgrade Factory Content		Clicking Upgrade installs updates to factory content (requires connection to the CMA)	

Menu Screen Descriptions

DMX Tab

The DMX Tab has sub-tabs for configuring the fixture for the DMX link, viewing the DMX settings for the fixture on each channel of its range, and viewing all 512 channel values on the DMX link.

DMX_Control Screen

Use the Control sub-tab to configure your fixture for a DMX link.

DMX **Source** defines the source of DMX data and has two options:

- **DMX512**—Data is transmitted over standard DMX cables.
- **Art-Net**—Data is transmitted over Ethernet cables using the Art-Net protocol. The Art-Net screen contains for setting the number of DMX Universes and Ethernet Sub-networks containing this fixture from 0–16).

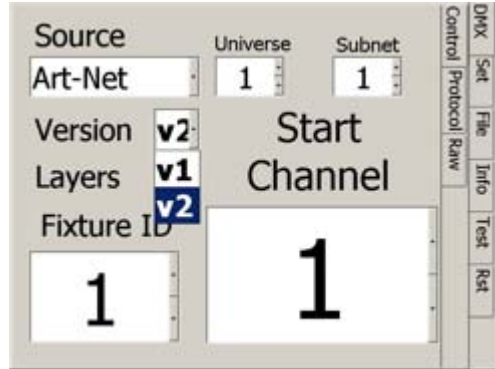

Select a **DMX Protocol** type by choosing **V1** or **V2** from the drop down list in the **Version** field and the number of Graphic Objects you want to use in your application in the **Layers** field.

- **V1**—Version 1 protocol retains the original DMX protocol footprint and is compatible with legacy shows.
- **V2**—Version 2 provides 27 additional channels to provide framing shutters, more banks of effects and 16-bit control of x, y and z scaling.

Both versions provide the latest Global and Graphic effect options and can control up to nine graphic objects for DL.3 fixtures and up to four graphic objects for DL.2 fixtures.

Edit the **DMX Start Channel** field by entering a valid Start Channel for the protocol and number of graphic objects you have selected.

Scroll through the numbers 1-512 in the **Start Channel** field to set a valid start channel for the protocol you have chosen. A valid start channel will allow the number of consecutive channels on the link needed for the protocol and number of Graphic objects you have selected. See *Determining a DMX Start Channel* on page 40.

You can assign each fixture a unique **Fixture ID** number from 1-255. This allows the fixture to be identified on the ethernet fixture link for tasks like synchronizing playback between Digital Light fixtures and uploading custom content with the Content Management Application (CMA). You can manually set this number in the menu or through the CMA, see *DL.3 and DL.2 Media Server Configuration Options* on page 276. Setting up an Ethernet Fixture Link is described in *Chapter 2: Setup and Configuration*.

DMX_Protocol Tab

The Protocol sub-tab displays the current DMX value being received from a console for each parameter after any conversion, such as internal self test or protocol conversion. The DMX parameters are grouped into general categories, each with a separate tab. For more information on individual parameters and their DMX value ranges, see *Appendix A: DMX Protocol on page 311*.

DMX_Protocol_Motion Screen

The **Motion** sub-tab displays parameters associated with fixture movement, projector control and integrated camera functionality.

NOTE: Camera parameters are present but not active in DL.3F models.)

For more information on specific Motion and Camera parameters, see: *Chapter 14: Fixture Motion Functions* and *Chapter 15: Live Video Input and Control*.

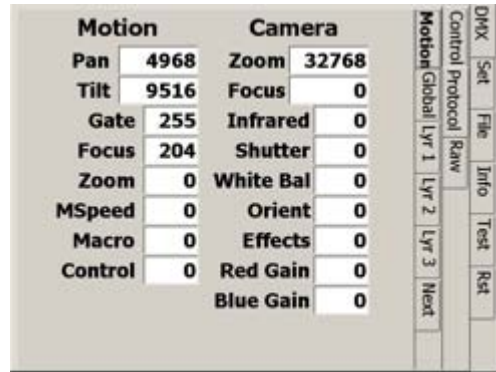

DMX_Protocol_Global Screen

The **Global** sub-tab display the current values for parameters that affect the composite image.

For more information on specific Global parameters, see *Chapter 11: Global Functions*.

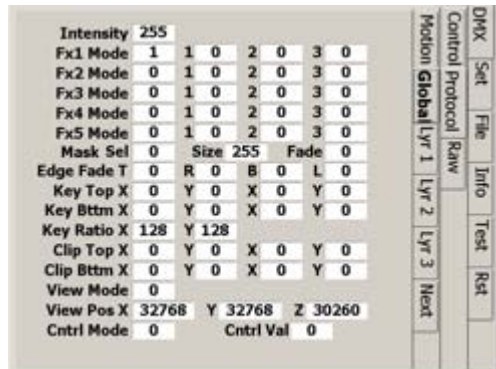

DMX_Protocol_Obj Screens

Object sub-tabs are labeled from 1 to 9 and display parameter values affecting a single object's content.

For more information on specific Graphic Function parameters, see: *Chapter 7: Graphic Functions: Defining Content*; *Chapter 8: Graphic Functions: Rotation, Position, Scale*; and *Chapter 10: Graphic Functions: Synchronizing Content*

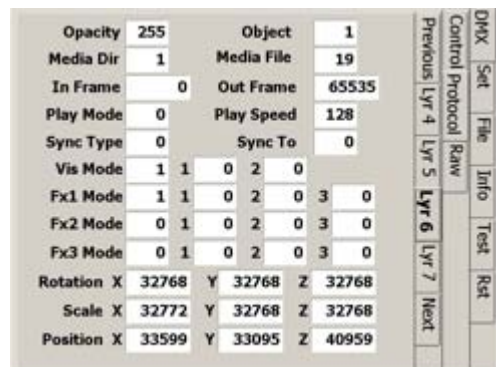

DMX_Raw Screen

Use the Raw sub-tab to view the DMX values of all fixtures on the link. The **Raw Tab** displays every DMX value for Channels 001–512 in lines of eight DMX values each per screen. The **Offset** number at the beginning of each line indicates the first DMX channel with a value displayed on that line. Use the scroll bar at the left of the offset number to scroll through all the values.

The **Refresh Rate** is the rate at which DMX is being received by the fixture.

With **Refresh Timer** set to **On**, you see the raw DMX values updated instantly. When **Off** is selected, you will see a **Snapshot** button. Each time you select **Snapshot** you see the screen frozen at the current values. Select **On** again to restart automatic refresh.

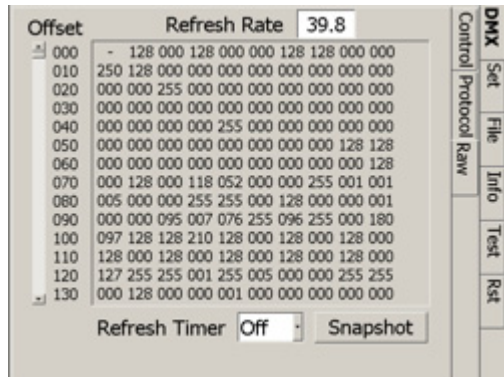

Set Tab

Set_Fixture Screen

The Fixture sub-tab provides options for selecting or changing fixture movement, dimming the mechanical iris, and controlling the LCD display black level and orientation.

Movement Option Fields

Set the **Pan Invert** option **On** to invert the direction of the pan motor. Use this option to coordinate movements between fixtures facing each other in a horizontal orientation. **Off** is the default setting.

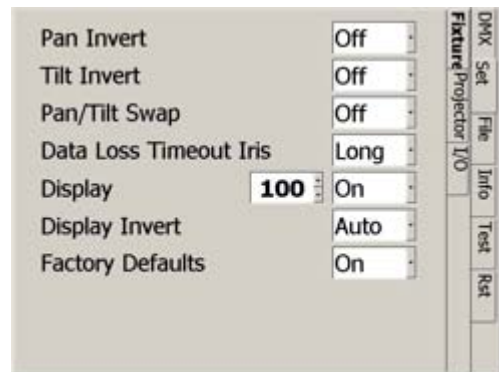

Setting the **Tilt Invert** field to **On** inverts the direction of the tilt motor. Use this option to coordinate movements between fixtures facing each other in a vertical orientation. **Off** is the default setting.

Setting **Pan Tilt Swap** field to **On** swaps the pan and tilt motor operation to coordinate movements between fixtures mounted perpendicular to each other. **Off** is the default setting.

Timeout Option

The Dimmer Iris closes when it stops receiving DMX data for a designated time interval. Use the **Data Loss Timeout Iris** field to set the DMX data loss time interval as **Long** (5 minutes) or **Short** (5 seconds). **Short** is the default setting.

After 10 minutes of no data, the fixture will shut down the projector and the motion functions. Fans remain on to maintain the temperature control for the internal graphics engine.

Display Options

The **Display** field lets you adjust the black level of the Menu display with the following options:

- **On** is the factory default.
- **Preview** displays the most recent media change of any Graphic function when opacity > 0. The Menu screen displays content in both partial and full screen. The Preview function can be enabled from the menu system, the CMA, as well as remotely via DMX.
 - When Preview is enabled, a partial, full color video is shown on the LCD display along with the folder, file, and DMX information. If there is no change of content on any Graphic Function it will automatically switch to full screen mode within 12 seconds.
 - The Preview function always shows the latest selected content without any modification of effects. Preview mode displays movies and still images only. S-video and internal camera input will not be displayed in the Preview mode.
 - The Preview function uses substantial memory and should be turned off when rendering multiple Graphic Object options to ensure high quality playback.

NOTE: After selecting the **On** or **Preview** option, you can use the numeric up/down control to adjust the Menu display brightness level from 25 (dim) to 100 (brightest).

- **Off** turns off the display after 20 seconds of inactivity. Touching any button on the fixture menu will re-enable the display.

The **Display Invert** field inverts the display and navigation control functions. This is useful in certain fixture orientations. There are three invert control options:

- **On** manually inverts the display and navigation buttons
- **Off** manually turns off the display invert function
- **Auto** sets the display to invert automatically when the fixture is rotated more than 45% off the horizontal axis. This is the default setting.

Restoring Factory Defaults

Selecting **On** in the **Factory Defaults** field restores all factory default fixture settings.

Set_Projector Screen

The Projector sub-tab provides settings related to the internal projector functionality.

Projector Control

Projector Lamp field lets you manually turn the lamp **On** or **Off**.

Use the **Projector Powerup** field to choose the control option for turning the lamp on. The options are: Always On, Manual, and DMX. This only takes effect when the fixture powers up.

- **Always On** turns the projector lamp on when the fixture starts up regardless of whether there is a DMX/Art-Net signal. If there is no DMX/Art-Net signal the lamp shuts off when the shutdown timeout period expires.
- **Manual** turns on the projector lamp only when set to On via DMX, Menu or the CMA.
- **DMX** only turns the lamp on when it receives a DMX signal or Art-Net signal.

When the internal projector menu is selected for display, you may need to manually adjust the zoom and /or focus parameters to view the display clearly. Setting the **Zoom Override** or **Focus Override** options to **ON** overrides the DMX values sent by the console and allow you to control Zoom and Focus manually with a DMX decimal value between **0-255**.

Projector Ceiling rotates the image 180 degrees. **Projector Rear** projects a mirror invert of the image for rear-screen projection applications.

Selecting **ON** in the **Projector Defaults** field resets all the options on the Projector tab to their factory default settings. For more information, refer to the *Projector User Manual* that shipped with your fixture.

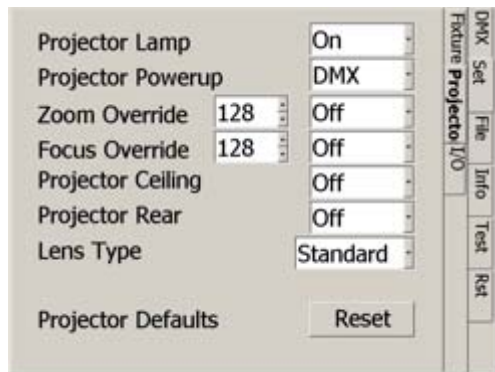

Lens Type Options (DL.3 fixture only)

There are three accessory lenses available for the DL.3 Digital Light. The default setting for the **Lens Type** field is Standard. When you install a **Long** throw, an **Ultra Long** throw, or a **Wide Angle** lens, you will need to select that lens type to configure your system.

NOTE: *The Lens Type field is not active if you are operating this version of the software on a DL.2 fixture.*

Set_I/O Screen

This screen lets you select the Input and Output options for the fixture.

Use the **Projector Input** field to select which input the projector should accept. When **External** is selected, the projector takes input directly from an external source and bypasses the internal graphics engine. When **Internal** is selected, the projector takes input directly from the graphics engine. Internal is the default configuration setting.

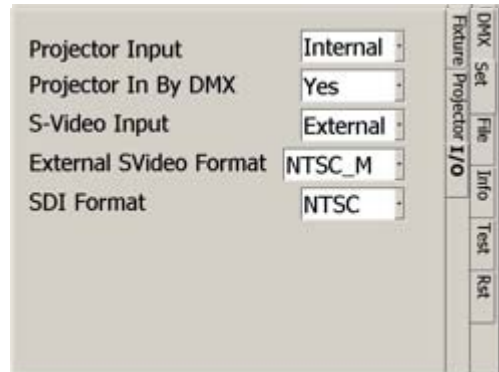

Projector In By DMX toggles the ability to set the projector input via the Control Console. **Yes** is the default and allows the input to be changed via the console, **No** doesn't allow the input to be changed.

Video Format

- The **S-Video Input** field allows you to accept **Internal** S-Video signal from the DL.3 onboard camera input or **External** from another DL.3 or video source.
- The **External SVideo Format** field lets you choose which S-Video format the fixture will accept. Digital Light fixtures support multiple S-Video formats including:

NTSC_M	PAL_B	PAL_H	SECAM_B	SECAM_K
NTSC_MJ	PAL_D	PAL_I	SECAM_D	SECAM_K1
	PAL_G	PAL_M	SECAM_G	SECAM_L
		PAL_N	SECAM_H	SECAM_L1

Notes: *The format must be set to NTSC_M to receive input from the internal camera.*

This format is not available in the DL.3F model.

- The **SDI Format** field lets you select from the SDI formats supported.

File Tab

The **File** screen displays information about the currently selected content file. Use this screen to preview content — both still images and movies.

When you select the File tab, the file plays in the window to the left. The bottom right window displays content folders and highlights the current file location.

You can scroll through the Content folders and the files inside each folder to preview any content file.



Info Tab

The Info tab displays current fixture information such as hardware and software versions, sensor status, total fixture and lamp hours, and DMX errors. You can also reset Lamp and Fixture hours.

Info_Hours

The **Hours** tab displays the **Lamp** and **Fixture** hours of operation since the last reset. Clicking on the **Reset** button resets the associated hours to zero. **Lamp** hours should be reset to zero whenever a lamp is replaced.

Fixture Hours information is often used to track fixture hours for a show or a rental period. The number field displays the number of hours the fixture has been operating since the last reset. Pressing the Fixture Hours Reset returns the value to 0.



Info_Version Screen

This screen displays the current versions of the fixture's configuration components. You can compare these to the latest versions available on the DL.3 support page at www.highend.com.

Software Version and **Firmware Version** fields display the current versions loaded on this fixture.

Unique ID is a factory assigned ID for the media server.

Fixture Name field displays a name you assign in the Content Management Application for easy reference in developing your show.

IP Address is assigned to that unit by the router or Auto IP.

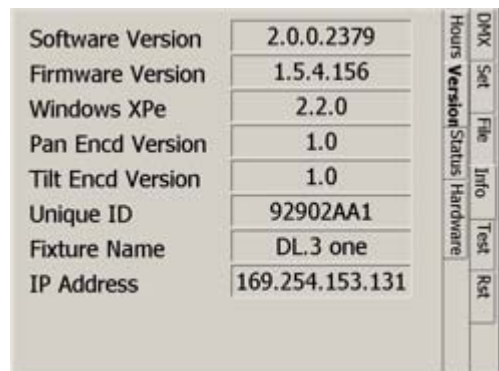

Info_Status Tab

This screen displays status errors and warnings on items including:

- Temperature
- Filter life
- Lamp life
- USB and Camera Communication
- USB Security

For more detailed information, see *Chapter 17: Maintenance and Troubleshooting* on page 297.

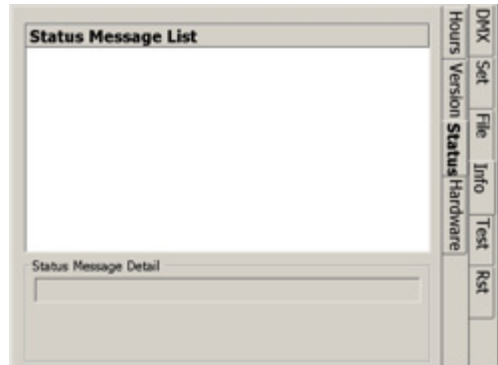

Info_Hardware Tab

This screen identifies the version of each of the fixture's hardware components.

Features such as supported video formats are dependent on the hardware configuration of your particular DL.3 fixture.

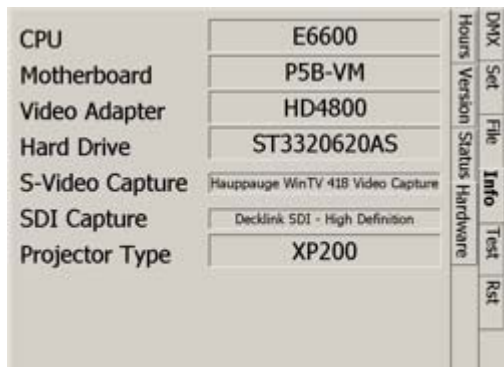

Test Tab

Test_Home Screen

Homing sets a fixture to its default positioning. The fixture automatically homes whenever it is connected to power.

Selecting **Motion All** lets you manually home the entire fixture.

Selecting the button for **Calibrate Motors** realigns the Pan and Tilt stepper motors after maintenance procedures.

The fixture can also be remotely homed via a DMX controller, (see *Control Function Options* on page 238) or through the Content Management Application, (see *DL.3 and DL.2 Media Server Configuration Options* on page 276).



Test_Self Test Screen

You can check the mechanical functionality of **Pan/Tilt**, **Iris**, **Zoom**, and **Focus** assemblies on the fixture head. Select **On** to start the test sequence.

The **Video Test** option opens the mechanical iris and provides test patterns to check the projection functionality. This lets you verify that the graphics engine is operating without having to use a DMX controller.

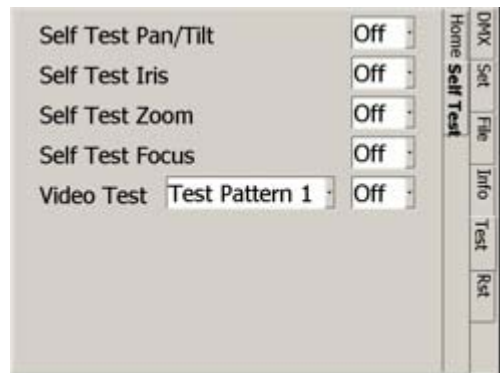

Reset Screen

The Reset screen provides buttons to reset, shutdown and upgrade software.

Reboot Media Server restarts the fixture's internal graphics engine software.

Delete User Content removes all user content on the selected fixture(s).

Upgrade Factory Content lets you reinstall factory content in a recovery situation.

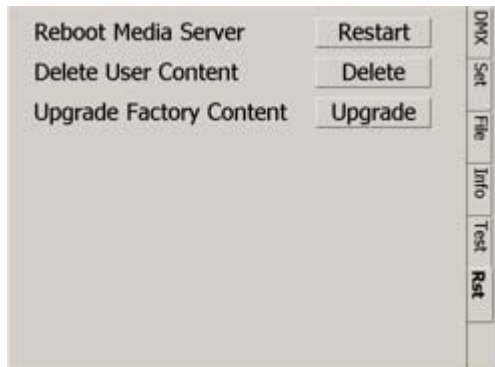

NOTE: *You can obtain a copy of the Factory Content from High End Systems customer service.*

Chapter 4:

DMX Programming Basics and Quick Start

If you are new to DMX programming, this chapter gives you a brief overview on programming DL.3, DL.2, and Axon media servers and an example of using a Wholehog console to patch and display output from a media server.

DMX Programming Overview

DMX512 Links

A lighting console typically utilizes a protocol called DMX512 to communicate with automated lighting fixtures and conventional dimmers. This protocol consists of 512 unique channels of control per output link (universe). Typically a lighting fixture or device will use a channel for each parameter's function. Each channel consists of 256 values ranging from 0 to 255. The lighting console is programmed to transmit a corresponding DMX value for the desired function of each parameter. All DMX values are stored within the lighting console, and typically are referred to as cues, scenes, or presets. A lighting console locates a device on the link by its DMX Start Channel.

8-bit vs. 16-bit DMX Parameters

Most parameters of an automated light use one channel of DMX providing 256 values of control (0-255). This is known as 8-bit DMX. Although most parameters use 8-bit DMX, several require a more accurate range of values than can be provided with a single DMX channel.

By utilizing two DMX channels for a single parameter, 65535 values become available for controlling and adjusting parameter functions. This is known as 16-bit DMX. You can adjust 16-bit DMX values in both coarse and fine increments. The first channel of the pair provides coarse control changes of the DMX value in increments of 256. The second channel provides fine control and changes of the DMX value in increments of 1.

Individual access of the two DMX channels used with 16-bit parameters varies by lighting console. Most modern DMX consoles bind these two channels into a single 16-bit parameter to accurately perform 16-bit crossfades. Consult your lighting console manual for further information.

Determining a DMX Start Channel

Overview

The DMX Start Channel is the first channel of a device's channel footprint on a DMX link. There are 512 available channels on each DMX universe divided among all the devices in a particular universe. A device must have a unique DMX channel range in order to respond independently to controller commands. The DMX Start Channel is the first channel in that fixtures channel range.

To determine each device's DMX Start Channel, identify the footprint of every device on the universe. The device's footprint is the number of consecutive DMX channels it requires and is determined by the channels in the fixture's protocol. The fixture's DMX channel footprint must not overlap any other device's channel footprint on the link. When two devices on the same DMX universe have overlapping channel footprints, one or both devices will be disabled or behave erratically.

Once you have determined the footprint of your device, a simple formula for finding the last valid Start Channel on a standard DMX512 link is:

$$512 - \text{the unit's channel footprint} + 1$$

Digital Lighting Products

The channel range for your Digital lighting product will depend on the model, the Protocol mode and the number of Graphic objects you select. DL.3 and new Axon media servers running Version 2.0 fixture software all provide individual and composite graphical control for up to nine Graphic Objects. DL.2 fixtures and original Axon servers can control up to four Graphic objects. You can influence the footprint of the fixture on a DMX link with the protocol you select and the number of graphic objects you implement.

#of Object Layers	V2 Footprint on DMX512 Link				V1 Footprint on DMX512 Link			
	DL.3	Axon	DL.2	Early Axon	DL.3	Axon	DL.2	Early Axon
0	76	55	76	55	56	35	56	35
1	121	100	121	100	94	73	94	73
2	166	145	166	145	132	111	132	111
3	211	190	211	190	170	149	170	149
4	256	235	256	235	208	187	208	
5	301	280			246	225		
6	346	325			284	263		
7	391	370			322	301		
8	436	415			360	339		
9	481	460			398	377		

Select the protocol level in the fixture's onboard menu system for DL.3 and DL.2 fixtures or through the CMA for either Digital Light fixture and Axon media servers (see *Viewing Server Configuration* on page 272).

For a table of the channels included in each level of Version protocol for DL.3 or DL.2 Digital Lights see *DL.3 and DL.2 Version 2 DMX Channel Assignment* on page 311. For a table of channels for Axon media servers running Version 2 protocol, see *Axon Media Server Version 2 DMX Channel Assignment* on page 314.

Lighting Console Tips

Lighting consoles differ in many aspects and it is important to understand how your console operates with DL.3, DL.2 and Axon media servers.

Fixture Libraries

Many sophisticated lighting consoles utilize pre-made fixture libraries. A fixture library consists of profiles for various types of lighting fixtures and devices. Each profile corresponds to the fixture's DMX protocol and allows for ease of programming. Depending upon the manufacturer of your lighting console, some parameters might have different labels for parameter names and functions than are listed within this manual. Consult your lighting console manual for further information.

NOTE: *Downloading the Wholehog Wheelset preferences for DL.2 and DL.3 fixtures will provide a more intuitive order to encoder layout on the console.*
(see <http://www.flyingpig.com/support/hog3/downloads/library/index.shtml>)

Patching Digital Light Fixtures and Axon Media Servers

Digital Lighting servers are patched as multiple "fixture types" in the Wholehog library systems. This allows for ease of programming as well as the ability to adjust quickly for any of the various DMX protocol options. The Motion fixture type controls the actual moving yoke, projector, and integrated camera in DL.2 and DL.3 fixtures. The Global fixture type controls the global graphic engine functions such as intensity, keystone correction, viewpoint, etc. The Graphic fixture type controls each graphic object functions such as opacity, object, media.

An Axon media server has no motion control but utilizes the same Global and Graphic fixture types. In the *Fixture Schedule* or *Add Fixtures* window of Wholehog software, you would add 1 motion, 1 global, and 9 graphic "fixtures" for each complete DL.3 (4 graphic "fixtures" for each DL.2), or 1 global, and 9 graphic "fixtures" for each complete Axon (4 graphic "fixtures" for an original Axon).

The best way to organize your patching is to assign user numbers for these items. Patch the motion first, the global second, and the graphic fixture types last. For example, set up user numbers that correspond to the DL.3 fixture number 1, where user number 1 = motion, user number 2 = global, and user number 3–11 = graphic fixture types.

DMX Output Displays

Although all lighting consoles output the same 512 DMX channels per universe, the on-screen labeling often differs. Parameter functions are displayed in either alpha-numeric descriptions (strobe 1), percentage (0-100%) or decimal (0-255 for 8-bit and 0-65535 for 16-bit). Consult your lighting console manual for further information.

Wholehog Programming Notes

Play Speed

You can adjust the Play Speed using the encoder wheel on the Beam parameter of the Graphic fixture type. Additionally you can press **Enable** and select **Media Speed Default On** to revert to the default speed setting with a DMX value = 128 (50%). Then if you touch the encoder again the previous play speed will be recalled.

Mask Strobe

A unique function of the Wholehog library system allows the creation of a special encoder type. Flying Pig Systems has created a parameter called “mask strobe” in the Global fixture type. When this is adjusted, it will automatically change the DMX value of the mask select channel to the appropriate value and adjust the DMX channel for the strobe speed. This will override the Mask Edge parameter defined in the DL.3 or DL.2 DMX Protocol.

Play Modes (Opacity)

Using the Graphic fixture type, press the Mode button to view the play mode options. By default all modes trigger normally. You can select “Media Trigger Opacity” to change to the Play Modes that trigger when Opacity is greater than zero. To restore to normal triggering, select “Media Trigger Normal”.

CMY

The Global and Graphic fixture types both contain CMY controls for the Effect Mode modifier channels. The default for Effect Mode 1 is set to CMY1 as well. For some effect options, the CMY parameters will not adjust color, but will adjust the effect per the DL.3 or DL.2 DMX protocol. You can find a description of CMY controls functionality for each effect option in *Chapter 13: Effect Mode Options Descriptions* on page 143.

Control Channel Functions

Many of the control channel functions in the motion “fixture” only operate if the dimmer changes from >0 to 0 at the same time or just after a change is made to the control channel. For more detailed description, see *Control Channel Functions* on page 42.

Quick Start with a Wholehog Console

After setting up and configuring your media server as outlined in Chapter 2, use the following steps to get to the point of displaying output. In this example, we are patching a DL.3 fixture running Version 2 software with six Graphic Objects enabled and Axon servers running Version 2 software with five graphic objects enabled.

Step 1: In the *Fixture Schedule* or *Add Fixtures* window of Wholehog software, Add 1 motion, 1 global, and 6 graphic “fixtures” for the DL.3 unit; and 1 global, and 5 graphic “fixtures” for each Axon unit.

Step 2: Assign user numbers for these items. Set up user numbers 1-8 that correspond to DL.3 fixture number 1, where user number 1 is the motion, 2 is the global, and 3-8 are graphic fixture types. Axon media servers will have user numbers 11–16 where user number 11 is global and 12-16 are graphic fixture types.

Patch the motion first, the global second, and the graphic fixture types last for the DL.3 then patch the global and graphic fixture types for the Axon.

Chapter 5:

Tutorials

Five simple lessons get you started programming DL.3, DL.2, and Axon media servers with a Wholehog or other DMX console.

A DL.3, DL.3F or DL.2 fixture should be patched on your console as multiple fixture types depending on how many graphic object layers you plan to use. The MOTION fixture type controls the actual moving yoke, projector, and the onboard camera if present. The GLOBAL fixture type controls the global graphic engine functions such as intensity, keystone correction, viewpoint, etc. The GRAPHIC fixture type controls each graphic object's functions. DL.3, DL.3F, DL.2 and Axon protocol allows for 0–9 graphic objects.

Following this method, a DL.3 should be patched as 1 MOTION fixture, 1 GLOBAL fixture and 1–9 GRAPHIC fixtures. Axon Media servers are patched as 1 GLOBAL and 1-9 GRAPHIC fixtures.

NOTE: *The MOTION fixture Dimmer, GLOBAL fixture Intensity, and GRAPHIC fixture Opacity parameters all have to be greater than zero before the image you create becomes visible.*

In the first three Lessons, the 3-D object component of the Graphic Objects is left at the default DMX value of 1 (flat plane). Note that all DMX values given in the examples are in decimal units.

NOTE: *If you have trouble producing the effects in these tutorials, and you are not working with a Wholehog console library, the default settings may be incorrect.*

Fixture Set-up (DL.3 and DL.2 Fixtures)

If you are using a DL.3 or DL.2 fixture, you will first need to set up the head and the projector. If you are using the Axon Media Server, this will not be necessary and you can proceed to Lesson 1. To set up a DL.3 or DL.2 fixture for the tutorials:

1. Select the fixture's MOTION fixture, and set the **Dimmer** parameter to 100% (DMX = 255). This will open the mechanical iris.
2. Set the GLOBAL fixture **Intensity** parameter and GRAPHIC OBJECT 1 fixture **Opacity** parameter to 100% (DMX = 255).
3. Select the GRAPHIC OBJECT 1 and set the **Media Folder** to DMX = 39 (*HES Setup and Test*). Dial the **Media File** to DMX = 5. This will bring up the convergence bitmap.
4. Select the fixture's MOTION fixture and adjust **Pan** and **Tilt** parameters until the fixture is projecting to the desired location and adjust the **Focus** parameter until the convergence bitmap becomes sharply focused.
5. Now you can remove or "knockout" the GRAPHIC OBJECT from the programmer and still retain the MOTION and GLOBAL parameter settings.
6. Store these values somewhere on your console (to a palette or preset) so that this setup can be quickly recalled whenever you need to adjust the Pan, Tilt and Focus.

Lesson I: Cross Fading Between Graphic Objects

1. On your lighting console, set MOTION fixture Dimmer parameter (for DL.3 or DL.2 fixtures), the GLOBAL fixture **Intensity** parameter, and GRAPHIC OBJECT 1 fixture **Opacity** parameter to 100% (DMX value = 255).

Define Graphic Object 1

2. Set the **Media Folder** Parameter for the GRAPHIC OBJECT 1 fixture to DMX value = 4. This selects preloaded media folder *HES Atmospheric*.
3. Set the **Media File** Parameter to DMX = 23. This selects a water movie (*23-Moonlite_Waves*).



Graphic Object 1

Add the DL.3 logo as Graphic Object 2

4. Select GRAPHIC OBJECT 2 fixture and change the **Opacity** parameter to 100% (DMX = 255).
5. Set the **Media Folder** parameter to 1 and set the **Media File** parameter to DMX = 01. This selects the preloaded fixture logo as content.



Graphic Object 2

Define Graphic Object 3

6. Select GRAPHIC OBJECT 3 fixture and set the **Opacity** to DMX = 255 (100%).
7. Change the **Media Folder** parameter to DMX = 7 (*A Luna Blue* collection).
8. Change the **Media File** parameter to DMX = 2 (*2-Blurs_Streaks_34*).

Create Crossfade Cues

9. Select GRAPHIC OBJECT 2 and 3 fixtures and set the **Opacity** parameter on both to DMX = 0. The only content that is now showing is GRAPHIC OBJECT 1.
10. Record this look to your console as cue 1.
11. Set the of GRAPHIC OBJECT 3 **Opacity** parameter to DMX = 255 (100%) and record this into your lighting console as cue 2.
12. Now set the **Opacity** parameter of GRAPHIC OBJECT 3 to DMX = 0 and the **Opacity** of GRAPHIC OBJECT 2 to DMX = 255 (100%). Record this as cue 3.
13. Now clear out all information in your console's programmer and play through the cues you just recorded. You will see GRAPHIC OBJECT 1 crossfade to GRAPHIC OBJECT 3 and then crossfade to GRAPHIC OBJECT 2.

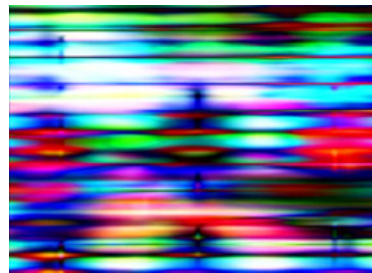

Graphic Object 3

Lesson 2 - Working with Multiple Graphic Objects

In this lesson, you will combine 2 Graphic Objects and use Transparent Color Effect options to create transparencies. You will be building off of cue 3 that was created in Lesson 1.

1. Be sure that the MOTION **Dimmer** parameter (for DL.3 or DL.2 fixtures), the GLOBAL **Intensity** parameter, and GRAPHIC OBJECT 1 and 2 **Opacity** parameters are all set to 100% (DMX = 255).

Apply Transparency Effects

2. With the GRAPHIC OBJECT 2 selected, open the **Effect Mode 1** parameter.
3. Select the *Transparent Color Medium* option (DMX = 27). The DL.3 logo “floats” on a water background.
4. Select *Invert Chroma Fine* option (DMX value = 29). Now the Graphic Object 1 content shows through the logo.
5. Record this look to your console.



Lesson 3 - Girt, the Fire Breathing Lizard

In this lesson you will use Rotation, X, Y, and Z positioning, and scaling parameters to control the interaction of multiple Graphic Objects. Before you begin, clear any information out of your programmer. Also, release playback of cues used in Lessons 1 and 2. You may want to start a new cuelist for this exercise. If you are using a DL.3 or DL.2 fixture, be sure that you have set up the fixture's motion parameters as described in the beginning of this tutorial.

1. Be sure that the MOTION **Dimmer** parameter (for DL.3 or DL.2 fixtures), the GLOBAL **Intensity** parameter, and GRAPHIC OBJECT 1 **Opacity** parameter are all set to 100% (DMX = 255).

Define Graphic Object 1

2. Set the **Media Folder** parameter for GRAPHIC OBJECT 1 to DMX = 14 (HES Theme Stills).
3. Set the **Media File** parameter to a DMX value = 10. (10-Tropical_10.jpg).



Define Graphic Object 2

The following steps select and position a flame graphic object.

4. Select the GRAPHIC OBJECT 2 and set the **Opacity** parameter to DMX = 255 (100%).
5. Set the **Media Folder** parameter to DMX = 4 (HES Atmospheric).
6. Set the **Media file** parameter to DMX = 16 (16-Fire_Triple_Burst).
7. Set **Effect Mode 1** parameter for GRAPHIC OBJECT 2 to DMX = 28 to select the *Transparent Color Coarse* effect. This will make the black background transparent.
8. Reduce the Y Scale parameter to -5.7x (DMX = 55).
9. Reduce the X Scale parameter to -2x (DMX = 102).
10. Set the X Position parameter to a real world value of 37 pixels (DMX = 33530).
11. Set the Y Position parameter to a real world value of 13 pixels (DMX = 33042).
12. Set the Z Rotation parameter to a real world value of -25° (DMX = 33042).



Define Graphic Object 3

The following steps create and position a puff of smoke.

13. Select the GRAPHIC OBJECT 3 and set the **Opacity** parameter to DMX = 255 (100%).
14. Set the **Media Folder** parameter to DMX = 4 (HES Atmospheric).
15. Set the **Media File** parameter to a DMX value of 17 (17-Dust_Explosion).



16. Set **Effect Mode 1** parameter for GRAPHIC OBJECT 3 to DMX = 28 to select the *Transparent Color Coarse* effect. This will make the black background transparent.
17. Set the **X Scale** parameter to a real world value of -7.4x. (DMX = 33)
18. Set the **Y Scale** parameter to a real world value of -6.4x. (DMX = 46)
19. Set the **X Position** parameter to a value of 20 pixels. (DMX = 33177)
20. Set the **Y Position** parameter to a value of 8 pixels. (DMX = 33932)
21. Record this look into your lighting console.

Lesson 4: 3-D Objects, Rotation, Wobulation, and Glow.

In this lesson you will learn how to put your chosen content on a 3D object and add rotation, glow, and wobulation.

1. Be sure that the **MOTION Dimmer** parameter (for DL.3 or DL.2 fixtures), the **GLOBAL Intensity** parameter, and **GRAPHIC OBJECT 1 Opacity** parameter are all set to 100% (DMX = 255).

Define Graphic Object 1

2. With **GRAPHIC OBJECT 1** selected, set the **Media Folder** parameter to DMX = 1 (HES Core).
3. Set the **Media File** parameter to DMX = 3. This will call up a black.jpg.
4. Change the **Object** parameter to DMX = 23 (Outside Cube).
5. Set the **Effect Mode 1** to DMX = 73 (Glow)
6. Set the **Effect 1 Modifier 1** parameter to 93% (DMX = 236)
7. Set the **Effect 1 Modifier 2** parameter to 25% (DMX = 63).

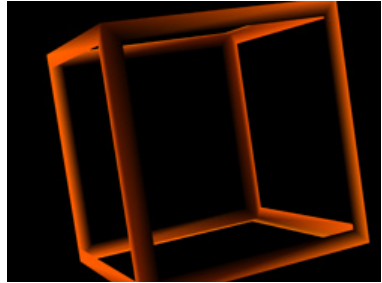

NOTE: *Modifier channels for Effect Mode 1 are labeled as CMY in the Wholehog system so you can also make use of the color picker, HSI, and other Wholehog functions. Use the CMY parameter controls to adjust the three Effect Mode 1 Modifier parameters for both the Global and Graphic fixture types.*

8. Change the **X Rotation** parameter to 5°. (DMX = 32887)
9. Change the **Y Rotation** parameter to a real world value of -32°. (DMX = 32033)

Define Graphic Object 2

10. Select **GRAPHIC OBJECT 2** and set the **Opacity** parameter to DMX = 255 (100%).
11. Change the **Media Folder** parameter to DMX = 6 (*Sean Bridwell*)
12. Change the **Media File** parameter to DMX = 16 (*Fractal_Flower*).
13. Change the **Object** parameter to DMX = 9 (*moiré swirl*)

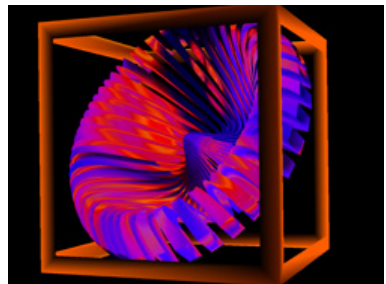

14. Change the **X Rotation** parameter to 28°
(DMX = 33405)
15. Change the **Y Rotation** parameter to 36°
(DMX = 33577)
16. Open the **Effect Mode 1** parameter and set DMX = 66
(*Circular Sinewave Z-axis Wobulation*).

Adjust this effect with the Modifier parameters.

17. Set the Effect Mode 1 Modifier 1 parameter to DMX = 104 (41%) to adjust wave size.
18. Set the Effect Mode 1 Modifier 2 parameter to DMX = 86 (34%) to adjust wobulation rate.
19. Set the Effect Mode 1 Modifier 3 parameter to DMX = 114 (45%) to adjust offset.

NOTE: *Modifier parameters make different adjustments depending on the effect you choose.*

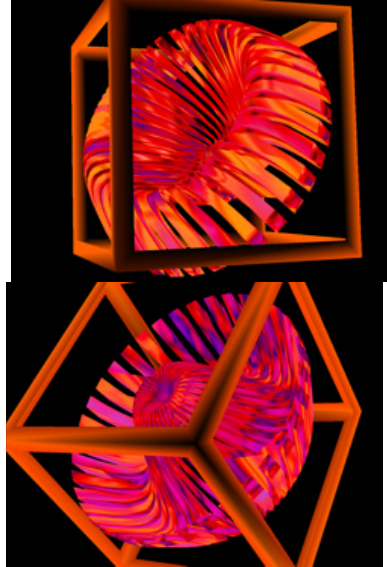

Lesson 5: Viewpoint

This lesson demonstrates the global parameters including viewpoint, and global effects.

1. Be sure that the MOTION **Dimmer** parameter, (for DL.3 or DL.2 fixtures) the GLOBAL **Intensity** parameter, and GRAPHIC OBJECT 1 **Opacity** parameter are all set to 100% (DMX = 255).

Define Graphic Object 1

2. With GRAPHIC OBJECT 1 selected, change the **Media Folder** parameter to *feedback video* (DMX = 8).
3. Change the **Media File** parameter to DMX = 7 (*7-SD_Cloud010*)
4. Change the **Object** parameter to DMX = 21 (*triangle*)
5. Set the **Z Position** parameter to 118 pixels (DMX = 35187), the **Y Position** parameter to 30 pixels (DMX = 33372), and the **X Position** parameter to -43 pixels (DMX = 31888).

Define Graphic Object 2

6. Select GRAPHIC OBJECT 2 and bring the **Intensity** parameter to 100% (DMX = 255).
7. Change the **Media Folder** parameter to DMX = 8 (*feedback video*).
8. Change the **Media File** parameter to DMX = 9 (*9-SD_Deep01*)
9. Change the **Object** parameter to DMX = 8 (*toroid chk board*)
10. Change the **Z Position** parameter to a value of 64 pixels (DMX = 34087)

Define Graphic Object 3

11. Select the GRAPHIC OBJECT 3 and change the **Intensity** parameter to 100% (DMX = 255).
12. Set the **Media Folder** parameter to DMX = 8 (*feedback video*)
13. Set the **Media File** parameter to DMX = 8 (*8-S_Dash*)
14. Change the **Object** parameter to DMX = 44 (*star bevel 4*)
15. Set the **Z Position** parameter to 40 pixels (DMX = 33592), the **Y Position** parameter to -13 pixels (DMX = 32493), and the **X Position** parameter to 30 pixels (DMX = 33372).



Apply a Global Solarize Effect

16. Select your GLOBAL fixture and change the **Effect Mode 1** parameter to DMX = 10 (*solarize 2*) and observe how the global effect changes all three of the graphic objects at one time
17. Record this look into your console.

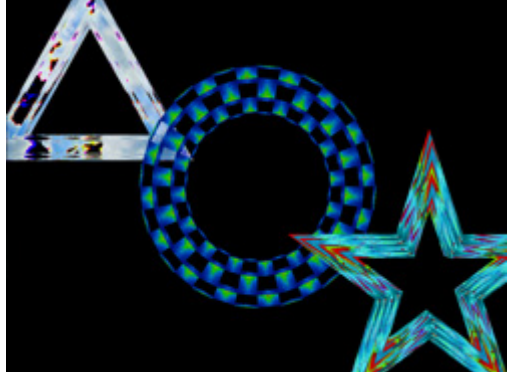

Adjust Global Viewpoint Mode

18. To select the *Perspective View with Spherical Coordinates* centered on Graphic Object 2, set the **Global Viewpoint Mode** parameter to *sphr lyr 2* (DMX = 2).
19. Change the **Viewpoint Position X** parameter to 316° and see how this changes the viewpoint position of all three graphic objects at one time.
20. Change the value of the **Viewpoint Mode** parameter to *ortho lyr 2* (DMX = 10) for an Orthogonal View using Cartesian Coordinates.
21. Set **Viewpoint Position X** parameter to 39° (DMX = 36337)
22. Set **Viewpoint Position Y** parameter to 101° (DMX = 41947)
23. Set **Viewpoint Position Z** parameter to 116° (DMX = 43354).
24. Record this into your console and play back the cues you have created to observe how viewpoint changes the perspective on the graphic objects.

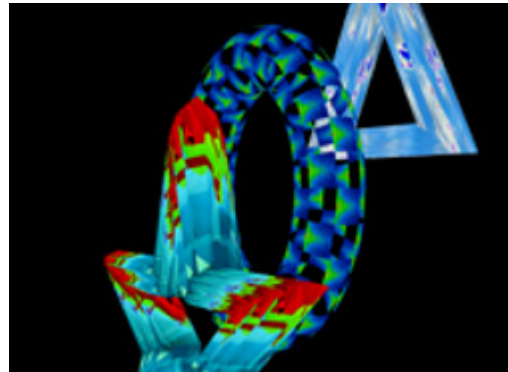

Chapter 6:

Graphics Engine Overview

DL.3, DL.2, and Axon Media servers all use the same graphic engine software to control content selection, playback, and 3-D Object and Global manipulation.

Protocol Options

You can use one of two Protocol Versions to control DL.3 and DL.2 fixtures, and Axon media servers. Both versions provides individual and composite control for multiple graphic objects.

Version 1 maintains the original channel range for DL.3, DL.2 fixtures or Axon media servers and offers compatibility with legacy shows.

Version 2 adds an additional 27 channels of control with:

- Five banks of Global Effects instead of three in Version 1
- Eight channels of Global Framing Shutters
- Expanded Collage adjustments with 16-bit control of X, Y and Z scaling
- Global spherical mapping control
- An additional bank of Graphic Effects

Both Protocol versions include multiple new effects and can control up to nine Graphic Objects layers on DL.3 fixtures and Axon media servers.

NOTE: *DL.2 fixtures and the early Axon units are limited to four Graphic Object layers of control.*

You can adjust the “footprint” of the fixture on a DMX link with the protocol you choose and by implementing only the number of 3-D objects you need.

You select the protocol level in the fixture's onboard menu system for DL.3 and DL.2 fixtures or through the CMA for both fixtures and Axon media servers (see *Viewing Server Configuration* on page 272).

Appendix A: DMX Protocol on page 311 has a detailed listing of all the parameters for all media servers and they are discussed in more detail in the following chapters.

#of Object Layers	V2 Footprint on DMX512 Link				V1 Footprint on DMX512 Link			
	DL.3	Axon	DL.2	Early Axon	DL.3	Axon	DL.2	Early Axon
0	76	55	76	55	56	35	56	35
1	121	100	121	100	94	73	94	73
2	166	145	166	145	132	111	132	111
3	211	190	211	190	170	149	170	149
4	256	235	256	235	208	187	208	
5	301	280			246	225		
6	346	325			284	263		
7	391	370			322	301		
8	436	415			360	339		
9	481	460			398	377		

Image Optimizing Controls

Images can now be optimized for each cue. It is no longer necessary to pre-optimize images with a separate software system on a separate computer when preparing for a show. Using Visual modes, you can adjust both Black Level and Contrast for each cue and for each image (see *Visual Mode Options* on page 82).

Graphics Control Hierarchy

There is a hierarchy to the DMX control parameters. In general, object control parameters render individual graphic images. Global control parameters act upon the composite image created by combining multiple objects. Motion parameters control the fixture movement and projection as well as live video feed from the internal camera.

It is especially important to keep this in mind when applying graphical effects. At the lowest level, Graphic effects are applied to an individual 3-D Graphic Object. Any Global effects applied affect each object in the combined Object image. Finally, motion effects control the projection of the composite image.

Graphics Engine Function Flow

*Define up to nine
3-D objects with
a texture applied*

*Graphic
Functions
are applied
to each object*

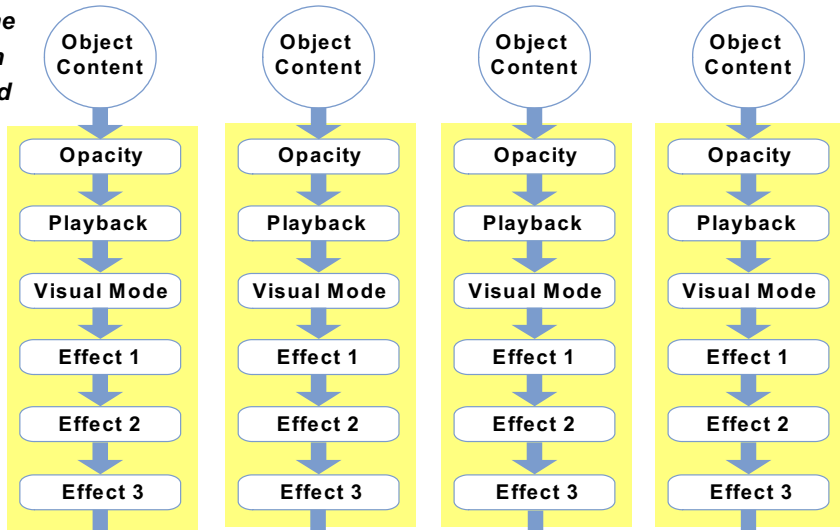

*Global Functions
are then applied to the
composite-object image.*



*Graphics Engine outputs
final image to projector*

Graphics Engine Functions

Object Graphic Functions

For an individual object, you can control:

- The media file and 3-D object selection for the layer
- Media playback including
 - What portion of the movie plays
 - Playback speed
 - Playback mode (direction and style of playback)
- The object transparency (opacity)
- Visual Effects including colormixing and geometric effects
- Synchronization
- Image Rotation, Scale and Position

Global Functions

Global controls are applied to composite image created by multiple 3-D images. For the combined image, you can:

- Adjust the composite image intensity level
- Apply visual effects including colormixing and geometric effects
- Select a mask shape, size it and apply edge fades and color to the mask
- Apply and color mix an image edge fade
- Control keystone correction
- Create Framing Shutters
- Establish the point in 3-D space from which image will be viewed

Making Graphics Effect Choices

Because you have control of many parameters, there are sometimes several ways to accomplish the same look. For Example, to make an object appear larger, you can scale it along the x, y and z axis, or you can apply a global control to zoom in on the z axis from a viewpoint that makes the object seem to increase in size.

Which solution you choose depends, to a large extent, on the transition to other effects you want to achieve.

Chapter 7:

Graphic Functions: Defining Content

Each Graphic Object's content is composed of a 3-D object overlaid with a media file. This chapter outlines how to select an image's object and media file components as well as define the video segment and its playback.

Content Overview

In addition to a royalty-free stock digital art collection featuring more than 1,500 lighting-optimized files available as stock content, you can develop your own custom media files and 3D object files for playback on DL.3, DL.2 or Axon media servers. For a quick overview on developing your own custom User content, see *Appendix C: Custom User Content* on page 347. The Digital Lighting Product and Support pages at highend.com/digital_lighting offer additional assistance and the latest software and techniques for creating and encoding custom content.

Every DL.3, DL.2 and Axon media server has a file system that holds the movies, images, and 3-D objects that make up the content that the server uses. These files, folders, and their associated DMX values are collectively known as the "Content" on the media server.

The Content Management Application (CMA) organizes and identifies content by source (preloaded Stock content or custom User content) and type (Media files or 3-D Object files). For more information on using the CMA to view and manage content, (see *Chapter 16: Content Management Application (CMA)* on page 245).



Selecting Content

Three Parameters control content selection. To define an image you have to set DMX values greater than 0 for the 3-D Object, Media Folder, and Media File parameters. The selected media file will be mapped onto the selected 3-D object.

To output an image from a media server:

1. Open the mechanical iris on the projector by setting its Dimmer parameter to full (100%).
2. Set the Global Intensity parameter to full (100%).
3. Set the Object opacity to full (100%)
4. Adjust the Object, Media Folder, and Media File parameters to greater than zero

When programming with Wholehog software, the Media Folder and Object parameters default to 1 so choosing any Media File DMX value from 1-35 will display a media loop from the HES Core folder (Media Folder 1) wrapped on a Flat Plane (Object 1).

NOTE: *The Dimmer, Opacity and Global Intensity Parameters all have to be greater than zero before the image you create becomes visible.*

Content Selection Parameters

The following sections outline parameters you will use to create an image from content and define its playback. You will set the parameters described in this chapter for **each** individual Graphic Object you define.

NOTE: *The suggested default DMX values given for each parameter are recommended to build libraries that provide the easiest and most reliable content selection, rendering and output. They are the default values built into the Wholehog libraries for High End Systems consoles.*

Object

The **Object** parameter selects the 3-dimensional object component of an image. Object files are the 3-D object shapes used to build a total image. The graphics engine supports a combined total of 255 stock and user-created object files.

Stock Objects have a fixed DMX value and cannot be edited. DMX values 1-149 are reserved for identifying stock object files. User-created object files must be assigned a unique DMX value from 150-255.

For a reference of 3-D object files available as stock content with your media server and information on how to create your own object files, go to the link for the Stock Object Guide for the DL.3, DL.2 and Axon products on http://www.highend.com/support/digital_lighting/.

Default DMX Value: 1 = full screen flat surface

TIP: *You can select the same object file for images that will be interacting with each other. If both objects occupy exactly the same area in 3-D space, “Z-fighting” (a shimmering effect) on some portions of the composite image can occur as the graphics engine tries to determine which object should be in the foreground.*

You can avoid this effect by making a slight adjustment to one of the object’s scale or moving it forward or back (using the Z Position parameter) in respect to the other.

Media Folder

This parameter defines a folder (directory) containing a collection of media files. The media files within the assigned folder can then be selected using the **Media File** parameter. DMX values for folders are assigned as follows:

- DMX values = 1-39 are used or reserved for Stock Content
- DMX values = 40-240 are reserved for User Content
- DMX value = 255 is reserved for live video input

Default DMX Value = 1 (HES Core Media files)

The following table describes the Stock Content folders available on DL.3, DL.2 and Axon servers.

NOTE: *Media folders with DMX Values of 27-35 are only available as stock content on DL.3 fixtures and Axon Version 2 servers.*

Media Folder Descriptions.

DMX Value	Media Folder Name	Content Description
1	HES Core	Premier High End Systems video loop collection
2	HES_Digital_Aerials_1	Digital still images and animations, designed for aerial effects
3	HES_Oils	Digitally simulated psychedelic oil projection loops
4	HES_Atmospheric	Video loops of natural settings clouds, water, fire
5	On_The_Wall_Studios	Digital video loops, promotional
6	Sean_Bridwell	Digital video loops, promotional
7	A_Luna_Blue	Digital video loops, promotional
8	Feedback_Video	Digital video loops, promotional
9	HES_Texture	Video loop textures
10	HES_Foliage	Collection of abstract and realistic foliage and floral video loops
11	HES_Religious	Religious themed video loops
12	HES_Gothic	Set of themed video loops
13	HES_Digital_Aerials_2	Digital still images and animations, designed for aerial effects
14	HES_Theme_Stills	Nature stills (foliage and flowers)
15	Apollo Glass	Digital Gobo Patterns, promotional
16	Artbeats	Digital video loops, promotional
17	DHA_TopMac	Digital patterns, promotional
18	Beacon DigiGobos	Digital video loops, promotional
19	Amorphous Digi-gobos	Digital animations, promotional
20	InLight	Digital video loops, promotional
21	HES_Lithopatterns_1	High End Systems Lithopattern® images
22	HES_Lithopatterns_2	More images from High End Systems Lithopattern library
23	HES_Logos	High End Systems® Axon and DL.2™ logos
24	HES_Hi_Res	Variety of high resolution video backgrounds
25	NASA_Images	Space images from the Hubble telescope
26	Blue_Pony	Assorted video loops
27	HES_Core_02	Mixed footage
28	V-Squared-Labs	Club themed footage
29	Virtual-Life-Media	Club themed footage and few stills
30	Daddy-Van-Productions	Digital backgrounds
31	Wet-Digital	Underwater footage
32	Idyll-Hands-Imagery	Aerial footage
33	David-Alley-Photography	Nature themed high resolution images
34	JTM-Photography	Nature stills
35-38	Reserved	Reserved for HES use
39	HES_Setup_and_Test	Images to use for setup and diagnostics
40-240	Open	Available for User Content
255	Video Input	Live video input from internal camera or external device

Media File

The **Media File** parameter lets you identify which Stock or User media file to apply (map) as a texture on the selected 3-D object. You can supplement the large library of Stock video loops and still images with Custom files. This parameter selects media files from within the folder defined by the **Media Folder** parameter.

For a reference of media files available as stock content with your media server, go to the link for the Stock Content Guide for DL.3, DL.2 and Axon products on http://www.highend.com/support/digital_lighting/.

Default DMX Value: 0 = No file selected

***Tip:** You can preview a visual display of the media files loaded on a media server in the Content Management Application's thumbnails view, (see Viewing Content on page 253) or in the File Tab of a DL.3 or DL.2 fixture menu display.*

Defining a Media File Segment

You can define any portion of a video media file to play using the **In Frame** and **Out Frame** parameters. By default, the In Frame is the beginning of the media file and the Out Frame is the end of the file. Media files can have different lengths.

***NOTE:** Media that is not properly encoded may still play, but may have issues when using In-Frame and Out-Frame parameters.*

In Frame and Out Frame Parameters

You can select any segment of a media file for playback by assigning an In Frame value as a start point and an Out Frame as an end point.

***NOTE:** DMX parameter values for these parameters do not correspond to a particular "frame". They are defined as a percentage of the movie length. This makes it possible to create segments with an Out Frame preceding the In Frame and simplifies playback synchronization between media files.*

The **In Frame** parameter corresponds to a 16-bit DMX value equal to a starting point for the playback segment of the selected file. The **Out Frame** parameter corresponds to a 16-bit DMX value equal to an end point for the playback segment of the selected media file.

Assigning the In Frame and Out Frame parameters to default DMX values will playback the entire movie file.

Choosing other settings are useful when you want to:

- Begin or end a media file at any point other than the default
- Start or stop on a specific image
- You need to shorten the media file to a specific length

In Frame Default DMX Value: 0 = The beginning of a media file is the playback start point.

Out Frame Default DMX Value: 65535 = The end of a media file is the playback endpoint.

As you move from 0 to 100% of the **In Frame** value range, you can select the beginning of a media file segment as a percentage of the file length. Moving from 0 to 100% of the **Out Frame** value range selects the end of a media file segment as a percentage of the file length.

Segment Selection Examples

You can create a segment anywhere between the beginning and the end of a media file.

The In Frame does not have to precede the Out Frame.

To skip a segment in the center of a media file, set the In Frame to a point following the Out Frame. The file will play from the In Frame to the end and then start at the beginning of the file and play to the Out Frame. When you create a segment in this way, you may notice a jump as playback skips from the end of the file to the beginning.

Example 1



Example 2

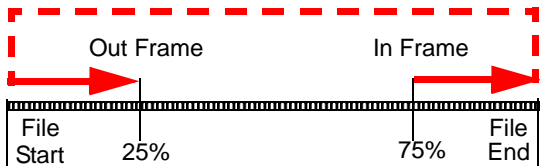

Defining Playback

After selecting and defining a media file segment to display on a 3-D object, you can choose from several **Playback Modes** and assign a **Playback Speed**.

Playback Mode

A **Playback Mode** parameter for each 3-D image allows several playback options.

Default DMX Value: 0 = Plays forward in a continuous loop

DMX Value	Playback Mode	Description
0	Play forward looping	Plays the media segment from In Frame setting to Out Frame setting, looping continuously
1	Play forward once	Plays the media segment from In Frame setting to Out Frame setting, and holds on the last frame
2	Pause	Stops playback at the frame currently playing
3	Play forward once if opacity > 0	Plays the media segment from In Frame setting to Out Frame setting, and holds on the last frame, Plays only when the content opacity value is greater than zero.
4	Play forward if opacity > 0	Plays media segment from In Frame setting to Out Frame setting, looping continuously. Plays only when the content opacity value is greater than zero.
5	Pause and rewind	Stops playback at the frame currently playing, then jumps to the In Frame setting.
6	Scrub In Frame	Displays frame that has been defined by the In Frame parameter
7	Scrub Out Frame	Displays frame that has been defined by the Out Frame parameter
8	Scrub In Frame with statistics	Displays frame that has been defined by the In Frame parameter with media file data overlaid on the output.
9	Scrub Out Frame with statistics	Displays frame that has been defined by the Out Frame parameter with media file data overlaid on the output.

Scrubbing

Scrubbing displays the selected frame of the composite output of the media server. While scrubbing the In Frame, the frame selected by the **In Frame** coarse and fine channels will be displayed. Likewise, scrubbing the **Out Frame** will display the frame selected by the **Out Frame** coarse and fine channels. When the “with statistics” option is selected, the composite output includes text data related to the selected frame. Remember that the **In Frame** and **Out Frame** parameters are defined as a DMX value mapped to the percentage of the media file length, not a specific frame.

NOTE: *If the Global Control Mode parameter = 255, a DMX value of 1-3 for the Global Control parameter provides an alternate font color to enhance statistics readability.*

Playback Speed

The **Playback Speed** parameter controls the speed of the selected media file's Playback Mode. The Playback Speed for a media file is used whenever the Playback Mode Parameter's DMX value is assigned to any Play Forward option.

Default DMX Value: 128 = Playback at normal speed.

A DMX value of 0 or 128 (50%) plays back media files at the original recorded speed. DMX values from 1 to 127 plays the media file back at an increasing speed, from slowest to the original recorded speed. Values from 129-255 set playback speed from faster than normal to fastest speed.

NOTE: *DMX Values 1-127 utilize frame blending to provide a smooth playback motion at slow speeds.*

Chapter 8:

Graphic Functions: Rotation, Position, Scale

You can independently control each Graphic Object's rotation direction and speed; along with its position and scale in X, Y, and Z axis directions.

The parameters described in this chapter are set for each Graphic Object you define. Parameters for composite image rotation, position and global scale are described in *Chapter 11: Global Functions*.

NOTE: *The suggested default DMX values given for each parameter are recommended to build libraries that provide the easiest and most reliable content selection, rendering and output.*

Rotating a 3-D Object

The **Rotation** parameters for each object control 3-D object rotation with 16-bit precision. You can rotate a 3-D object up to 720° in either a clockwise or counterclockwise direction around the X, Y and/or Z axis.

NOTE: *Remember that rotation changes could affect an object's relationship to other objects.*

When you rotate an object, you are rotating it around the selected axis. **X Rotation** produces the effect of a top-to-bottom flip. **Y Rotation** produces a left-to-right flip. **Z Rotation** causes a circular motion.

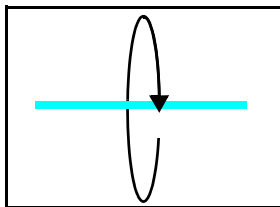

X Rotation

Rotates image about the X axis

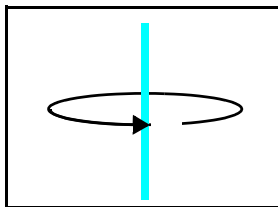

Y Rotation

Rotates image about the Y axis

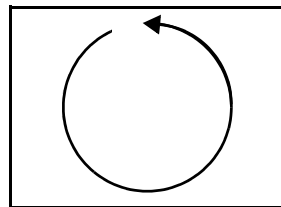

Z Rotation

Rotates image about the Z axis

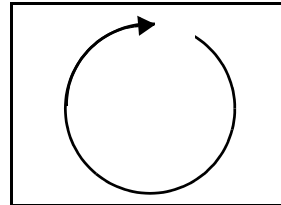
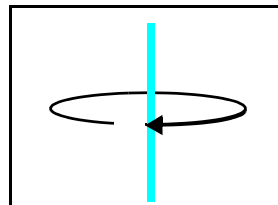
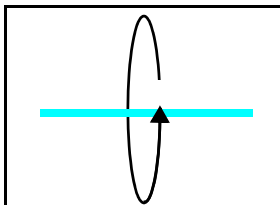

The Rotation parameters' suggested default values are the midpoint of the 16-bit DMX value range, which is equal to no rotation. Increasing the DMX value from the midpoint indexes the object in a clockwise direction. Reducing the DMX value below the midpoint indexes the object in a counterclockwise direction.

When the DMX value for a rotation parameter is greater than the 720° limit in either direction, the object begins rotating continuously. Additional adjustment to the DMX values increases the speed of continuous rotation.

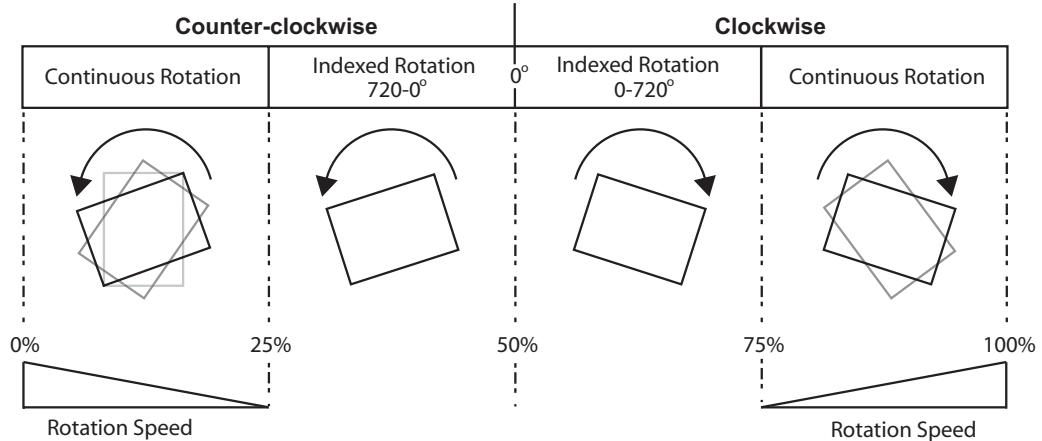

NOTE: *Global and Graphic Effects Mode parameters contain a Prerotation Translation effect option. When a Global or Graphic Effects Mode DMX value = 102, you can use the Effect Modifier parameters to locate the image in a virtual three dimensional space. Applying the Rotation parameters then cause the image to orbit around the selected axis from that location, see Prerotation Translation on page 216.*

Rotation Parameters

X Rotation

The **X Rotation** parameter rotates the selected Graphic Object around the X axis with 16-bit precision. You can index the rotation or set a continuous rotation creating a vertical flip at variable speeds.

This parameter lets you view an object from a different angle by turning the object. You can also view an object from a different angle by changing the viewpoint in space for the composite image, (see *Global Viewpoint Mode* on page 128).

Default DMX Value: 32768 (50%) = No X Rotation

% of Value Range	Function
1–24	Continuous variable-speed counterclockwise image rotation around X-axis (fast to slow)
25	Continuous rotation stop
26–49	Rotates the image counterclockwise around X-axis in steps to -720 degrees
50	0° rotation around X-axis
51–74	Rotates the image clockwise around X-axis in steps to 720 degrees absolute
75	Continuous rotation stop
76–100	Continuous variable-speed clockwise image rotation around X-axis (slow to fast)

Tip: Using this parameter you can turn one object through another.

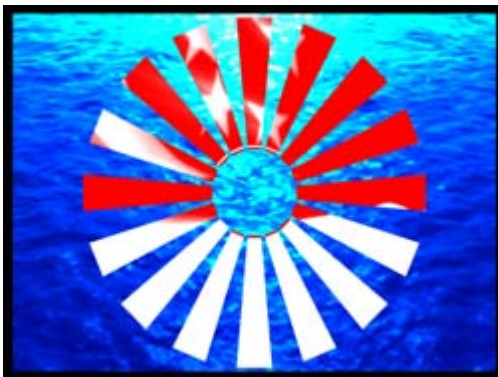

Original Object 1 and Object 2



X-axis Rotation Applied to Object 2

Y Rotation

The **Y Rotation** parameter rotates or indexes the selected Graphic Object around the Y axis with 16-bit precision. You can index the rotation or set a continuous rotation creating a horizontal flip at variable speeds.

This parameter lets you view an object from a different angle by turning the object. You can also view an object from a different angle by changing the viewpoint in space for the composite image, (see *Global Viewpoint Mode* on page 128).

Default DMX Value: 32768 (50%)= No Y Rotation

% of Value Range	Function
1–24	Continuous variable-speed counterclockwise image rotation around Y-axis (fast to slow)
25	Continuous rotation stop
26–49	Rotates the image counterclockwise around Y-axis in steps to –720 degrees
50	0° rotation around Y-axis
51–74	Rotates the image clockwise around Y-axis in steps to 720 degrees absolute
75	Continuous rotation stop
76–100	Continuous variable-speed clockwise image rotation around Y-axis (slow to fast)

Tip: Using this parameter you can turn one object through another

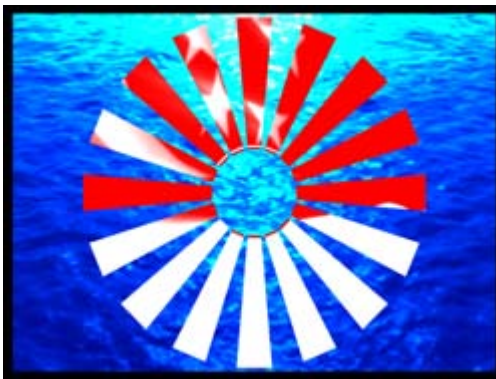

Original Object 1 and Object 2

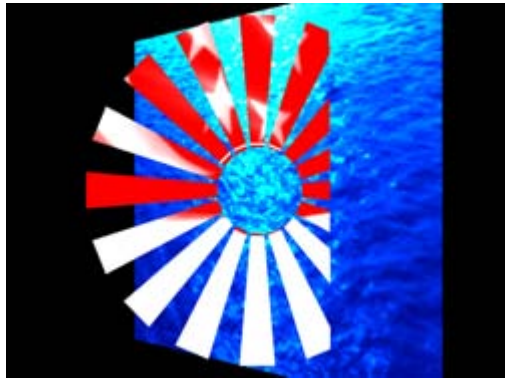

Y-axis rotation applied to Object 2

Z Rotation

The **Z Rotation** parameter rotates or indexes the selected Graphic Object around the Z axis with 16-bit precision. You can index the rotation or set a continuous rotation creating a circular spin at variable speeds.

Default DMX Value: 32768 (50%)= No Z Rotation

% of Value Range	Function
1–24	Continuous variable-speed counterclockwise image rotation around Z-axis (fast to slow)
25	Continuous rotation stop
26–49	Rotates the image counterclockwise around Z-axis in steps to –720 degrees
50	0° rotation around Z-axis
51–74	Rotates the image clockwise around Z-axis in steps to +720 degrees
75	Continuous rotation stop
76–100	Continuous variable-speed clockwise image rotation around Z-axis (slow to fast)

This parameter lets you view an object from a different angle by turning the object. You can also view an object from a different angle by changing the viewpoint in space for the composite image, (see *Global Viewpoint Mode* on page 128).

Tip: Using this parameter you can turn one object around another

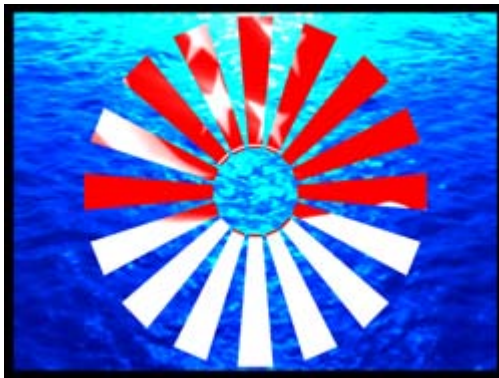

Original Object 1 and Object 2

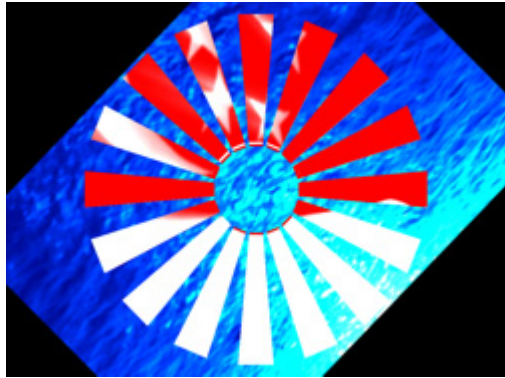

Z-axis Rotation Applied to Object 2

Scaling the Object

You can scale an Graphic Object along the X, Y and/or Z axis to adjust the object size.

The **Scale** parameter adjusts the size of the object's image up to approximately 10x its original size. At a DMX value of zero, the image shrinks to a dot. At the midpoint of the DMX value range, the image is normal size. When the DMX value is increased from the midpoint, the image is enlarged. In addition, when the DMX value is reduced below the midpoint, an inverted image is enlarged.

Tip: Use the **X,Y** and **Z Scale** parameters together to enlarge or shrink a 3-D object proportionally.

X Scale

The **X Scale** parameter uses two channels to scale the selected 3-D object along the X axis, either expanding it or making it smaller. Use it when you want to size the object's horizontal component.

A DMX value of 32768 (50%) sets the object at its normal size. Values less than 50% shrink the object horizontally to the smallest at 0. Values greater then 50% enlarge the object horizontally to the largest at 255 (100%).

Default DMX Value: 32768 (50%) = Normal Scale

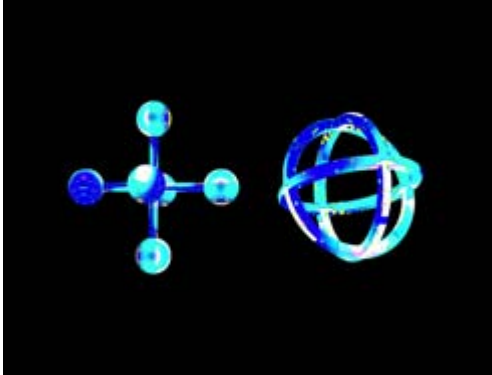

Original Object 1 and Object 2
All Scale DMX values = 32768 (50%)

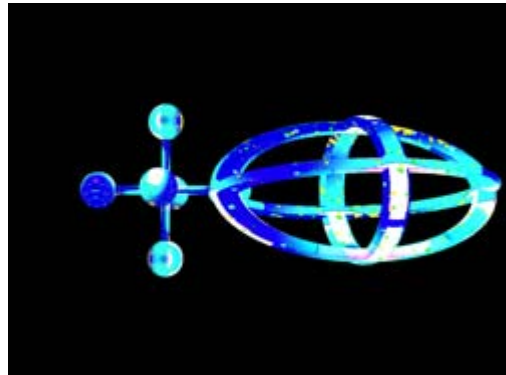

Object 2 X-Scale DMX value = 165
Scaled 3 times in X direction

Y Scale

The **Y Scale** parameter uses two channels to scale the selected 3-D object along the Y axis, either expanding it or making it smaller. Use it when you want to size the object's vertical component.

A DMX value of 32768 (50%) sets the object at its normal size. Values less than 50% shrink the object vertically to the smallest at 0. Values greater than 50% enlarge the object vertically to the largest at 255 (100%).

Default DMX Value: 32768 (50%) = Normal Scale

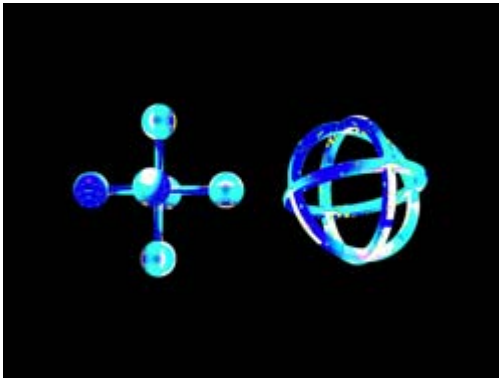

Original Object 1 and Object 2
All Scale DMX values = 32768 (50%)

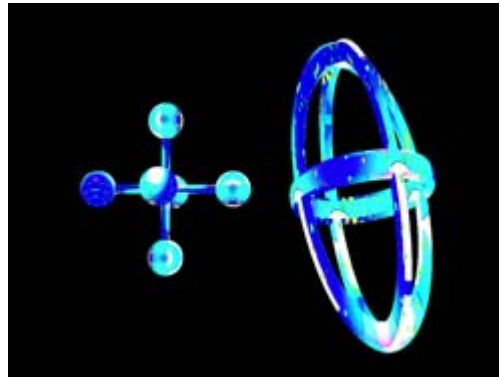

Object 2 Y-Scale parameter DMX value = 165
Scaled 3 times in Y direction

Z Scale

The **Z Scale** parameter uses two channels to scale the selected 3-D object along the Z axis, either expanding or shrinking it. Use it when you want to size the object's thickness.

A DMX value of 32768 (50%) sets the object at its normal size. Values less than 50% shrink the the object thickness until it reaches a point at a value of 0. Values greater then 50% enlarge the object to a maximum thickness at 255 (100%).

Default DMX Value: 32768 (50%) = Normal Scale

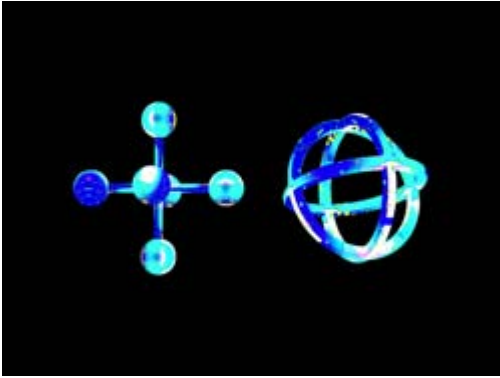

Original Object 1 and Object 2
All Scale DMX values = 32768 (50%)

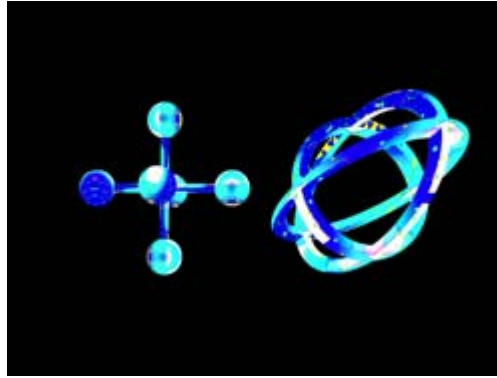

Object 2 Z-Scale parameter DMX value = 223
Scaled 7.5 times in Z direction

Changing Object Position

You can reposition each 3-D object's position in 3-D space by moving it along the X, Y and Z axes. The following parameters act on an individual object. Use these parameters to position 3-D images in relation to each other.

X Position

The **X Position** parameter moves your object along the X axis with 16-bit precision.

The midpoint of the 16-bit DMX value range centers the image on the X-axis. Values below the DMX midpoint move the object left, and values above the DMX midpoint move the object right.

Default DMX Value: 32768 (50%) = object centered in frame

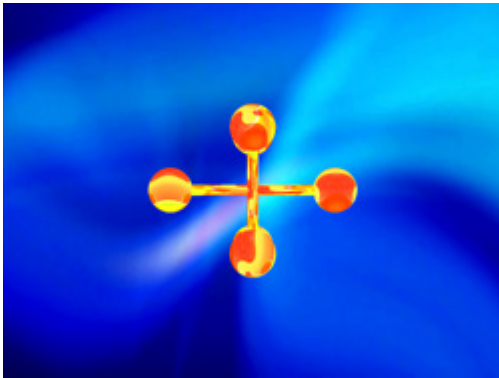

Original Object 1 and Object 2
All Position DMX values = 32768 (50%)

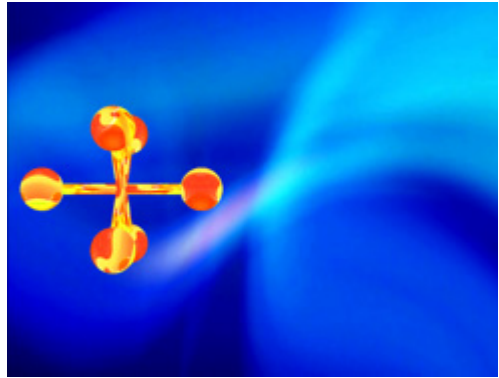

Object 1: X Position DMX value = 32022

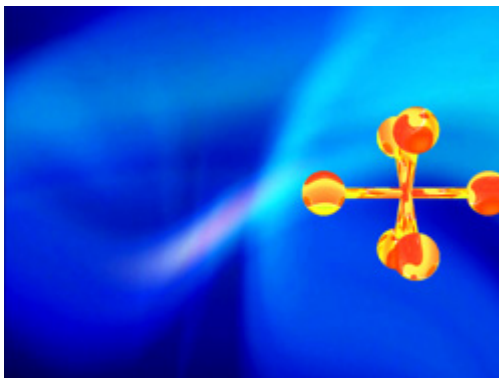

Object 1: X Position DMX value = 33561

Y Position

The **Y Position** parameter moves your object along the Y axis with 16-bit precision.

The midpoint of the 16-bit DMX value range, centers the image on the Y-axis. Values below the DMX midpoint move the object down, and values above the DMX midpoint move the object up.

Default DMX Value: 32768 (50%) = object centered in frame

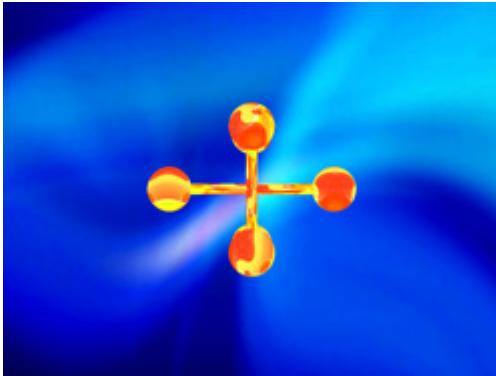

Original Object 1 and Object 2
All Position DMX values = 32768 (50%)

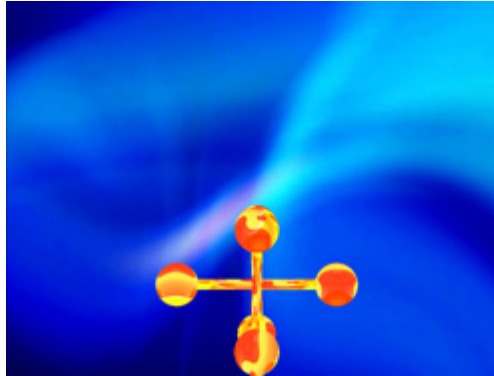

Object 1: Y Position DMX value = 32255

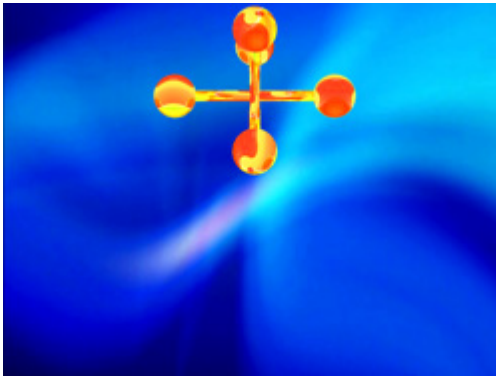

Object 1: Y Position DMX value = 33269

Z Position

The **Z Position** parameter moves your object along the Z axis with 16-bit precision.

The midpoint of the 16-bit DMX value range centers the object on the Z axis. Values below the DMX midpoint move the object away from the viewer and appears to become smaller, and object above the DMX midpoint move the object toward the viewer and appears to become larger.

Default DMX Value: 32768 (50%) = object centered in frame

Tip: This parameter can create a zoom effect. Remember that by moving an object, you can obscure other objects or move it behind your viewpoint where it is no longer visible.

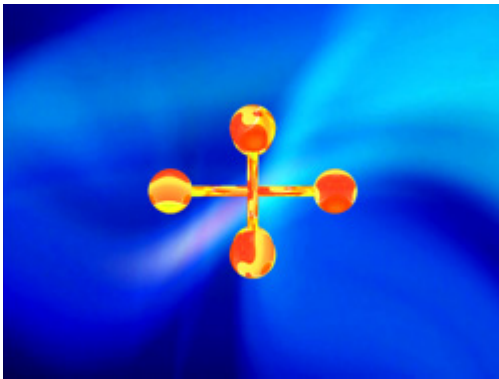

Original Object 1 and Object 2
All Position DMX values = 32768 (50%)

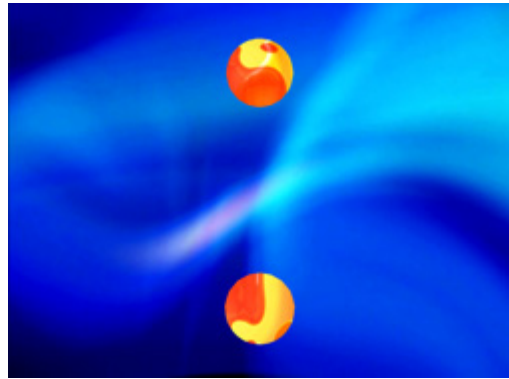

Object 1: Z Position DMX value = 31884

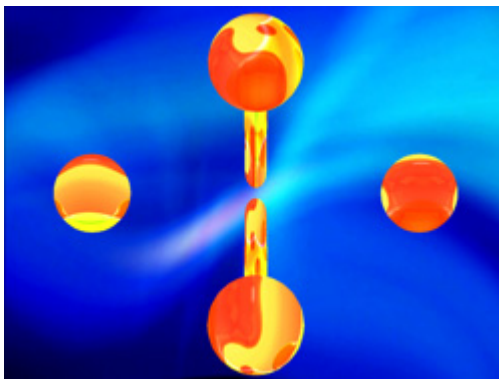

Object 1: Z Position DMX value = 32822

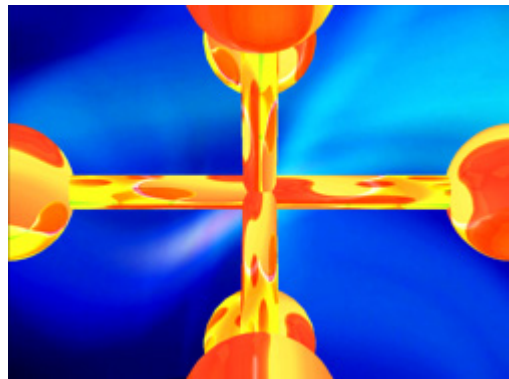

Object 1: Z Position DMX value = 33144

Chapter 9:

Graphic Functions: Opacity and Effects

You can adjust opacity and apply a variety of color mixing and geometric effects to each individual Graphic Object.

The parameters described in this chapter are set for each Graphic Object you define. Parameters for composite image intensity and effects are described in *Chapter 11: Global Functions on page 111*.

NOTE: *The suggested default DMX values given for each parameter are recommended to build libraries that provide the easiest and most reliable content selection, rendering and output.*

Opacity

Adjusting an object's opacity allows one object to "show through" another. You can adjust the opacity of an individual 3-D object from completely transparent to full opacity using this parameter. Increase opacity from not visible at a value of zero to full opacity at a value of 255.

Default DMX Value: 0 = completely transparent

The Global Intensity parameter provides a similar adjustment to the combined image. This global control parameter controls intensity levels on the overall image (see *Global Intensity* on page 111). When you have multiple objects in relation to each other, the Global Intensity parameter is the best way to apply a fade to the composite image.

Tip: The **Dimmer**, **Object Opacity** and **Global Intensity** parameters all have to be greater than 0 to make a defined image visible.

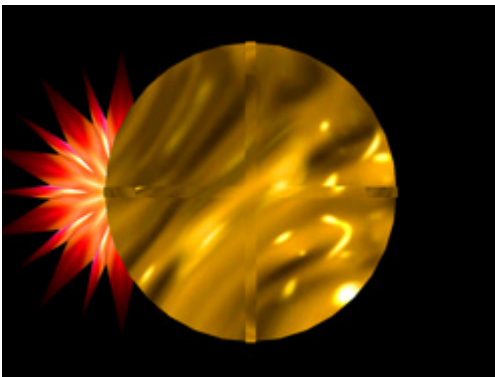

Graphic Object 1 Intensity DMX = 255 (100%)
Graphic Object 2 Intensity DMX = 255 (100%)

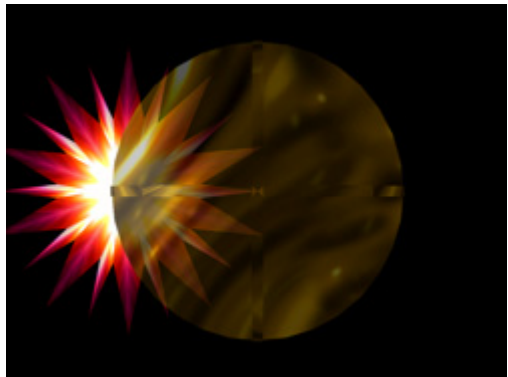

Graphic Object 1 Intensity DMX = 255 (100%)
Graphic Object 2 Intensity DMX = 179 (70%)

Visual Mode

Visual Mode options are defined using three parameters. The **Visual Mode** parameter has options for enhancing and adjusting the black level and contrast of a 3-D object. Once you choose a visual mode, two **Modifier** parameters adjust the selected mode.

NOTE: *In most cases, you won't see a change in the content until you adjust the Modifier parameters for that mode.*

Default DMX Value: 0 = Safe (no processing applied)

Default DMX values for Modifier 1 and Modifier 2 channels depend on the selected option.

The following table illustrates the interaction between the Visual Mode Parameter and the two associated Modifier parameters for each option.

Visual Mode Option			Adjustments	
DMX Value	Name	Description	Modifier 1	Modifier 2
0	Safe	No visual mode processing applied to rendered output.	Not Used	Not Used
1	Content Optimization	Enhances image black level and contrast	Adjusts Back Level	Adjusts Contrast
2	Push to Sepia	Fades from original image color to sepia	Adjusts Fade	Adjusts Saturation
3	Push to Red	Fades from original image color to red tones	Adjusts Fade	Adjusts Saturation
4	Graymaker	Gradually transitions image from color to grayscale	Replaces color with gray	Adjusts brightness
5	Graymaker2	Converts image to grayscale	Adjusts black level	Adjusts contrast
6	Posterizer	Converts colors to their highest values without bleeding or blending	Reduces color detail	Adjusts Contrast
7	Color to B/W	Fades colors to black/white with no grays	Fades color through B/W to White at 100%	Not Used
8	Fire Gradient	Maps original color intensity levels to a red-to-yellow gradient.	Fades image to red-yellow gradient	Not Used
9	Negative Art	Reverses image color	Scales color	Subtract red to Subtract Green
10	Exposure Control	Alternate content optimization option	Expand/Contrast Color	Adjusts color shift
11	Invert B/W	Inverts Black and White components. Color remains unaffected	Sets Black Comparison Level	Sets White Comparison Level
12	Texture Mixing	Crossfades between the current image and another graphic object texture.	Selects the Source Graphic Object Texture	Controls Crossfade

Visual Mode Option			Adjustments	
DMX Value	Name	Description	Modifier 1	Modifier 2
13	Image Scale and Rotate	Scales and rotates the media file texture applied to a 3-D object	Scales Image	Sets Rotation Angle
14	Film Roll	Scrolls the media file texture horizontally or vertically	Sets Horizontal Roll Speed	Sets Vertical Roll Speed
15	Pixelate	Divides the image into rectangles using the center pixel color of each "box" as its color	Adjusts amount of pixelation	Not Used
16	Faux LED	Divides the image into a grid of circles to mimic an LED wall	Varies grid from 100x100 to 10x10	Varies the spacing and B/W
17	Faux Tile	Divides the image into square tiles	Varies grid from 100x100 to 10x10	Varies the spacing and B/W
18	Fuzzifier	Creates a multi-image blurring effect	Horizontal fuzz distance	Vertical fuzz distance
19	Drop Shadow	Creates a scalable drop shadow behind the graphic object	Horizontal shadow size	Vertical shadow size
20	Zoom Blur	Zooms into a position on the image with a multi-image blurring effect	Sets horizontal position center	Sets vertical position center
21	Chroma Shift	Shifts the red, blue, and green component colors	Horizontal shift	Vertical shift
22	ShakeNBake	Introduces a random vibration effect	Horizontal shake	Vertical shake
23	CTO/CTB	Color temperature correction	Push to Orange	Push to Blue
24	Flip	Flips layer content	Horizontal flip	Vertical flip
255	Pan and Scan	Zooms in and pans across a still image	Horizontal position	Vertical position

Visual Mode Options

Color to B/W

Visual Mode Parameter DMX value = 7

Begins with a white screen and fades to the original image in black and white. All color is converted.

Modifier 1: Transitions the image from full white at a DMX value of 0 to black and white at a value of 128 (50%). Increasing values above 50% reveals more of the image in black and white to complete at a value of 255 (100%).

Modifier 2: Not Used

Content Optimization

Visual Mode Parameter DMX value = 1

Stock content provided by High End Systems on your DL.3 fixture has been optimized for lighting applications. This option lets you make the same adjustments for User content or camera input. Content Optimization adjusts the image Black level and Contrast to optimize the projected image for your performance environment. You can use it to easily modify the black level and contrast for a specific application. The Exposure Control visual mode option (see *Exposure Control* on page 85) provides an alternative algorithm for accomplishing this optimization.

Modifier 1: Adjusts black level from 0 = no adjustment to 255 (100%) = full black.

Modifier 2: Adjusts contrast from 0 = no adjustment to 255 (100%) for maximum contrast.

Tip: All the factory content provided has been optimized already. This parameter and the Exposure Control visual options are especially useful for optimizing User content or camera capture.

Chroma Shift

Visual Mode Parameter DMX value = 21

Shifts the red, blue, and green component colors in an image. You can offset color components vertically and or horizontally.

Modifier 1: The default DMX value of 128 (50%) = no adjustment. Values below the midpoint shift the color components right to a maximum at a value of 0. Values above the midpoint shift the color components left to a maximum at a value of 255 (100%).

Modifier 2: The default DMX value of 128 (50%) = no adjustment. Values below the midpoint shift the color components down to a maximum at a value of 0. Values above the midpoint shift the color components up to a maximum at a value of 255 (100%).



Original Content

Visual Mode Parameter DMX value = 21



Visual Mode Modifier 1 DMX value=105

Visual Mode Modifier 2 DMX value=148

CTO/CTB

Visual Mode Parameter DMX value = 23

Allows color temperature correction by adding either Color Temperature Orange or Color Temperature Blue.

Modifier 1: Decreases the perceived color temperature by adding orange from 0 = no adjustment to a minimum color temperature at a value of 255 (100%).

Modifier 2: Increases the perceived color temperature by adding blue from 0 = no adjustment to a maximum color temperature at a value of 255 (100%).

Drop Shadow

Visual Mode Parameter DMX value = 19

You can create a drop shadow behind the media file texture on a 3D object, and vary its size horizontally and vertically. This option creates a black plane behind the selected media file texture on a flat rectangular object that can be positioned to form a drop shadow effect. You won't see the shadow until you select a Modifier 1 or 2 DMX value above or below 128 (50%)

Modifier 1: The default DMX value of 128 (50%) = no adjustment. Values below the midpoint move the "shadow" right as you approach 0 = maximum horizontal shadow width. Values above the midpoint move the "shadow" left as you approach 0 = maximum horizontal shadow width at a value of 255 (100%)

Modifier 2: The default DMX value of 128 (50%) = no adjustment. Values below the midpoint move the "shadow" down as you approach 0 = maximum vertical shadow width. Values above the midpoint move the "shadow" up as you approach 0 = maximum vertical shadow width at a value of 255 (100%).



Original Content

Visual Mode Parameter DMX value = 19



Visual Mode Parameter DMX value = 19

Visual Mode Modifier 1 DMX value= 0

Visual Mode Modifier 2 DMX value=255

Exposure Control

Visual Mode Parameter DMX value = 10

Exposure Control adjusts the image Black level and Contrast to optimize the projected image for your performance environment. You can use it to easily modify the black level and contrast for a specific application.

Exposure Control provides finer Contrast and Black level control than the Content Optimization option (see *page 82*) which pushes colors to saturation more quickly.

Modifier 1: Adjusts black level from 0 = full black through 255 (100%) = brightest. At a DMX value of 128 (50%) there is no adjustment.

Modifier 2: from 0 = least contrast through 255 (100%) = maximum contrast. At a DMX value of 128 (50%) there is no adjustment.

Tip: All the factory content provided has been optimized already. This parameter and the Content Optimization option are especially useful for optimizing user content or camera capture.

Faux LED

Visual Mode parameter DMX value = 16

This option divides the image into a grid of circles to mimic an LED wall. The color of the center pixel in each cell defines the solid color for that circle. You can control the number and spacing of LEDs and choose between a black and white background grid.

Modifier 1: Controls the number of LEDs. The default DMX value of 0 = a 10 x 10 grid of tiles. Increasing the DMX value increases grid divisions to a maximum of 100 x 100 tiles at a value of 255 (100%).

NOTE: *A small number of larger tiles will also result in reduced color variation.*

Modifier 2: Adjusts the LED spacing. DMX values below the midpoint of the range increase the spacing between tiles on a black background from 0 to a maximum space between tiles at a DMX value of 127. Values above the midpoint increase the spacing between tiles on a white background to a maximum space between tiles at a DMX value of 255 (100%).

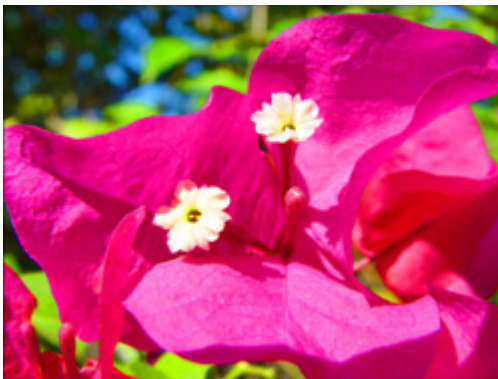

Original Content

Visual Mode Parameter DMX value = 16



Visual Mode Modifier 1 DMX value =204,
Visual Mode Modifier 2 DMX value= 16

Faux Tile

Visual Mode parameter DMX value = 17

This option divides the image into a grid of tiles. The color of the center pixel in each cell defines the solid color for that tile. You can control the number and spacing of tile and choose between a black and white background grid.

Modifier 1: Controls the number of tiles. The default DMX value of 0 = a 10 x 10 grid of tiles. Increasing the DMX value increases grid divisions to a maximum of 100 x 100 tiles at a value of 255 (100%).

NOTE: *A small number of larger tiles will also result in reduced color variation.*

Modifier 2: Adjusts the grid thickness around each tile. DMX values below the midpoint of the range increase the spacing between tiles on a black background from 0 to a maximum space between tiles at a DMX value of 127. Values above the midpoint increase the spacing between tiles on a white background to a maximum space between tiles at a DMX value of 255 (100%).

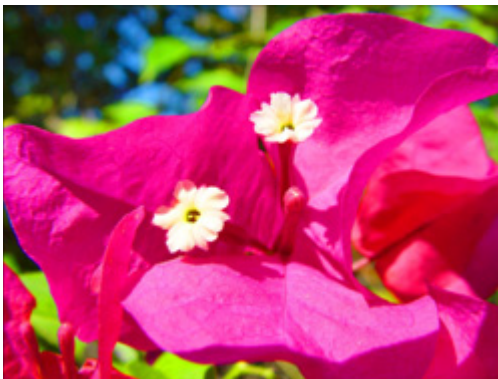

Original Content

Visual Mode Parameter DMX value = 17

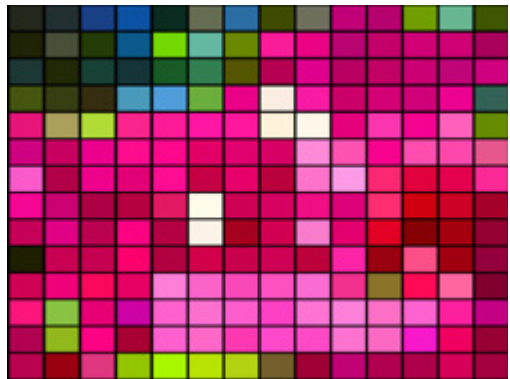

Visual Mode Modifier 1 DMX value =255

Visual Mode Modifier 2 DMX value= 0

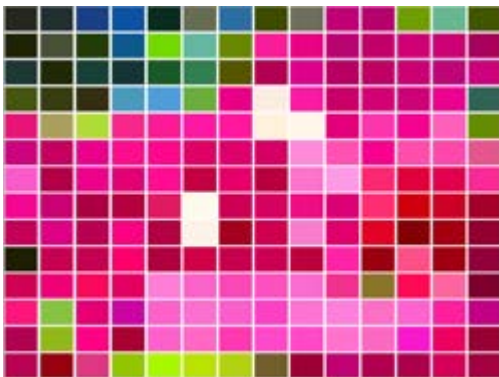

Visual Mode Modifier 1 DMX value =255

Visual Mode Modifier 2 DMX value= 138

Film Roll

Visual Mode parameter DMX value = 14

This option scrolls the media file texture horizontally or vertically independent from the 3-D object it overlays, and allows you to control the scrolling speed.

Modifier 1: The default DMX value of 128 (50%) = no adjustment. Values below the midpoint scroll left, increasing in speed as you approach 0. Values above the midpoint scroll right, increasing in speed to 255 (100%).

Modifier 2: The default DMX value of 128 (50%) = no adjustment. Values below the midpoint scroll down, increasing in speed as you approach 0. Values above the midpoint scroll up, increasing in speed to 255 (100%).

Fire Gradient

Visual Mode Parameter DMX value = 8

This option maps image colors to a Red-to-Yellow gradient creating a fiery effect.

Modifier 1: Maps the image color values from no adjustment at a value of 0 to all red to yellow tones at a value of 255 (100%).

Modifier 2: Not Used

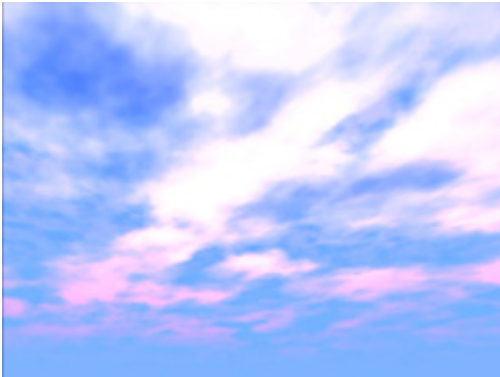

Original Content
Visual Mode Parameter DMX value = 8

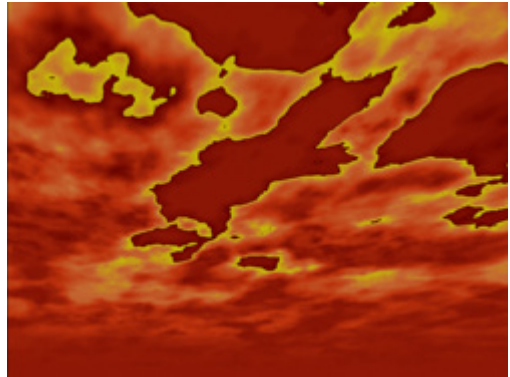

Visual Mode Modifier 1 DMX value=255 (100%)

Flip

Visual Mode parameter DMX value = 24

This option flips the media file texture horizontally or vertically independent from the 3-D object it overlays.

Modifier 1: DMX values from 0-127 have no effect. DMX values of 128 (50%) to = 255 (100%) flips the image horizontally.

Modifier 2: DMX values from 0-127 have no effect. DMX values of 128 (50%) to = 255 (100%) flips the image vertically.



Original content



Modifier 1 parameter DMX = 128
Modifier 2 parameter DMX = 0

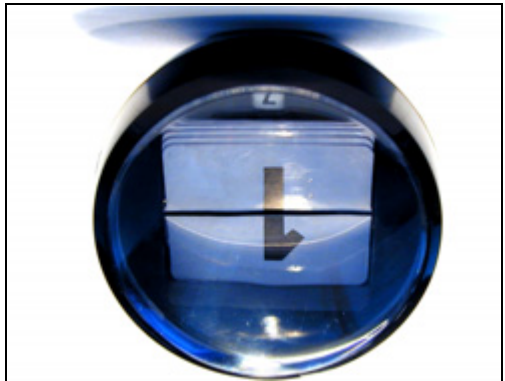

Modifier 1 parameter DMX = 128
Modifier 2 parameter DMX = 128

Fuzzifier

Visual Mode parameter DMX value = 18

This option blurs the media file texture horizontally or vertically.

Modifier 1: The default DMX value of 0 = no adjustment. Increasing DMX values blur the image horizontally to a maximum at a DMX value of 255 (100%).

Modifier 2: The default DMX value of 0 = no adjustment. Increasing DMX values blur the image vertically to a maximum at a DMX value of 255 (100%).

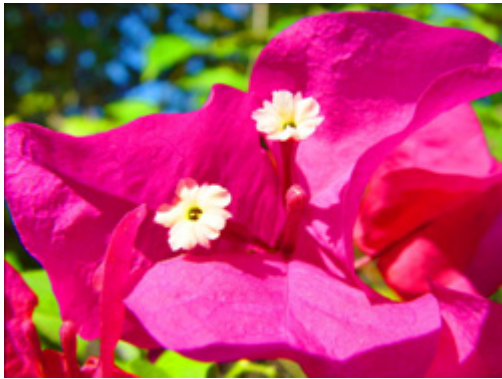

Original Content

Visual Mode Parameter DMX value = 18



Visual Mode Modifier 1 DMX value=255 (100%)

Visual Mode Modifier 2 DMX value=255 (100%)

Gray maker I

Visual Mode Parameter DMX value = 4

This effect gradually transitions the color image to a grayscale image. Use the Gray Maker effect when you want to add an undertone of grey to the colors in an image.

NOTE: *If content is already grayscale, there is no effect applied but Modifier 2 can still affect image contrast.*

Modifier 1: At a DMX value of 0, the image will be full color. As you increase the DMX value, more gray is introduced until, at a DMX value of 255, all color has been replaced with shades of gray.

Modifier 2: Adjusts the brightness of the image at the grayscale transition level selected with the Modifier 1 parameter.



Original Content
Visual Mode Parameter DMX value = 4



Visual Mode Parameter DMX value = 4
Visual Mode Modifier1 DMX value=128(50%)



Visual Mode Parameter DMX value = 4
Visual Mode Modifier1 DMX value=190(75%)
Visual Mode Modifier2 DMX value=255(100%)

Gray maker 2

Visual Mode Parameter DMX value = 5

This option converts a color image to grayscale and then lets you adjust black level and contrast.

Modifier 1: Adjusts the black level of the grayscale image from a DMX value of 0 = Full brightness to 255 = completely black

Modifier 2: Adjusts contrast of the grayscale image from 0 = no adjustment to 255 (100%) = maximum contrast



Original Content



Visual Mode Parameter DMX value = 4



Visual Mode Parameter DMX value = 4
Visual Mode Modifier1 DMX value=90(33.3%)
Visual Mode Modifier2 DMX value=175(77%)

Invert Black and White, Keep Color

Visual Mode Parameter DMX value = 11

This option allows you to invert the black and white components of an image while leaving other colors unaffected. You can vary the threshold for the “black” in a pixel required for inversion.

Modifier 1: Adjusts the comparison level of black for inversion from a DMX value of 0= inverting only absolute black to 255 (100%) = converting more of the image from black to white.

Modifier 2: Adjusts the comparison level of white for inversion from a DMX value of 0= inverting only absolute white to 255 (100%) = converting more of the image from white to black.

Negative Art

Visual Mode Parameter DMX value = 9

This option provides a negative of the image and then lets you adjust the amount of color and the red and green color components.

Modifier 1: Adjusts the color level from full at a DMX value of 0 to the lowest level at a DMX value of 255.

Modifier 2: You must set a DMX value of 128 to see no black level adjustment. Red is subtracted from the image at DMX values of 128 to 0. Green is subtracted from the image at DMX values of 129 – 255.



Original Content

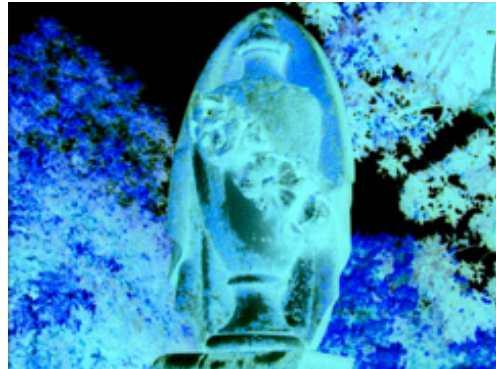

Visual Mode Parameter DMX value = 9
Modifier 1 DMX value=0
Modifier 2 DMX value = 0



Visual Mode Parameter DMX value = 9
Modifier 1 DMX value=0
Modifier 2 DMX value = 128 (50%)



Visual Mode Parameter DMX value = 9
Modifier 1 DMX value=255 (100%)
Modifier 2 DMX value = 128 (50%)

Pan and Scan

Visual Mode parameter DMX value = 255

This option Zooms into a still image and then, by changing position, you can pan across the image horizontally and vertically. It only functions on image sizes greater than 1024 x 1024 in at least one direction.

Modifier 1: Adjusts the horizontal pan position from 0=left edge to 255 (100%) = right edge of the image. The default DMX value of 128 (50%) = no adjustment.

Modifier 2: Adjusts the vertical pan position from 0 = bottom edge to 255 (100%) = top edge of the image. The default DMX value of 128 (50%) = no adjustment.



Original Content

Visual Mode Parameter DMX value = 255



Visual Mode Modifier1 DMX value=128

Visual Mode Modifier 2 DMX value = 128



Visual Mode Modifier 1 DMX value = 0

Visual Mode Modifier 2 DMX value = 0



Visual Mode Modifier 1 DMX value = 255

Visual Mode Modifier 2 DMX value = 255

Pixelate

Visual Mode parameter DMX value = 15

This options divides the image into rectangles using the center pixel color of each as its color. You can control the number of divisions.

Modifier 1: Controls the number of divisions from a single cell at a DMX value = 0 to the maximum number of cells at a DMX value = 255 (100%). Since each division is a single color, fewer, larger boxes result in reduced color variation.

Modifier 2: Not Used

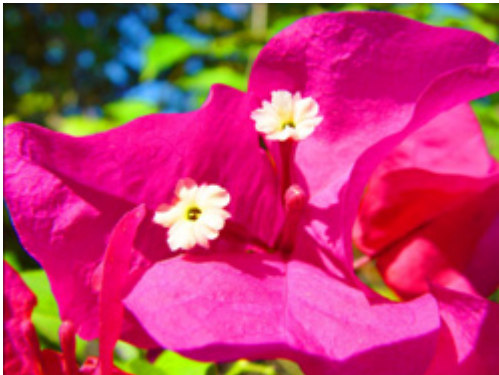

Original Content

Visual Mode Parameter DMX value = 15

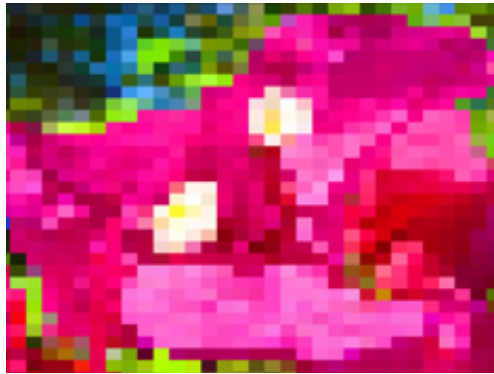

Visual Mode Modifier 1 DMX value = 128

Posterizer

Visual Mode Parameter DMX value = 6

This effect uses the associated **Modifier 1** parameter to posterize by replacing each color in an image with the highest values of that color but expanding it only to the border of that color. There is no bleeding or blending of colors.

NOTE: *In this visual mode, you won't see a change in the image until you adjust the Modifier 1 parameter*

Modifier 1: Adjusts color polarization level. The higher the value, the more color detail will be removed.

Modifier 2: Adjust the image contrast from 0 = no adjustment to 255 (100%) = maximum contrast.



Original Content
Visual Mode Parameter DMX value = 6



Visual Mode Parameter DMX value = 6
Visual Mode Modifier 2 DMX value=255(100%)



Visual Mode Parameter DMX value = 6
Visual Mode Modifier1 DMX value=190(75%)
Visual Mode Modifier2 DMX value=255(100%)

Push to Red

Visual Mode Parameter DMX value = 3

This option reduces colors in the selected image to all Red values

Modifier 1: Fades from original color at a DMX value = 0 to a range of red tones at a value of 255 (100%)

Modifier 2: Adjusts color saturation from no adjustment at a DMX value = 0 to full saturation at a value of 255 (100%)



Original Content
Visual Mode Parameter DMX value = 3



Visual Mode Parameter DMX value = 3
Visual Mode Modifier2 DMX value=255(100%)



Visual Mode Parameter DMX value = 3
Visual Mode Modifier1 DMX value=190(75%)
Visual Mode Modifier2 DMX value=255(100%)

Push to Sepia

Visual Mode Parameter DMX value = 2

This option converts all color in the image to sepia tones.

Modifier 1: Fades from original color at a DMX value = 0 to a range of sepia shades at a value of 255 (100%)

Modifier 2: Adjusts color saturation from no adjustment at a DMX value = 0 to full saturation at a value of 255 (100%)



Original Content

Visual Mode Parameter DMX value = 2



Visual Mode Parameter DMX value = 2

Visual Mode Modifier2 DMX value=255(100%)



Visual Mode Parameter DMX value = 2

Visual Mode Modifier1 DMX value=190(75%)

Visual Mode Modifier2 DMX value=255(100%)

ShakeNBake

Visual Mode Parameter DMX value = 22

This option randomly vibrates the image. You can control the horizontal and vertical frequency.

Modifier 1: Adjusts random horizontal “shake” frequency from 0= no adjustment to 255 (100%) = maximum.

Modifier 2: Adjusts random vertical “shake” frequency from 0= no adjustment to 255 (100%) = maximum.

Texture Mixing

Visual Mode Parameter DMX value = 12

Texture Mixing lets you crossfade from textures (media file content) of one Graphic Object to the texture of another Graphic Object. Any effects applied to the Source file do not display.

Modifier 1: Selects the Source file for the texture you want to pull. A DMX value = 1 selects Graphic Object 1’s media file content. A DMX value = 2 selects Graphic Object 2’s media file content. A DMX value = 3 selects Graphic Object 3’s media file content.

Modifier 2: Adjusts Graphic Object opacity of the source texture from a DMX value of 0 = fully transparent to 255 (100%) = fully opaque.



Original Content Object 1
Visual Mode Parameter DMX value = 20

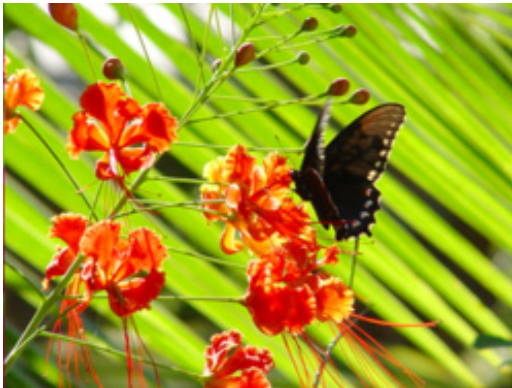

Original Content Object 2
Visual Mode Parameter DMX value = 20



Visual Mode Modifier 1 DMX value=1
Visual Mode Modifier 2 DMX value=128

Zoom Blur

Visual Mode Parameter DMX value = 20

Zooms into a position on the image with a multi-image blurring effect. You can control the position of the zoom center on the image.

Modifier 1: Selects the horizontal center of the zoom point.

Modifier 2: Selects the vertical center of the zoom point.



Original Content

Visual Mode Parameter DMX value = 20



Visual Mode Modifier 1 DMX value=158

Visual Mode Modifier 2 DMX value=168

Effect Mode Parameters

Three **Effect Mode** parameters are available for each individual 3-D object, each with three **Modifier** parameters. Both Effect parameters have an identical list of color and visual effect options. This lets you apply a dual-effect combination to the selected 3-D object.

NOTE: *Not all modes combine effectively. For example, you cannot glow a wobulating object very well.*

The table below describes the interaction between an Effect Mode parameter and its three associated Modifier parameters. You can find a detailed description and example of each option in *Chapter 13: Effect Mode Options Descriptions* on page 143.

NOTE: *Modifier channels for Effect Mode 1 are labeled as CMY in the Wholehog system so you can also make use of the color picker, HSI, and other Wholehog functions. Use the CMY parameter controls to adjust the three Effect Mode 1 Modifier parameters for both the Global and Graphic fixture types. The default for Effect Mode 1 is set to CMY1 as well. Effect Mode 2 and 3 Modifier channels are labeled Mod 1, Mod 2, and Mod 3.*

DMX value	Name/Description	Adjustments		
		Modifier 1	Modifier 2	Modifier 3
0	Safe (no effects selection)	NA	NA	NA
1	CMY (RGB invert)	Cyan	Magenta	Yellow
2	CMY Add, All Pixels	Cyan	Magenta	Yellow
3	CMY Add, All Non-black Pixels	Cyan	Magenta	Yellow
4	RGB Add, All Pixels	Red	Green	Blue
5	RGB Add 2, All Pixels	Red	Green	Blue
6	RGB Add, All Non-black Pixels	Red	Green	Blue
7	RGB Swap to GBR	Red to Green	Green to Blue	Blue to Red
8	RGB Swap to BRG	Red to Blue	Green to Red	Blue to Green
9	Solarize 1 inverts a color value < DMX value	Red	Green	Blue
10	Solarize 2 inverts a color if value > DMX value	Red	Green	Blue
11	Solarize 3 sets color to 0 if value < DMX value	Red	Green	Blue
12	Solarize 4 sets color to 0 if value > DMX value	Red	Green	Blue
13	DotP and Resample	Red	Green	Blue
14	Color Cycle cycles colors with DMX value controlling cycle speed.	Red	Green	Blue
15	All or Nothing sets color values > mod value = 255 and all other color values = 0	Red	Green	Blue
16	Solid color RGB	Red	Green	Blue

DMX value	Name/Description	Adjustments		
		Modifier 1	Modifier 2	Modifier 3
17	RGB Invert	From Red to Cyan	From Green to Magenta	From Blue to Yellow
18	RGB, Invert and Swap to GBR	Red to Green	Green to Blue	Blue to Red
19	RGB, Invert and Swap to BRG	Red to Blue	Green to Red	Blue to Green
20	Edge Detect Color	Horizontal search size	Vertical search size	Comparison threshold
21	Edge Detect B/W	Horizontal search size	Vertical search size	Comparison threshold
22	Texture Ripple, Horizontal	Amplitude	Frequency	Phase
23	Texture Ripple, Vertical	Amplitude	Frequency	Phase
24	Texture Ripple, Circular	Amplitude	Frequency	Phase + Direction
25	Texture Ripple, Circular Asymmetrical	Amplitude	Frequency	Phase
26	Transparent Color Fine selects key color using Modifier channels	Red	Green	Blue
27	Transparent Color Medium selects key color using Modifier channels	Red	Green	Blue
28	Transparent Color Coarse selects key color using Modifier channels	Red	Green	Blue
29	Transparent Color Invert, Fine selects key color using Modifier channels	Red	Green	Blue
30	Transparent Color Invert, Medium selects key color using Modifier channels	Red	Green	Blue
31	Transparent Color Invert, Coarse selects key color using Modifier channels	Red	Green	Blue
32	Scan Line converts image colors to colors in a single line of the image	Selects scan line	Fades to converted image	Not used
33	Transparent Wipes “opens” the selected graphic to reveal another graphic positioned behind it	Area of wipe	Selects center of wipe	Selects from 6 wipe options
34	Pixel Twist swirls a portion of the texture	Twist center on X axis	Twist center on Y axis	Direction and amount of twist
35	Picture-in-picture duplicates the texture and overlays it on the original	Subpicture center on X axis	Subpicture center on Y axis	Subpicture size
36	Magnifying Lens creates a virtual convex lens that magnifies a portion of the texture	Lens center on X axis	Lens center on Y axis	Lens size
37	Magnifying Lens 2 creates a virtual double convex lens that magnifies a portion of the texture.	Lens center on X axis	Lens center on Y axis	Lens size
38	Cartoon Edge creates variable outline around picture elements	Reduces Color	Enhances Contrast	Edge detection sensitivity

DMX value	Name/Description	Adjustments		
		Modifier 1	Modifier 2	Modifier 3
39	Color DeConverge separates image color components and offsets them	Moves Red component up	Moves Green component down and right	Moves Blue component down and left
40	Horizontal Mirror creates a mirror effect	Defines mirror center	Not Used	Not Used
41	RGB Swap to BGR redefines component color	Red to Blue	Green	Blue to Red
42	RGB Swap to RBG redefines component color	Red	Green to Blue	Blue to Green
43	RGB Swap to GRB redefines component color	Red to Green	Green to Red	Blue
44	Colorize Gray Scale maps pixel intensity to color	Selects Color Scheme	Selects zero intensity point	Controls fading
45	Intensity Key turns pixels of selected intensity transparent	Selects Color Scheme	Sets Intensity bandwidth	Controls Transparency
46	Raindrop simulates raindrops falling on a liquid surface	Controls size/speed	Seeds random # generator	Controls raindrop rate
47	RGB, Scale varies the color mapping values	Red	Green	Blue
48	Tiling On multiplies image in a defined grid	Horizontal #	Vertical #	Space between tiles
49	Color to Alpha varies the transparency level of an image's component color values	Red to alpha	Green to alpha	Blue to alpha
50	Color to Alpha, Inverted varies the transparency level of an image's inverted color values	Inverted Red to alpha	Inverted Green to alpha	Inverted Blue to alpha
51	Texture Mixing crossfades between the current image and another graphic object texture	Selects Source Texture	Selects Source Effect Level	Crossfade Between Textures
52	Image Scale and Rotate Scales and rotates the media file texture applied to a 3-D object	Scales image	Selects Rotation Angle	Sets Rotation Speed
53	Film Roll scrolls the media file texture horizontally or vertically	Horizontal roll speed	Vertical roll speed	Scales Image
54	Pixelate divides the image into rectangles using the center pixel color of each "box" as its color	Sets amount of Pixelation	Scales horizontally	Scales vertically
55	Faux LED divides the image into a grid of circles to mimic an LED wall	LED size	Spacing	Color peaking
56	Faux Tile divides the image into square tiles	Tile Size	Spacing	Color peaking
57	Fuzzifier creates a multi-image blurring effect	Horizontal distance	Vertical distance	Fuzz Decay
58	Drop Shadow creates a scalable drop shadow behind the graphic object	Horizontal shadow size	Vertical shadow size	Shadow opacity
59	Zoom Blur zooms into a position on the image with a multi-image blurring effect	Horizontal position center	Vertical position center	Zoom in and out

DMX value	Name/Description	Adjustments		
		Modifier 1	Modifier 2	Modifier 3
60	Chroma Shift shifts the red, blue, and green component colors	Horizontal shift	Vertical shift	Not Used
61	ShakeNBake introduces a random vibration effect	Horizontal Shake	Vertical Shake	Scale
62	Slats, Vertical renders the image in offset vertical slats	Number of Slats	Vertical Displacement	Fade from Normal to Slats
63	Slats, Horizontal renders the image in offset horizontal slats	Number of Slats	Horizontal Displacement	Fade from Normal to Slats
80	Downward Vertical Streaks “pulls” the image down	Vertical Start Position	Streak Angle	Fade from Normal to Streak
81	Gaussian Blur blurs the image	Sample Distance	Number of Filter Passes	Scales the Effect
82	Sharpen	Sample Distance	Number of Filter Passes	Scales the Sharpen Effect
83	Flip	Horizontal Flip	Vertical Flip	Not Used
84	UV to Gray turns everything in the image gray except for a selected UV chroma coordinate	U Coordinate	V Coordinate	Tolerance
85	UV to Transparent turns everything in the image transparent except for a selected UV chroma coordinate.	U Coordinate	V Coordinate	Tolerance
86	UV Select to Transparent turns a selected UV chroma coordinate transparent with the rest of the image unchanged	U Coordinate	V Coordinate	Tolerance
87	HS to Gray retains selected hue and saturation, and turns everything else gray.	Hue Coordinate	Saturation Coordinate	Tolerance
88	HS to Transparent retains selected hue and saturation, and turns everything else transparent.	Hue Coordinate	Saturation Coordinate	Tolerance
89	HS Selected To Transparent makes selected hue and saturation transparent	Hue Coordinate	Saturation Coordinate	Tolerance
90	Texture Shift shifts texture coordinate by color value	Horizontal Shift	Vertical Shift	Color and Scale
91	Lens Grid views texture through grid of lenses	Magnification	Edge Shading	# of Lenses
92	Edge Detect, BW2 detects edges as black or white	Sample Distance	Edge Threshold Comparison	Detected Edge Scaler
93	Film Burn/Unburn creates burn pattern over image	Burn Through Rate	Film Blackening	Burn Pattern
94	Film Noise creates an “aged” film look	Noise Rate	Push to Sepia add Jitter	Noise Level
95	Particle System 1 converts image to a particle pattern	Emitter Type	Trail Length	Particle Acceleration

DMX value	Name/Description	Adjustments		
		Modifier 1	Modifier 2	Modifier 3
96	Particle System 2 adds adjustments to Effect 95	Number of Particles	Particle Size	Emitter Size
97	Particle System 3 adds adjustments to Effect 95 + Effect 96	Initial Particle Velocity	Particle Rotation	Particle Lifetime
98	Prism	Number of Facets	Refraction Index	Rotation
99	Gaussian Halo creates blur from a clear center toward edges	Sample Distance	Number of Filter Passes	Gaussian Curve Shape
100	Scene Change Detect transparency effect	Scale RGB	Scale Alpha	Scale RGB+ alpha
101	Xy Luminance Scaling adjusts brightness independent of color values	Scale Luminance	Scale X	Scale y
102	Prerotatation Translation sets image in virtual 3-D space for rotation	Translate X	Translate Y	Translate Z
103	Digital Mspeed	Rotation MSpeed	Scaling MSpeed	Position MSpeed
253	Special value used with global spherical mapping effect 142. Defaults to 0 otherwise.	NA	NA	NA
254	Special value used with global spherical mapping effect 142. Defaults to 0 otherwise.	NA	NA	NA
255	Pan and Scale zooms in and pans across a still image	Horizontal position	Vertical position	Zoom in and out

Chapter 10:

Graphic Functions: Synchronizing Content

After designating a master fixture, you can synchronize the content of other Axon, DL.3, or DL.2 fixtures to any Graphic Object on the master in terms of playback time, rotation or both.

Network Synchronization Overview

Network Synchronization allows for certain functions of DL.3, DL.2 or Axon media servers to be synchronized over an Ethernet network. This can be extremely useful in situations such as using the Collage Generator to ensure a seamless image with multiple media servers.

Network Synchronization is done using a reference *master* server that sends certain information about its current playback and output to the other fixtures on the network through Ethernet packets. The other servers, or *slave* servers use this information to set their playback and effects timing the same as the *master* server.

Network Synchronization is not slaving. With slaving, the master fixture's DMX values for synchronized functions would override the DMX values in the slave servers. When you use Network Synchronization, the appropriate DMX channels for all the *slave* fixtures and the *master* fixture must be set to the same values.

Network Synchronization Requirements

In order for Network Synchronization to function properly, there are a few requirements that must be adhered to in the set-up of the fixtures:

- All of the servers must be linked on an Ethernet network. This network can be set up with Auto-IP addresses or DHCP addresses.
- The Fixture ID for each media server in the network must be unique. The Fixture ID is used to assign the *master* and *slave* servers and having multiple media servers with the same ID will cause the Synchronization information being sent over the network to be processed incorrectly.

A fixture ID default of 1 is assigned to every DL.3, DL.2 and Axon server on your Ethernet fixture network. For synchronization to work, you will need to assign each DL.3, DL.2 and Axon server a Unique Fixture ID from 1 to 255 using the CMA (see *DL.3 and DL.2 Media Server Configuration Options* on page 276 and *Axon Media Server Configuration Options* on page 285) or through the onboard Menu System (for DL.3 and DL.2 fixtures).

- All video content to be used in a Synchronization scenario MUST adhere to the High End Systems requirements for encoding custom content for DL.3, DL.2 and Axon servers. If

the content is not encoded correctly, not only will the Network Synchronization not function, but other problems with video playback (such as stuttering or jumping in the clips) can occur.

Network Synchronization Capabilities

As currently implemented, it is possible to synchronize movie playback as well as certain graphics effects.

Movie Playback Synchronization ensures that movie playback between multiple servers stays Synchronized for either collage applications or where multiple servers are playing the same movie clip on different projection surfaces. It is especially useful for long movie clips and will solve the problems of frame drift that can be associated with media server playback.

Certain effects in the graphics engine can also be synchronized between servers. Effects such as the ripple effects, object wobblulation, or color cycle effects need to be synchronized between servers to appear correctly in Collage usage scenarios.

Programming Synchronization

To program synchronization, first start by deciding which fixture/server will be the master server. This can be any server on the link. However, in a case of mixed computer hardware in the servers, the oldest server should be chosen as the master. This will ensure that all of the servers have the ability to playback content as well as the master server.

Sync To Parameter

Once you have chosen your master server, the **Sync To** parameter must be set on all of the slave servers. This parameter is found on the first Graphic Layer of each server. The **Sync To** parameter is set to a value equal to the Fixture ID of your master server. For example, if your master server has a fixture ID of "3", all of the slave servers should have their **Sync To** parameter on Graphic Layer 1 set to "3".

NOTE: *The Sync To parameter is found on each of the Graphic Objects on the server, However, only the Sync To parameter for Graphic Object 1 has any effect. Servers can only sync to one other server, so you cannot have different servers chosen using the Sync to parameter on different graphic object of the same server. If values are set in the Sync To parameter of Graphic Object 2–9, they will be ignored.*

Sync Type Parameter

DMX Default Value: 0 = no sync type selection

Next, set the **Sync Type** parameter to its appropriate value. These are for synchronizing movie playback on any Graphic Object. If all Graphic Object 1s need to synchronize together, set the **Sync Type** parameter on all Graphic Object 1s of the slave servers to Graphic Object 1. The

same goes for synchronizing all of Graphic Objects 2–9. It is possible to synchronize Graphic Object 1 to Graphic Object 3, etc., as long as all of the appropriate parameters are set correctly.

NOTE: *Unlike the Sync To parameter, Sync Type does function on all graphic object layers and must be set in order for Synchronization to function correctly on that particular layer.*

When using the Sync Type parameter, keep the following in mind:

- Any Sync Type value above 45 (46-255) defaults back to 0
- Any settings affected by the synchronize mode you select need to be mirrored on both objects to Sync correctly.
- Setting a Graphic Object to sync to itself will have no effect

There are six sync type options available for each of the nine Graphic Object layers:

- Synchronize to Graphic movie time
- Synchronize to Object rotation
- Synchronize to Object reverse rotation
- Synchronize to Graphic movie time and Object rotation
- Synchronize to Graphic movie time and Object reverse rotation

See *Graphic Synchronization* on page 333 for the DMX values associated with each of these.

Effect Synchronization

Synchronizing Effects happens as soon as the **Sync To** parameter is set on Graphic Layer 1 of a server. No special **Sync Type** setting is needed.

Synchronizing a Server to Itself

Movie playback and effects can be synchronized between a Graphic Object on a single fixture (for example, making sure all Graphic Objects on a single fixture are playing back in sync with one another). This is programmed the same way as Synchronization between servers, except that the **Sync To** parameter is set to its own Fixture ID.

Synchronizing a Master Server to another Server

Even if a server is functioning as a master server, it is still possible to synchronize this server to another server. This can be useful in cases where multiple collages are playing the same movie. A single server in each collage can act as that collage's master, and then those masters can be synchronized together to ensure all collages are in sync. A master server should not be set to sync to one of its own slave servers, however, as this can cause problems with playback.

Chapter II:

Global Functions

Global Graphic controls affect the composite image created by defining multiple separate object graphics. You can adjust intensity, define masks, select a point in space to view the composite image, and control keystone correction.

Global Intensity

The **Global Intensity** parameter creates a smooth *fade to video black* that doesn't affect the opacity relationship between individual objects. Use this parameter to adjust the intensity of a composite image over the separate Graphic Object's Opacity parameter settings. Increase intensity from not visible at a DMX value of 0 to full intensity at a value of 255 (100%).

Default DMX Value: 0 = no intensity (video black)

Tip: The Dimmer, Object Opacity and Global Intensity parameters all need DMX values greater than 0 for a defined image to be visible.

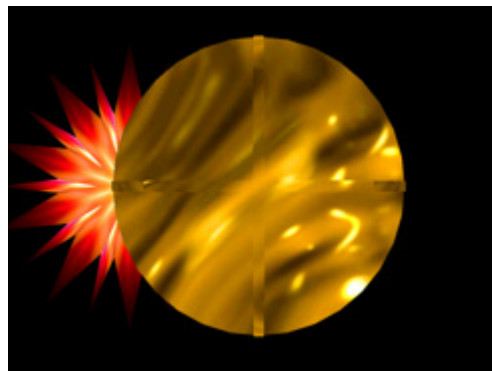

Graphic Object 1 Intensity DMX = 255 (100%)
Graphic Object 2 Intensity DMX = 255 (100%)

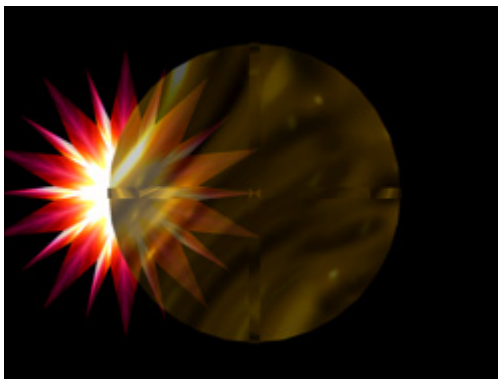

Graphic Object 1 Intensity DMX = 255 (100%)
Graphic Object 2 Intensity DMX = 179 (70%)

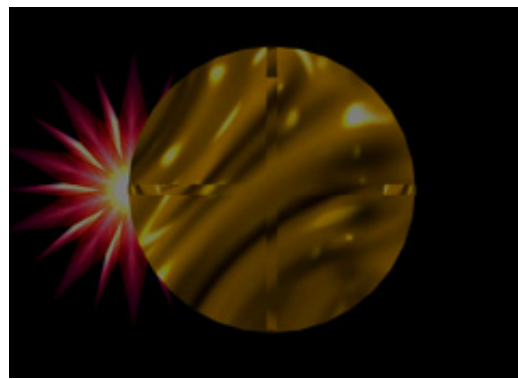

Global Intensity DMX = 128 (50%)

Global Effect Mode Channels

There are five banks of **Global Effect Mode** parameters, each with associated Modifier channels. All **Global Effect Mode** parameters have an identical list of color and visual effect options. This lets you apply a multiple-effect combination to the composite image.

The table below describes the interaction between a **Global Effect Mode** parameter and the three associated **Modifier** parameters for each option. You can find a detailed description of each option in *Chapter 13: Effect Mode Options Descriptions*.

NOTE: *Modifier channels for Effect Mode 1 are labeled as CMY in the Wholehog system so you can also make use of the color picker, HSI, and other Wholehog functions. Use the CMY parameter controls to adjust the three Effect Mode 1 Modifier parameters for both the Global and Graphic fixture types.*

The default for Effect Mode 1 is set to CMY1 as well. Other Effect Mode Modifier channels are labeled Mod 1, Mod 2, and Mod 3.

DMX Value	Effect Mode Name/Description	Adjustments		
		Modifier 1	Modifier 2	Modifier 3
0	Safe (no effects selection)	NA	NA	NA
1	CMY (RGB inverse)	Cyan	Magenta	Yellow
2	CMY Add, All Pixels	Cyan	Magenta	Yellow
3	CMY Add, All Non-black Pixels	Cyan	Magenta	Yellow
4	RGB Add, All Pixels	Red	Green	Blue
5	RGB Add 2, All Pixels	Red	Green	Blue
6	RGB Add, All Non-black Pixels	Red	Green	Blue
7	RGB Swap to GBR	Red to Green	Green to Blue	Blue to Red
8	RGB Swap to BRG	Red to Blue	Green to Red	Blue to Green
9	Solarize 1 inverts a color if value < DMX value	Red	Green	Blue
10	Solarize 2 inverts a color if value > DMX value	Red	Green	Blue
11	Solarize 3 sets color to 0 if value is < DMX value	Red	Green	Blue
12	Solarize 4 sets color to 0 if value is > DMX value	Red	Green	Blue
13	DotP and Resample	Red	Green	Blue
14	Color Cycle cycles colors with DMX value controlling cycle speed.	Red	Green	Blue
15	All or Nothing sets color values > mod value = 255 and all other color values = 0	Red	Green	Blue
16	Solid color RGB	Red	Green	Blue
17	RGB Invert	From Red to Cyan	From Green to Magenta	From Blue to Yellow

DMX Value	Effect Mode Name/Description	Adjustments		
		Modifier 1	Modifier 2	Modifier 3
18	RGB, Invert and Swap to GBR	Red to Green	Green to Blue	Blue to Red
19	RGB, Invert and Swap to BRG	Red to Blue	Green to Red	Blue to Green
20	Edge Detect Color	Horizontal search size	Vertical search size	Comparison threshold
21	Edge Detect B/W	Horizontal search size	Vertical search size	Comparison threshold
22	Texture Ripple, Horizontal	Amplitude	Frequency	Phase
23	Texture Ripple, Vertical	Amplitude	Frequency	Phase
24	Texture Ripple, Circular	Amplitude	Frequency	Phase and Direction
25	Texture Ripple, Circular Asymmetrical	Amplitude	Frequency	Phase
26	Transparent Color Fine selects key color using Modifier channels	Red	Green	Blue
27	Transparent Color Medium selects key color using Modifier channels	Red	Green	Blue
28	Transparent Color Coarse selects key color using Modifier channels	Red	Green	Blue
29	Transparent Color Invert, Fine selects key color using Modifier channels	Red	Green	Blue
30	Transparent Color Invert, Medium selects key color using Modifier channels	Red	Green	Blue
31	Transparent Color Invert, Coarse selects key color using Modifier channels	Red	Green	Blue
32	Scan Line converts image colors to colors in a single line of the image	Selects scan line	Fades to converted image	Not used
33	Transparent Wipes "opens" the selected graphic to reveal another graphic positioned behind it	Area of wipe	Selects center of wipe	Selects from 6 wipe options
34	Pixel Twist swirls a portion of the texture	Twist center on X axis	Twist center on Y axis	Direction and amount of twist
35	Picture-in-picture duplicates the texture and overlays it on the original	Subpicture center on Xaxis	Subpicture center on Yaxis	Subpicture size
36	Magnifying Lens creates a virtual convex lens that magnifies a portion of the texture	Lens center on X axis	Lens center on Y axis	Lens size
37	Magnifying Lens 2 creates a virtual double convex lens that magnifies a portion of the texture.	Lens center on X axis	Lens center on Y axis	Lens size
38	Cartoon Edge creates variable outline around picture elements	Reduces Color	Enhances Contrast	Edge detection sensitivity
39	Color DeConverge separates and offsets image color components from original position	Moves Red up	Moves Green down and right	Moves Blue down and left

DMX Value	Effect Mode Name/Description	Adjustments		
		Modifier 1	Modifier 2	Modifier 3
40	Horizontal Mirror creates a mirror effect	Defines mirror center	Not Used	Not Used
41	RGB Swap to BGR redefines component color	Red to Blue	Green	Blue to Red
42	RGB Swap to RBG redefines component color	Red	Green to Blue	Blue to Green
43	RGB Swap to GRB redefines component color	Red to Green	Green to Red	Blue
44	Colorize Gray Scale maps pixel intensity to color	Selects Color Scheme	Selects zero intensity point	Controls fading
45	Intensity Key turns pixels of selected intensity transparent	Selects Color Scheme	Sets Intensity bandwidth	Controls Transparency
46	Raindrop simulates raindrops falling on a liquid surface	Controls size/speed	Seeds random # generator	Controls raindrop rate
47	RGB, Scale varies the color values	Red	Green	Blue
48	Tiling On multiplies image mapped to a defined grid	Horizontal #	Vertical #	Space between tiles
49	Color to Alpha varies the transparency level of an image's component color values	Red to alpha	Green to alpha	Blue to alpha
50	Color to Alpha, Inverted varies the transparency level of the inverted color values	Inverted Red to alpha	Inverted Green to alpha	Inverted Blue to alpha
51	Texture Mixing crossfades between the current image and another graphic object texture	Selects Source Texture	Selects Source Effect Level	Crossfade Textures
52	Image Scale and Rotate Scales and rotates the media file texture applied to a 3-D object	Scales image	Selects Rotation Angle	Sets Rotation Speed
53	Film Roll scrolls the media file texture horizontally or vertically	Horizontal roll speed	Vertical roll speed	Scales Image
54	Pixelate divides the image into rectangles using the center pixel color of each "box" as it's color	Sets amount of Pixelation	Scales horizontally	Scales vertically
55	Faux LED divides the image into a grid of circles to mimic an LED wall	LED size	Spacing	Color peaking
56	Faux Tile divides the image into square tiles	Tile Size	Spacing	Color peaking
57	Fuzzifier creates a multi-image blurring effect	Horizontal distance	Vertical distance	Fuzz Decay
58	Drop Shadow creates a scalable drop shadow behind the graphic object	Horizontal shadow size	Vertical shadow size	Shadow opacity
59	Zoom Blur zooms into a position on the image with a multi-image blurring effect	Horizontal position center	Vertical position center	Zoom in and out
60	Chroma Shift shifts the red, blue, and green component colors	Horizontal shift	Vertical shift	Not Used

DMX Value	Effect Mode Name/Description	Adjustments		
		Modifier 1	Modifier 2	Modifier 3
61	ShakeNBake introduces a random vibration effect	Horizontal Shake	Vertical Shake	Scale
62	Slats, Vertical renders the image in offset vertical slats	Number of Slats	Vertical Displacement	Fade from Normal to Slats
63	Slats, Horizontal renders the image in offset horizontal slats	Number of Slats	Horizontal Displacement	Fade from Normal to Slats
80	Downward Vertical Streaks “pulls” the image down	Vertical Start Position	Streak Angle	Fade from Normal to Streak
81	Gaussian Blur	Sample Distance	Number of Filter Passes	Scales the Effect
82	Sharpen	Sample Distance	Number of Filter Passes	Scales the Sharpen Effect
83	Flip	Horizontal Flip	Vertical Flip	Not Used
84	UV to Gray turns everything in the image gray except for a selected UV chroma coordinate	U Coordinate	V Coordinate	Tolerance
85	UV to Transparent turns the image transparent except for a selected UV chroma coordinate.	U Coordinate	V Coordinate	Tolerance
86	UV Select to Transparent turns only a selected UV chroma coordinate in the image transparent	U Coordinate	V Coordinate	Tolerance
87	HS to Gray retains selected hue and saturation, and turns everything else gray.	Hue Coordinate	Saturation Coordinate	Tolerance
88	HS to Transparent retains selected hue and saturation, and turns everything else transparent.	Hue Coordinate	Saturation Coordinate	Tolerance
89	HS Selected To Transparent makes selected hue and saturation transparent with the rest of the image unchanged	Hue Coordinate	Saturation Coordinate	Tolerance
90	Texture Shift shifts texture coordinate by color value.	Horizontal Shift	Vertical Shift	Color and Scale
91	Lens Grid views texture through grid of lenses	Magnification	Edge Shading	# of Lenses
92	Edge Detect, BW2 creates a pencil line drawn effect	Sample Distance	Edge Threshold Comparison	Detected Edge Scaler
93	Film Burn/Unburn create a burn pattern on the image	Burn/Unburn Rate	Film Blackening	Burn Pattern
94	Film Noise creates an “aged” film effect	Noise Rate	Push to Sepia add Jitter	Noise Level
95	Particle System 1 converts image to a particle pattern	Emitter Type	Trail Length	Particle Acceleration

DMX Value	Effect Mode Name/Description	Adjustments		
		Modifier 1	Modifier 2	Modifier 3
96	Particle System 2 adds adjustments to Effect 95	Number of Particles	Particle Size	Emitter Size
97	Particle System 3 adds adjustments to Effect 95 + Effect 96	Initial Particle Velocity	Particle Rotation	Particle Lifetime
98	Prism	Number of Facets	Refraction Index	Rotation
99	Gaussian Halo creates blur from clear center toward the edges of an image	Sample Distance	Number of Filter Passes	Gaussian Curve Shape
100	Scene Change Detect transparency effect	Scale RGB	RGB to Alpha	Scale color with alpha applied
101	Yxy Luminance Scaling adjusts brightness without effecting color	Scale Luminance	Scale X	Scale
102	Prerotation Translation places object in 3-D space	Translate X	Translate Y	Translate Z
103	Digital Mspeed.	Rotation MSpeed	Scaling MSpeed	Position MSpeed
128	Mask Color applies color to mask parameter selection	Red	Green	Blue
129	Edge Fade Color applies color to Edge Fade parameter selection	Red	Green	Blue
130	Mask Color and Edge Fade Color applies the same color to both the selected Mask and Image Edge Fade parameters	Red	Green	Blue
131	Background Color selects background color	Red	Green	Blue
132	Background Color Cycle sequences the background color	Red Speed	Green Speed	Blue Speed
133	Edge Fade Profiles defines edge fading patterns	Selects Mode	Adjusts Profile	Selects Source
134	Collage Generator creates multi-fixture panorama displays, (see <i>Global Functions: Collage Generator™ Effect</i> on page 131)	Selects Array Type	Selects array cell for display	Adjusts Edge blending
135	Curve Correction, Vertical Convex Cylinder corrects shape projecting on curved surface	Adjusts Correction	Sets Vertical Center	Not Used
136	Curve Correction, Vertical Concave Cylinder corrects shape projecting on curved surface	Adjusts Correction	Sets Vertical Center	Not Used
137	Curve Correction, Vertical Inside Corner corrects shape projecting on curved surface	Adjusts Correction	Sets Vertical Center	Sets Horizontal Center
138	Curve Correction, Vertical Outside Corner corrects shape projecting on curved surface	Adjusts Correction	Sets Vertical Center	Sets Horizontal Center
139	Curve Correction, Outside Sphere corrects shape projecting on a sphere's outside surface	Adjusts Correction	Sets Vertical Center	Sets Horizontal Center

DMX Value	Effect Mode Name/Description	Adjustments		
		Modifier 1	Modifier 2	Modifier 3
140	Curve Correction, Inside Sphere corrects shape projecting on a sphere's inside surface	Adjusts Correction	Sets Vertical Center	Sets Horizontal Center
141	Enhanced Collage Generator provides higher resolution for collage arrays larger than 4 x 4.	Selects Array Type	Selects array cell to display	Adjusts Edge blending
142	Spherical Mapping, Outside maps output to a portion of a sphere's outside surface.	Sets Longitude Angle	Sets Latitude Angle	Sets Latitude Center
143	Spherical Mapping, Inside maps output to a portion of a sphere's inside surface.	Sets Longitude Angle	Sets Latitude Angle	Sets Latitude Center
144	Mattes apply provided mattes over image	Matte Effect	Matte Pattern	Texture Source
145	Collage Generator Wrap adds right and left edge blending for 360 degree panoramas	Selects Array Type	Selects array cell to display	Adjusts Edge blending
146	Segmented Collage Generator accepts user defined portion of content for each cell in the grid	Selects Array Type	Selects array cell to display	Adjusts Edge blending
147	Segmented Collage Generator Wrap adds right and left edge blending to the user defined cell content for 360° panoramas	Selects Array Type	Selects array cell to display	Adjusts Edge blending
148	Curved Surface, Horizontal Convex Cylinder corrects shape projecting on curved surface	Adjusts Correction	Sets Horizontal Center	Not Used
149	Curved Surface, Horizontal Concave Cylinder corrects shape projecting on curved surface	Adjusts Correction	Sets Horizontal Center	Not Used
150	Collage Gen 3 provides, updated blend curves for large collage arrays	Selects Array Type	Selects array cell to display	Adjusts Edge blending
151	Collage Gen 3 Wrap provides updated right and left blend curves for 360° panoramas	Selects Array Type	Selects array cell to display	Adjusts Edge blending
152	Segmented Collage Gen 3, improved blending over global effect 146.	Selects Array Type	Selects array cell to display	Adjusts Edge blending
153	Segmented Collage Gen 3 Wrap, improves edge blending over global effect 147.	Selects Array Type	Selects array cell to display	Adjusts Edge blending
223	Modifier used with global spherical mapping effect 142. Defaults to 0 otherwise.	NA	NA	NA
224	Modifier used with global spherical mapping effect 142. Defaults to 0 otherwise.	NA	NA	NA
255	Pan and Scale zooms in and pans across a still image	Horizontal position	Vertical position	Zoom in and out

Global Control

The **Global Control** parameter allows access to different global control modes. How you set the Global control parameter determines the functionality of the **Global Control Modifier** parameter. Setting this parameter to a DMX value of 255 brings up On-screen programming statistics. In this case, the **Global Control Modifier** parameter controls the text color.

Shutdown and Reset Options

When the Global Intensity parameter is set to 0, you can Shutdown the server (DMX Value = 120-130) or Reset the internal Graphics Engine for either DL.3, Axon or DL.2 media servers (DMX Value = 145-149).

On-Screen Statistics

Spherical Control Statistics

When the **Global Control** parameter is set to a DMX value = 252, Spherical Control Statistics are displayed and the **Global Control Modifier** parameter selects text color. page 324.

Performance Statistics

When the **Global Control** parameter DMX value = 254, performance statistics are projected on screen. These are a subset of the statistics shown when **Global Control** = 255.

Statistics displayed are:

- render loops per second
- cpu utilization
- hard disk read
- cue length
- available memory

The **Global Control Modifier** controls the opacity of the of the statistics display background, fading from 0 = opaque to 255 = transparent. Discussion of the global control modifier is on page 325 and should include discussion of background opacity control.

Text Color

When the Global Control parameter is set at a DMX Value of 255, the **Global Control Modifier** parameter lets you choose the text color that will best display over your selected image:

DMX Value	Color
1	Gray
2	Red
3	Blue
4	Green

All-in-One Control Option

When the Global Control parameter is set to a DMX value = 253, you can use the **Global Control Modifier** parameter to control the **All-in-One** control option. This option helps you visualize what the graphics engine is doing. The **All-in-One** option maps the media file content of Collage and Curved Surface support effects as well as up to three effects applied to graphics objects and displays it in a multi-quadrant grid.

These effects are accessed according to rendering hierarchy used by the graphics engine, (see *Graphics Control Hierarchy* on page 56).

When the **Global Control** parameter is set to the All-In-One option, you can view the individual effects applied to each Graphic object in the **Global Control Modifier** parameter.

DMX Value	Global Control Modifier Option (<i>Global Control parameter = 253</i>)	
0	Displays each defined Graphic Object with no effects applied	As the next effect level is displayed, each object displays the highest level of effect applied to that point.
1	Displays the first effect (if any) applied to any defined Graphic Object	
2	Displays the second effect (if any) applied to any defined Graphic Object	
3	Displays the third effect (if any) applied to any defined Graphic Object	
4	Displays the fourth effect (if any) applied to any defined Graphic Object	
5	Displays the fifth effect (if any) applied to any defined Graphic Object	
6	Displays the sixth effect (if any) applied to any defined Graphic Object	
7	Displays the seventh effect (if any) applied to any defined Graphic Object	
8	Displays the eighth effect (if any) applied to any defined Graphic Object	
9	Displays the ninth effect (if any) applied to any defined Graphic Object	

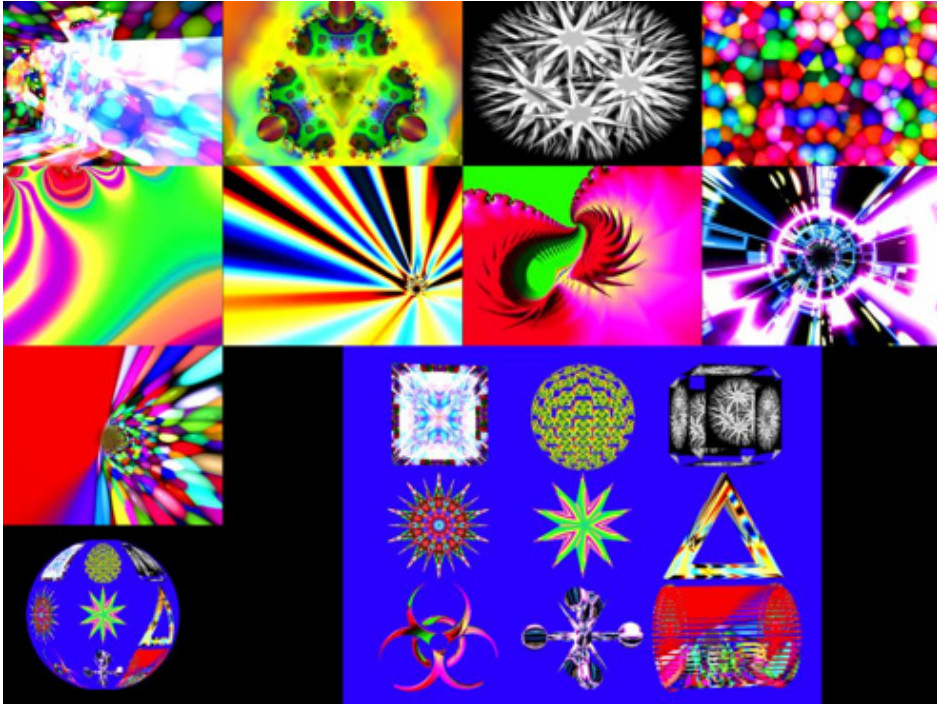

Graphic Object 1	Graphic Object 2	Graphic Object 3	Graphic Object 4
Graphic Object 5	Graphic Object 6	Graphic Object 7	Graphic Object 8
Graphic Object 9	<p style="text-align: center;">Composite Image displaying the object with graphic effects applied</p>		
Spherical Effect or Collage Effect			

Masking Control

Mask Shape Select and Strobing

The **Mask Select** parameter lets you choose a mask to frame or overlay a composite image. You can choose to apply a mask to an image when you don't want an entire image to be seen or you want to transition from an image to black or a solid color without fading intensity.

Mask Shapes

The graphics engine currently provides 30 mask shapes including circular, rectangular, and oval masks that close from inside out or outside in. Checker Board, Radial Wipes, and Multi-panel options are also included with variations.

Default DMX Value = 0 Round "iris" closes from outside in.

DMX values 0-127 (0-50%) are reserved for static mask shapes. Values of 128-255 (51-100%) are reserved for strobing Mask shapes. Values not yet implemented default to 128.

Strobing Mask Shapes

A strobing version of each simple mask shape is defined in the 128-255 (51-100%) DMX value range. When a strobing mask is selected, the strobe rate is controlled by the **Mask Edge**

Fade parameter from the slowest = 0 to the fastest = 255 (100%).

DMX value	Strobe DMX Value	Mask Shapes
0	128	Round <i>iris</i> closing from outside in
1	129	Round <i>iris</i> closing from inside out
2	130	Rectangle closing from outside in
3	131	Rectangle closing from inside out
4	132	Checkerboard, variation 1
5	133	Checkerboard, variation 2
6	134	Radial wipe, variation 1
7	135	Radial wipe, variation 2
8	136	Radial wipe, variation 3
9	137	Radial wipe, variation 4
10	138	Triangles, variation 1
11	139	Triangles, variation 2
12	140	Rectangular wrap
13	141	Tiles closing in
14	142	Horizontal doors, closing
15	143	Horizontal doors closing from opposing sides
16	144	Vertical doors closing from outside in
17	145	Vertical wipe closing from inside out
18	146	Rectangular tiles closing from inside out 1
19	147	Rectangular tiles closing from inside out 2
20	148	Vertical panels closing from outside in 1
21	149	Vertical panels closing from outside in 2
22	150	Vertical diamonds 1
23	151	Vertical diamonds 2
24	152	Horizontal diamonds 1
25	153	Horizontal diamonds 2
26	154	Pinwheel
27	155	Oval Iris closing from outside in
28	156	Oval Iris closing from inside out
29	157	Oscillating iris closing from outside in

NOTE: A *Global Effect Mode* parameter option lets you define a Mask color, (see *Global Effect Mode Channels* on page 112, and *Mask Color* on page 162).

Mask Size

The Mask Size parameter defines mask size for all mask shapes.

Default DMX Value: 255 (100%) = no masking effect

When this parameter is set at a value of 255 (100%), the mask is sized to leave the image 100% visible. When Mask Size is set at 0, the mask totally covers the composite image.

Tip: Crossfading the Mask Size parameter can create unique fades to and from video black.

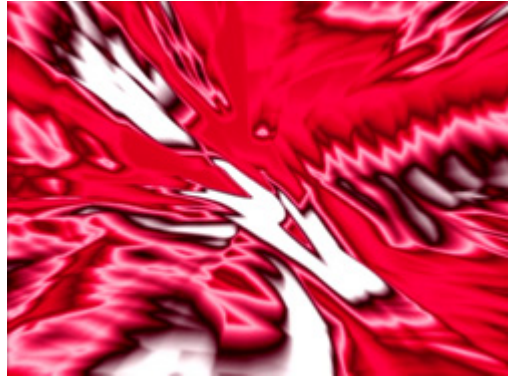

Mask Select DMX value = 0
Mask Size DMX value = 255 (100%)

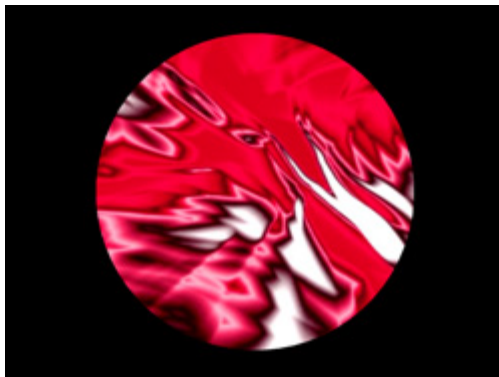

Mask Select value of 0
Mask Size DMX value = 128 (50%)

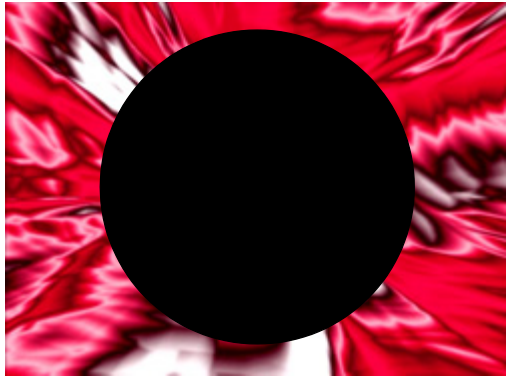

Mask Select DMX value = 1
Mask Size DMX value = 126 (50%)

Mask Edge Fade

The **Mask Edge Fade** parameter operates differently depending on the value of the Mask Select parameter.

Default DMX Value: 0 = no adjustment to mask

When the **Mask Select** parameter value = 0 to 127 (49%), **Mask Edge Fade** adjusts the amount of fading from a DMX value of 0 = no edge fade to 255 (100%)= maximum edge fade.

When the **Mask Select** parameter value = 128 (50%) to 255 (100%), the strobing masks are selected and **Mask Edge Fade** adjusts the speed of the strobing from minimum at a DMX value = 0 to a maximum strobe speed at a DMX value = 255 (100%),

NOTE: *A Global Effect Mode parameter option lets you define a Mask Edge Fade color, (see page 163).*



Original Image



Mask applied without Edge Fade

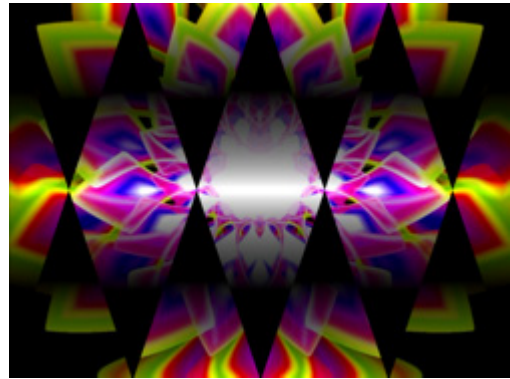

Mask with Edge Fade applied

Image Edge Fade

Four **Image Edge Fade** parameters let you control the Edge Fade for individual sides of your object (top, bottom, left and right). When projecting abutting images, adjusting the Edge Fade parameter lets you smooth the line between two images and also allows you to change an object's boundary.

Default DMX Value: 0 = all edges are sharp and hard.

Adjust each side separately for edge fade from 0 = no fade to 255 (100%) = opaque.



Original Content



100% Top Edge Fade



100% Left Edge Fade



100% Top, Bottom, Left, Right Edge Fade

Keystone Correction Parameters

When you output an image from a projector at an angle, the image may appear skewed. Eight **Keystone** parameters adjust the image shape and compensate for this effect. You can control each of the four corners of the graphics output to reshape your image to a form that projects correctly.

Default DMX Value: 0 = no keystone correction has been applied.

Each corner has an x and a y value that let you adjust and correct the scale of the projection from any corner toward the image center on that axis.

Setting all **Keystone X** and **Y** parameters DMX values to zero will place the four corners of the image at the four corners of the projector output. Adjusting keystone x values toward 255 (100%) moves the respective x corner positions horizontally toward the center of that image edge. Adjusting keystone y values toward 255 (100%) adjusts the respective y corner positions vertically toward the center of that edge of the image.

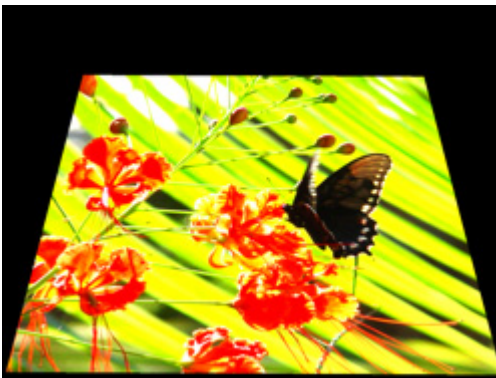
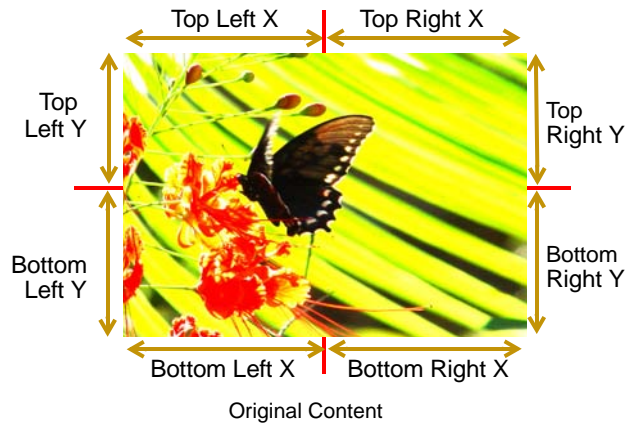

Keystone Top Left X DMX value = 85
Keystone Top Left Y DMX value = 85
Keystone Top Right X DMX value = 85
Keystone Top Right Y DMX value = 85
Other Keystone parameter DMX values = 255

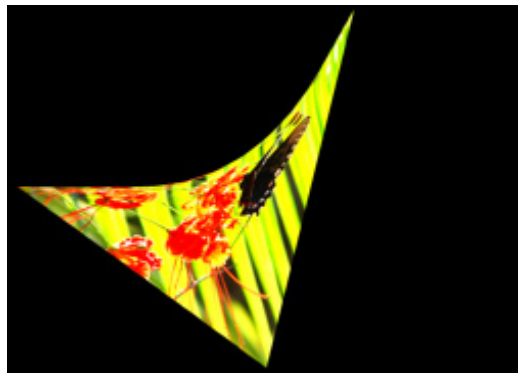

Keystone Top Left Y DMX value = 128
Keystone Top Right X DMX value = 0
Keystone Bottom Left X DMX value = 239
Keystone Bottom Left X DMX value = 0
Keystone Bottom Right Y DMX value = 2
Other Keystone parameter DMX values = 255

NOTE: *DL.3 fixtures have vertical lens shift capability that provides additional keystone control. Engage lens shift with your DMX console in the Control Parameter of the Motion Control fixture type.*

Keystone X Ratio

The **Keystone X Ratio** Parameter shapes the output to adjust for keystone effects created in certain output situations. This parameter adjusts the output by compressing or expanding the image horizontally.

Default DMX Value: 128 (50%) = no adjustment

DMX value settings below the midpoint of the range compress the image horizontally from maximum compression at a value of 0 to no compression at a value of 128. DMX value settings above the midpoint of the range expand the image horizontally from 128 = no expansion to 255 (100%) = maximum expansion.



Original media file



X Ratio DMX value = 255 (100%)

Keystone Y Ratio

The **Keystone Y Ratio** parameter shapes the output to adjust for keystone effects created in certain output situations. This parameter adjusts the output by compressing or expanding the image vertically.

Default DMX Value: 128 (50%) = no adjustment

DMX value settings below the midpoint of the range compress the image vertically from 0 = maximum compression to 255 (100%) = no compression.

DMX value settings above the midpoint of the range expands the image vertically from 128 = no expansion to 255 (100%) = maximum expansion.

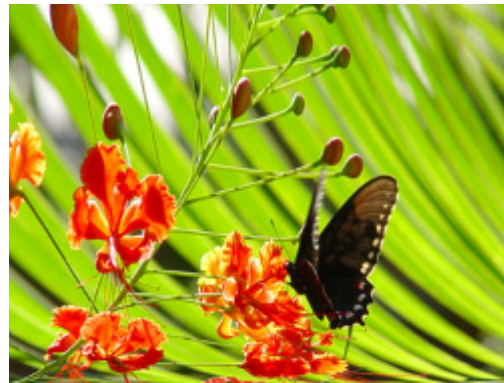

Y Ratio DMX value = 255 (100%)

Framing Parameters

Eight **Framing** parameters allow you to clip an image from each corner in horizontal and vertical directions.

Default DMX Value: 0 = no effect applied.

Each corner has an x and a y value that adjust and correct scale of the projection from any corner toward the image center on that axis.

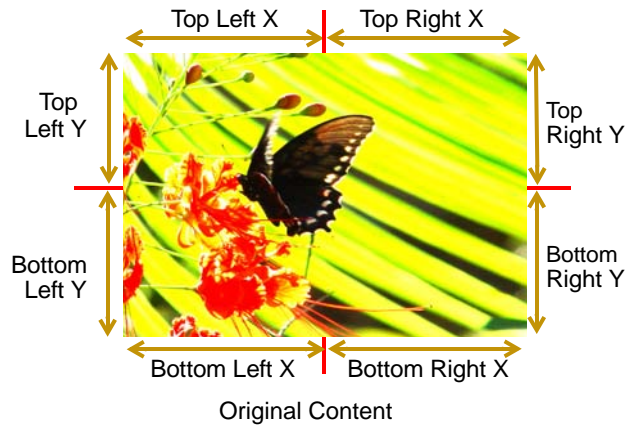

Framing Top Left X DMX value = 8
 Framing Top Left Y DMX value = 31
 Framing Top Right X DMX value = 32
 Framing Bottom Left X DMX value = 23
 Framing Bottom Left X DMX value = 67
 Other Framing parameter DMX values = 0



Framing Top Left X DMX value = 5
 Framing Top Right X DMX value = 188
 Framing Bottom Right X DMX value = 5
 Framing Bottom Left X DMX value = 188
 Other Framing parameter DMX values = 0

Setting all **Framing X** and **Y** parameters DMX values to zero will place the four corners of the image at the four corners of the projector output. Adjusting framing x values across 255 (100%) clips the image from the selected x corner position horizontally toward the image. Adjusting keystone y values toward 255 (100%) clips the image from the selected y corner position vertically across the image.

Global Viewpoint Mode

The **Global Viewpoint Mode** parameter defines a 3-D space and the **Viewpoint Position** parameters modify your *viewing location* with the defined 3-D space. Each Viewpoint Mode uses three values to specify a viewpoint in space. This point in space is specified by the horizontal angle, vertical angle, and zoom.

Within any 3-D space, you can choose the viewpoint target as the center of 3-D space or the center of any defined Graphic Object from 1–9.

Default DMX Value

0 = Perspective view, Spherical Coordinates with the focus at the center of the 3-D space.

Perspective View, Spherical Coordinates

This Viewpoint mode creates a 3-D space with a perspective view of a 3-D space. Viewpoints are located in terms of X, Y and Z positions located on a sphere surrounding the image.

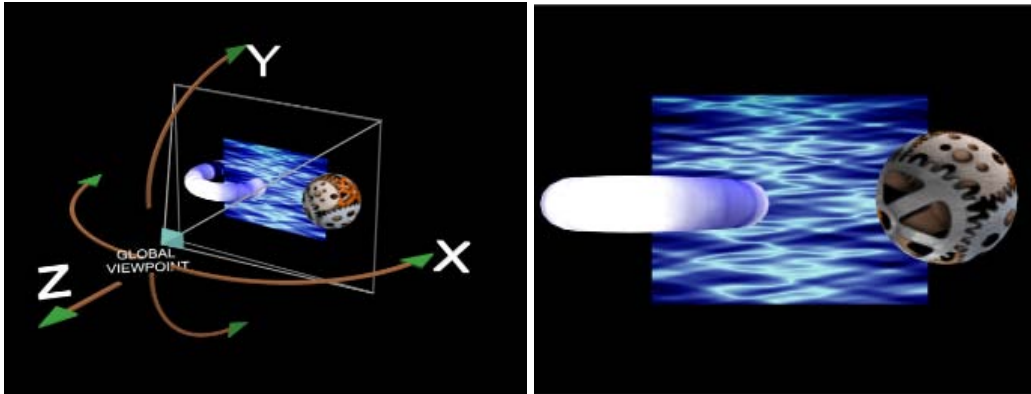

Global Viewpoint set with X, Y, and Z positions all equal to zero.

Output displayed with global viewpoint shown at left.

Perspective View, Cartesian Coordinates

This Viewpoint mode parameter creates a 3-D space with a perspective view. Viewpoints are located in terms of rectangular X, Y and Z positions describing a location in this space.

Orthogonal View, Cartesian Coordinates

This Viewpoint mode creates a 3-D space without perspective. Viewpoint are located in terms of rectangular X, Y and Z positions describing a location in this space. In this case, the composite image is always flat.

Variable Edge Blending

NOTE: Setting the Viewpoint Mode Parameter to a DMX value of 128 accesses the Variable Edge Blending function. This option extends the edge blending range between image components in a Collage. When this option is selected, the Viewpoint Modifier 1 and 2 parameters provide

horizontal and vertical adjustments. For more information on using Variable Edge Blending in conjunction with the Collage Generator Effect, see *Variable Edge Blending* on page 137.

Viewpoint Position X

The **Viewpoint Position X** parameter determines the x component of the viewpoint position to the target you have specified in the Viewpoint Mode parameter. The horizontal angle is the angle around the vertical (y) axis. Heading is another name for this angle.

Default DMX Value: 32768 = center

DMX values above center of the range move counterclockwise to the maximum horizontal angle at a value of 65535 (100%). DMX values below the center move clockwise to the minimum horizontal angle at a value of 0.

Viewpoint Position Y

The **Viewpoint Position Y** parameter sets the vertical angle above/below the horizontal plane. Pitch is another name for this component of the viewpoint position.

Default DMX Value: 32768 = center

DMX values above the center of the range move counterclockwise to the maximum vertical angle at a value of 65535 (100%). DMX values below the center move clockwise to the minimum vertical angle at a value of 0.

Viewpoint Position Z (Zoom)

The **Viewpoint Position Z (Zoom)** parameter is the distance from the view target. Zooming toward the target, you can move through it and view it from the back side creating a mirror image view of the composite object.

Default DMX Value: 30260 = center (This default value is slightly less than midway through the range to maintain some depth to the view of a composite image.)

DMX values above center move toward the maximum distance from origin in back of view target (a DMX value of 65535). DMX values below center move toward the maximum distance from origin in front of view target at a value of zero.

Chapter 12:

Global Functions: Collage Generator™ Effect

Using the Collage Generator™ effect option lets you configure multiple media server outputs to display a single image in arrays up to 16 units horizontal by 8 units vertical.

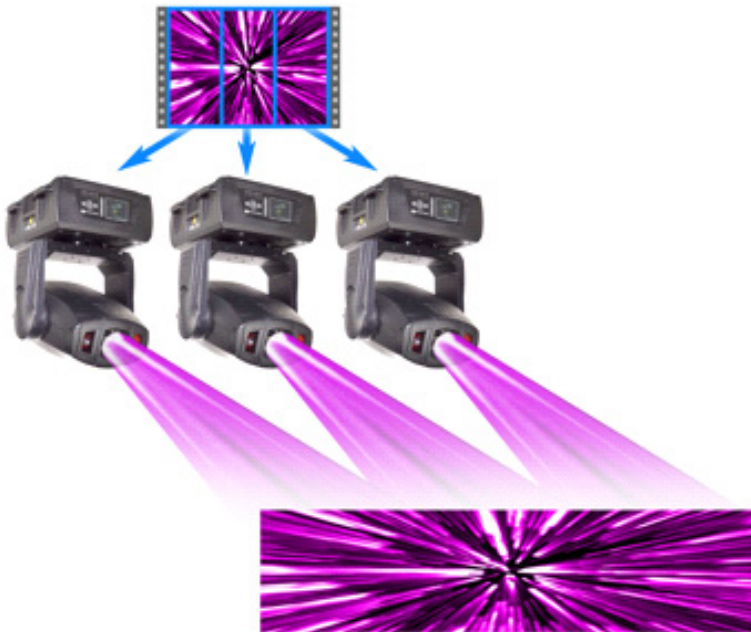

Collage Generator™ technology allows you to create virtually seamless panoramic media projections controlled from your DMX console. You can display either stock or custom content.

You can create a Collage™ effect using DL.3, DL.2 fixtures or Axon media servers outputting to Orbital Head fixtures or other digital projectors.

NOTE: *When using third party projectors, you will need to position output manually.*

The native aspect ratio of one DL.3, DL.2 or Axon media server output is 4:3. Some of the arrays configured in conjunction with the Collage Generator will output a different overall aspect ratio.

NOTE: *You can find other configurations and information on sizing and compressing media to use with the Collage Generator at the High End Systems website (www.highend.com/support/digital_lighting).*

Collage Generator Options

Automated and Segmented Collage Generator options are available in each of the Global Effect parameters. The Collage Generator effect has been continually developed to offer sharper images, and better edge blending. The following table shows the evolution of the effect. Choosing the highest DMX value for the collage option you are using will give you the latest version of the effect.

	Automated Collage Generator Options		Segmented Collage Generator Options	
	Flat Collage	360° Wrap	Flat Collage	360° Wrap
Global Effect DMX Value	134			
	141	145	146	147
	150	151	152	153

Automated Collage Options

The original **Collage Generator** option (selected with a Global Effect DMX value = 134), should only be used with legacy shows. The **Enhanced Collage Generator** option (Global Effect DMX value = 141) provides cleaner images and better edge blending. The **Collage Gen 3** option (DMX value = 150) offers the same image improvements as **Enhanced Collage Generator** and further expands and refines edge blending capability. The images below illustrate the difference in the projected image of a cell from an 8 x 5 grid. The image below on the left shows the projector using the original Collage Generator option and the image on the right shows the improved resolution obtained with the **Enhanced Collage Generator** option.

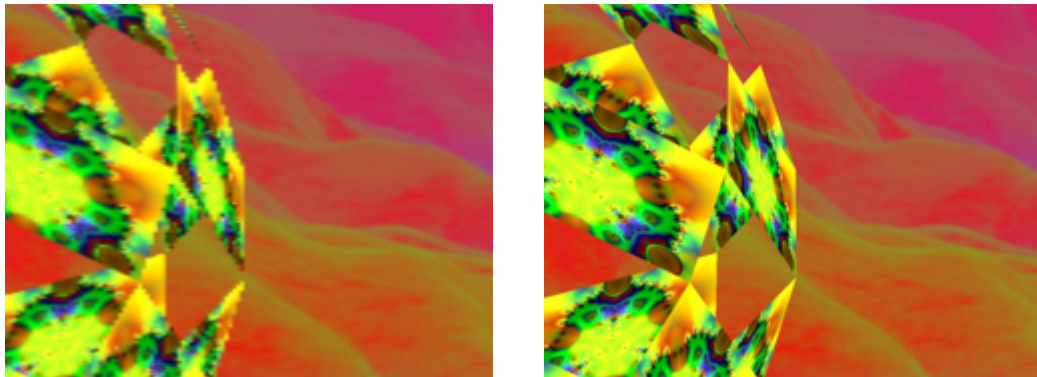

The **Collage Generator Wrap** (DMX value = 145) and **Collage Gen 3 Wrap** (DMX value = 151) options include right and left edge blending that lets you seamlessly project your collage on a 360 degree surface.

NOTE: *In all of the Collage Generator options the content is automatically divided into cell segments by the graphics engine after you define the array size.*

User Segmented Collage Options

In situations where you require extremely high resolution output of custom content, you can select the **Segmented Collage Generator** option (DMX value = 146). Segmented Collage Generator options operate like automated collage option except that content is not automatically divided into cells by the graphics engine. Instead, you configure your collage content for the fixtures before loading it into the server.

Once projected, Segmented Collage options' resolution capabilities are increased many times over that of the automated collage options because the graphics engine is no longer taking a single file and stretching it across multiple servers; but is, instead, showing the file as rendered. Using Segmented Collage options, you can project a 1024x768 file from each server. In addition to the higher resolution, there is less strain on the server since it is not playing back the very large file that would be required with the automated options to get the same high resolution.

NOTE: *The Segmented Collage options only work on 3-D Object #1, which is the 4x3 default rectangle. Custom segmented content will not line up correctly when used on other 3-D objects. If you select a 3-D object other than Object #1, the server will automatically go back to running in Enhanced Collage mode.*

Just as with the Enhanced Collage Wrap, the **Segmented Collage Generator Wrap** option (DMX value = 147) adds right and left edge blending to the user defined cell content for 360 degree panoramas. The **Segmented Collage Gen 3 Wrap** (DMX value = 153) provides improved edge blending.

For more information on developing Segmented Collage content, refer to the Digital Lighting pages at highend.com.

Adjusting the Collage Array with Global Modifier Parameters

The three **Global Effects Mode Modifier** parameters operate as follows:

The **Modifier 1** parameter selects which type of Collage array to use from DMX Values 1-127. The selected size displays in the upper right corner of the grid pattern. A DMX value of 0 = No collage. DMX Values of 126-255 are reserved and default to No collage.

DMX Value	Array (W x H)	DMX Value	Array (W x H)	DMX Value	Array (W x H)	DMX Value	Array (W x H)	DMX Value	Array (W x H)
1	2 x 1	26	1 x 6	51	8 x 2	76	10 x 5	101	13 x 6
2	1 x 2	27	6 x 2	52	2 x 8	77	10 x 6	102	13 x 7
3	2 x 2	28	2 x 6	53	8 x 3	78	10 x 7	103	13 x 8
4	3 x 1	29	6 x 3	54	3 x 8	79	10 x 8	104	14 x 1
5	1 x 3	30	3 x 6	55	8 x 4	80	11 x 1	105	14 x 2
6	3 x 2	31	6 x 4	56	4 x 8	81	11 x 2	106	14 x 3
7	2 x 3	32	4 x 6	57	8 x 5	82	11 x 3	107	14 x 4
8	3 x 3	33	6 x 5	58	5 x 8	83	11 x 4	108	14 x 5
9	4 x 1	34	5 x 6	59	8 x 6	84	11 x 5	109	14 x 6
10	1 x 4	35	6 x 6	60	6 x 8	85	11 x 6	110	14 x 7
11	4 x 2	36	7 x 1	61	8 x 7	86	11 x 7	111	14 x 8
12	2 x 4	37	1 x 7	62	7 x 8	87	11 x 8	112	15 x 1
13	4 x 3	38	7 x 2	63	8 x 8	88	12 x 1	113	15 x 2
14	3 x 4	39	2 x 7	64	9 x 1	89	12 x 2	114	15 x 3
15	4 x 4	40	7 x 3	65	9 x 2	90	12 x 3	115	15 x 4
16	5 x 1	41	3 x 7	66	9 x 3	91	12 x 4	116	15 x 5
17	1 x 5	42	7 x 4	67	9 x 4	92	12 x 5	117	15 x 6
18	5 x 2	43	4 x 7	68	9 x 5	93	12 x 6	118	15 x 7
19	2 x 5	44	7 x 5	69	9 x 6	94	12 x 7	119	15 x 8
20	5 x 3	45	5 x 7	70	9 x 7	95	12 x 8	120	16 x 1
21	3 x 5	46	7 x 6	71	9 x 8	96	13 x 1	121	16 x 2
22	5 x 4	47	6 x 7	72	10 x 1	97	13 x 2	122	16 x 3
23	4 x 5	48	7 x 7	73	10 x 2	98	13 x 3	123	16 x 4
24	5 x 5	49	8 x 1	74	10 x 3	99	13 x 4	124	16 x 5
25	6 x 1	50	1 x 8	75	10 x 4	100	13 x 5	125	16 x 6
								126	16 x 7
								127	16 x 8

The **Modifier 2** channel selects which cell of the grid a particular DL.3 or DL.2 fixture will display. DMX values 0 up to 127 are used to step through grid pattern you selected with the Modifier 1 channel. As you dial through Modifier 2, the selected cell in the grid is highlighted.

DMX values of 128-255 default to the upper left corner of the grid.

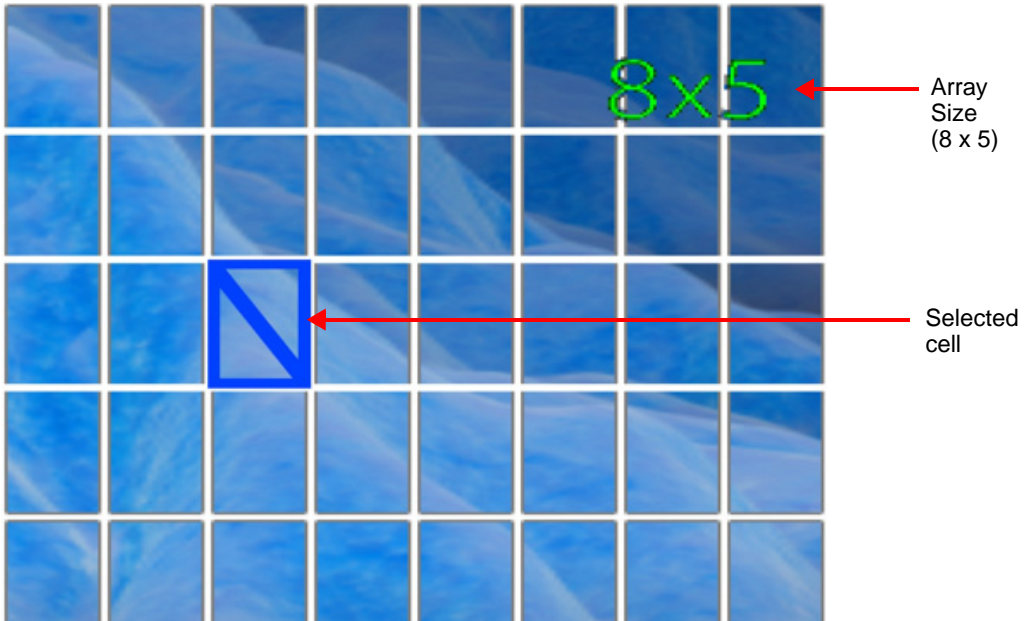

Selecting any value larger than the number of grid rectangles defined by Modifier 1 or values from 128-255 defaults to the top-left rectangular area of the grid.

The **Modifier 3** channel lets you manually or automatically control the blended edges of the adjacent projections. You can also display grid overlays that show your Modifier 1 and Modifier 2 channel selections.

	Action
0	No blend adjustment
1-63	Progressively darkens the blend regions
64	No blend adjustment
65-127	Progressively brightens the blend regions.
128-143	Displays rectangular area with no blending
144	Selects a blend curve optimized for color content
145	Selects a blend curve optimized for grayscale content
146-160	Selects the default blend curve
161-191	Displays rectangular area with no blending covering full projector output
192-199	Displays default alignment pattern in rectangular area without blend area
200-207	Displays default alignment pattern with blending
208-215	Displays default alignment pattern and blend area with no blending
216-255	Displays collage selection grid over selected image/movie.

Collage Setup Example

Here's a typical scenario for setting up a 2 x 2 central panorama collage effect.

NOTE: *If you are going to be mapping your Collage to a sphere, you will need to roughly adjust the output before you set up the Collage, (see Spherical Mapping Setup Guide on page 138).*

Setup the Collage effect:

1. Select the same content on four media servers.

NOTE: *Any parameter adjustment to a graphic object must be set on ALL graphic objects that are a part of the Collage. For example, if you are configuring Graphic Object 1 on four media servers to project as a Collage and want to apply a color effect, that effect must be manipulated on Graphic Object 1 of all four media servers.*

2. On all the media servers you are configuring, set a **Global Effect Mode** channel to a DMX value of 150 to select the Collage Gen 3 option.

TIP: *For the most reliable performance, use the same Global Effect Mode parameter on all the Graphic objects to set up the Collage effect. This also leaves the other Global Effect Mode parameter available for adding a second effect like spherical mapping to the composite image.*

3. On all the media servers you are configuring, set **Modifier 1** DMX value = 1 to activate the array options. *The selection grid will not appear until the first modifier is set above 0*
4. On all the media servers you are configuring, set **Modifier 3** DMX value = 255 (100%) to display the selection grid.
5. On all the media servers you are configuring, increase **Modifier 1** to a value between 1 and 127 to select a Collage array configuration.
6. On each individual server, set **Modifier 2** DMX value between 1-127 (the range depending on the value selected in Step 5) to select which grid cell that media server will project.
7. Use **Position**, **Keystone** and **Ratio** parameters to align the projections of the individual media servers in such a way that there is some overlap between the separate portions of the image. This overlap is needed for blending adjustment.
8. Set **Modifier 3** to a DMX value between 192 and 199 to define a hard edge for alignment. Readjust Position, Keystone and Ratio parameters to bring Collage elements into good alignment.
9. Increase the **Modifier 3** DMX value = 203-207 to blend the overlap between the outputs. Readjust Position, Keystone and Ratio parameters to bring Collage elements to fine tune alignment.

10. On all the media servers you are configuring, set the **Global Effect Mode Modifier 3** parameter to a DMX value to the default range of 0-127 (with edge blending) or between 128-143 (without edge blending) to put the media server output into their cropped Collaged state. The choice between the two values will depend on your preference for aligning the images.

Execute the panorama Collage:

1. Create a setup cue that identifies the content media file and folder, sets the Play Mode parameter to *Pause and Rewind to In Frame* (DMX = 5) and the Opacity to 0 for the same graphic object on all units you are configuring for the panorama.
2. For this example, follow with a cue that sets the Play Mode parameter of *Play Loop Forward* (DMX = 0) and brings up the Opacity to 100% for the same graphic object on all units you are configuring for the panorama.

Variable Edge Blending

Variable Edge Blending is used in conjunction with any of the Collage Generator Modes and allows for on-the-fly adjustment of blend overlap between projectors. Using this mode gives more flexibility for sizing a collage to a given screen or projection surface, as well as smoother blending if wider blend regions are used.

The **Variable Edge Blend** adjustment allows for blend region adjustments from 0% (hard edge) up to 50% of the image size. Horizontal and vertical blend regions can be controlled independently of one another.

Variable Edge Blend is turned on by setting the **Viewpoint Mode** parameter to a value of 128. When variable edge blend is used, the view point mode will default to spherical universe and cannot be changed. The view point position modifiers then become the modifiers used for adjustment of the blend region sizes.

When active, the **Viewpoint** modifiers function as follows:

Modifier 1 (Viewpoint X Position): Horizontal blend width adjustment (Vertical Edges) from 0 = no adjustment to 255 = a maximum overlap of 50%.

Modifier 2 (Viewpoint Y Position): Vertical blend width adjustment (Horizontal Edges) from 0 = no adjustment to 255 = a maximum overlap of 50%.

Modifier 3 (View Point Z Position): Not used.

Because both Modifier 1 and Modifier 2 default to 32768 when they are used as Viewpoint Position modifiers, they will default to the same when Variable Edge Blend is activated. With this value, the blend regions are set to approximately 25% overlap.

NOTE: *When Variable Edge Blend is used, all of the servers in the collage must be set to the same vertical and horizontal blend overlap values. If this is not done, the collage will not align properly.*

Setting up Variable Edge Blending:

1. Select one of the collage modes available in the Global Effects
2. Using the collage modifiers, select the collage size for your application, and assign each unit its place in the collage
3. Set the Viewpoint Mode channel to a value of 128. This will activate the Variable Edge Blending
4. Using the Viewpoint Position X and Y modifiers, adjust the blend region width to the desired value. All units in the collage must have the same X and Y values or the collage will not align properly.
5. Align the collage using the keystone parameters, (see *Keystone Correction Parameters* on page 125).

Mapping a Collage to a Spherical Surface

The Spherical Mapping effect takes the normal rectangular output and wraps it on a selected portion of a sphere. This is the same as wrapping a flat map on to a globe. The horizontal position of a point is its longitude. The vertical position of a point is its latitude. For a detailed description of this effect, see *Spherical Mapping* on page 227.

Adjusting the Spherical Mapping effect requires a total of nine modifier parameters. Selecting Spherical Mapping along with a Collage Generator effect uses the available Global Effects. In addition to the three Global Effects Modifier parameters associated with the Spherical Mapping selection, six modifier parameters are accessed by setting any Global or Graphic Effect Mode parameters to a DMX value of 253 or 254. Any available effect mode from any Graphic Object can be used. The Effects Mode parameters used do not have to be from the same Graphic Object. One of these parameters enables the Effects Mode Modifiers to control the vertical position of the projector (actually the graphics viewpoint), the vertical position of the sphere and a vertical size. The other Effect Mode selection provides Modifier parameters to control the amount of vertical bend in horizontal lines, the vertical center of the added bend, and horizontal size.

Spherical Mapping Setup Guide

Before You Begin

Successful spherical mapping requires careful positioning of the DL.3, DL.2 units or Axon-controlled projectors you are using. Units should be mounted at equal angles from each other and the same distance from the sphere. Mounting units at the same height will minimize the tilt angle adjustments you will need to make.

Mapping Two Outputs to a Sphere

The following example describes mapping two outputs on a sphere, with each covering half of the surface. For best results, make each adjustment to both outputs as you follow the example. After you've completed the following steps, you can more easily transfer the DMX values to the outputs for other cells of the Collage.

Select a Global Effect and two Graphic Effects to control Spherical Mapping:

1. Set **Global Effect** channel to a DMX value = 142 to select the Spherical Mapping option. Set the three associated **Global Effect Modifier** parameters to their default values (Modifier 1=0, Modifier 2=0, Modifier 3 = 128).
2. Select the Spherical Mapping Control 1 option (DMX = 253) in any available **Graphic Effect Mode** channel. Set the three associated Effect Modifiers to their default DMX values (Modifier 1 = 128, Modifier 2 = 128, Modifier 3 = 64).
3. Select the Spherical Mapping Control 2 option (DMX value = 254) on any available **Graphic Effect Mode** channel. Set all associated Effect Modifiers to their default DMX values. (Modifier 1 = 0, Modifier 2 = 128, Modifier 3 = 64)
4. In the **Global Control** channel, select the on-screen statistics for the spherical mapping option (DMX value = 252). Use the **Global Control Modifier** to select text color for easier viewing.
5. Select the 4 x 3 (Flat Plane) option in the **3-D Object** channel (DMX = 1).
6. Select the HES Set Up and Test option in the **Media Folder** channel (DMX = 39), and Test Grid.jpg in the **File Folder** (DMX = 9).

At this point, you should be viewing the two projected grids with statistics displayed. If you do not see an output, check that all **Modifier** parameters are set to their default values.

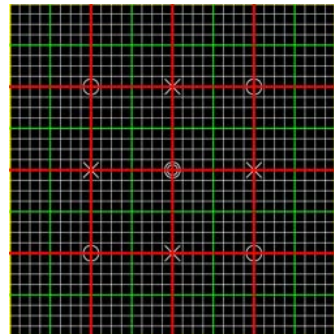

TIP: Before you begin other adjustments, physically view the grid from along the centerline of the fixture. The centerline of the grid should align with the center of the sphere. You can easily adjust any variation using the Pan channel. The object is to align the vertical lines of the guide with the vertical axis of the sphere.

Adjust output positioning on the sphere:

7. Use **Global Effect Modifier 2** to adjust the latitude angle. You can view the Latitude top and Latitude bottom statistics to see the degrees of spread + or – from the “equator”.
8. Use **Global Effect Modifiers 3** to move the output up or down to the part of the sphere you want to cover. The Latitude top and Latitude bottom statistics show you the center of adjustment in degrees + or – from the “equator”.
9. Adjust the **Global Effect Modifier 1** to set the longitude angle.

Make viewpoint adjustments:

10. On the **Graphic Effect Mode** channel set to Spherical Control 1 (DMX = 253), use **Modifier 1** to move the center of the grid to the center of the output marked by the double circles around the crossed lines. This adjusts vertical offset to accommodate the projector's position. The default value assumes a viewpoint straight on to the "equator". **Modifier 2** adjusts the sphere's offset to compensate for projector head tilt.

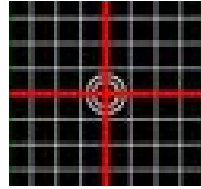

NOTE: After completing a rough adjustment, you will use these two modifier channels for the fine tuning.

11. Use **Modifier 3** to adjust the vertical size of the output, stretching and compressing it to adjust for the size of the sphere, keeping the vertical size of the grid filling the output without clipping the image.

Correct for the flat to round surface distortions

12. On any of the **Global** or **Graphic Effect Mode** channels set to Spherical Control 2 (DMX = 254), and then use the associated **Modifier 3** to compress the grid edges adjusting the bend in horizontal grid lines. This adjustment should not be used to fill the projector output horizontally. Instead, it should be used in conjunction with the Spherical Mapping Global Effect Modifier 1 to control the longitude angle of the projected image. Global Effect Modifier 1 should be maintained close to the theoretical longitude angle.
13. Use **Modifier 1** and **Modifier 2** to adjust the amount of bend, up or down, in the horizontal lines of the grid. **Modifier 1** controls amount of correction. **Modifier 2** controls where the center of correction occurs.
14. If the spherical mapping effect is being used in conjunction with the Collage Generator effect, select the Enhanced Collage Generator option (DMX = 141) in the other **Global Effect** channel now. Set the appropriate grid size and grid elements selected with the internal Collage alignment grid enabled. Go back through steps 1 through 11. Remember that pan and tilt adjustments are also available when using a DL.3 or DL.2 fixture.

Now you have a rough adjustment of the spherical mapping effect. From this point, finely adjust all the parameters until you bring the output to the desired shape.

When fine tuning Spherical Mapping adjustments, remember the following:

- The Graphic Object effect 253 Modifiers 1 and 2 have a major influence on the shape of the vertical lines.
- The Spherical Mapping Global Effect modifiers can be used to provide fine control of the shape of the vertical lines, but should be within several degrees of the expected latitude and longitude values.
- The Graphic Object effect 253 Modifiers 1 and 2 are used to finely adjust the vertical bend in horizontal lines.

Spherical Mapping Tips

- If the fixtures are arranged symmetrically around the sphere, the adjustment made to the various control Modifiers of Global and Graphic Spherical Mapping effects will be the same or nearly the same when the fine tuning is complete. You can save time by selecting the Modifier on all the fixtures you are using for the Collage and making each adjustment on all the fixtures together.
- Projector Pan, Tilt, and Zoom also affect alignment.
- Don't make small changes until the alignment is roughed in.
- When alignment doesn't seem to be working, record and store your current settings, then go back to the default values and begin again.
- The longitude angle is the angle between fixtures from the vertical axis of the sphere and should be defined in your lighting plot. The plot should also give you a good idea of the latitude angle. The final values and those theoretical values should be close.

Creating Custom Content for the Collage Generator Effect

There are two main steps to process HD footage into DL.3, DL.2 and Axon compliant media for use with the Collage Generator.

First, acquire or commission High-resolution media footage or stills. In most cases, scaling and cropping of the media is a simple process. However, certain types of media such as footage of people or round objects like planets may require more sophisticated cropping and scaling to optimize display in certain aspect ratios.

Then, save your media at Photo jpeg 95% or a non compressed format (these can be very large files) to use as a master file. Or, if you are an intermediate video editor yourself, there are many Video editing packages that will allow you to size and optimize the master for your application.

Once the master file is created, you will need high-definition encoder software.

For more information on creating Digital Lighting content and selecting encoder software, see *Custom User Content* on page 347 or go to www.highend.com/support/digital_lighting.

Collages Using Live S-Video and SDI Input

DL.3, Axon and DL.2 media servers can create Collage arrays using live S-Video or SDI input. All the media servers used to project a Collage need to be receiving the same source input signal to use video as a Collage feed.

For example, using DL.3 Camera outputting across a 2 x 2 20-K lumen Central Panorama Collage, four DL.3 fixtures are assigned an output from the SDI-DMX Mixer Pro to each SDI input and a fifth DL.3 fixture is used as the source.

NOTE: *These features are not available in the DL.3F model*

Chapter 13:

Effect Mode Options Descriptions

Effects can be applied to the Media File content (texture) mapped onto a 3-D object. Multiple Color and Geometric effects are available in Effect Mode parameters for both individual Graphic object and Global control.

Most of the effect options you will find described in this chapter are available for **Effects Mode** parameters at both the graphic control level for each Graphic Object and global control level for the composite image. The following pages describe all the **Effect Mode** options available along with a description of how each **Modifier** parameter functions with that mode selected. Options are arranged alphabetically and grouped as Color or Geometric Effects.

Check boxes in the upper right hand corner indicate **Object Effect** **Global Effect** whether this mode is available as a Graphic Object Effect, a Global Effect or both.

Because the options for all **Effect Mode** parameters are identical, you can apply up to three effects at the graphic level and another five effects at the global level. This lets you choose, for example, whether to apply a color effect to an individual object or to the composite image at the global level.

After you select a mode using either a **Graphic Object Effect Mode** or a **Global Effect Mode** parameter, you can use the three associated Modifier parameters to adjust the effect. The behavior of the Modifier parameters depends upon the selected effect.

- For a general information on Graphics Control features, see *Graphics Engine Overview* on page 55.
- For a table of Graphic Effects, see *Effect Mode Parameters* on page 102.
- For a table of Global Effects, see *Global Effect Mode Channels* on page 112.

NOTE: *Both Object and Global Effect parameters include effects for swapping colors to provide quick color conversions. Use the following DMX Values in any of the Effect parameters to make these color conversions.*

DMX Value	Color Component Conversion Effect		
7	Red Blue	Green → Red	Blue → Green
8	Red → Green	Green → Blue	Blue → Red
17	Red → Cyan	Green → Magenta	Blue → Yellow
18	Red → Magenta	Green → Yellow	Blue → Cyan
19	Red → Yellow	Green → Cyan	Blue → Magenta
41	Red → Blue	Green → Green	Blue → Red
42	Red → Red	Green → Blue	Blue → Green
43	Red → Green	Green → Red	Blue → Blue

Effect Mode Color Options

All or Nothing

Object Effect Global Effect

Effect Mode parameter DMX value = 15

This effect reduces all color values to full saturation or no color based on comparison to a set threshold. This effect creates an image with fully saturated color.

Modifier 1: Compares the red component of a pixel to the threshold value and converts it to full color if it is greater than the threshold and to black if it is below the threshold.

Modifier 2: Compares the green component of a pixel to the threshold value and converts it to full color if it is greater than the threshold and to black if it is below the threshold.

Modifier 3: Compares the blue component of a pixel to the threshold value and converts it to full color if it is greater than the threshold and to black if it is below the threshold.



Original Content

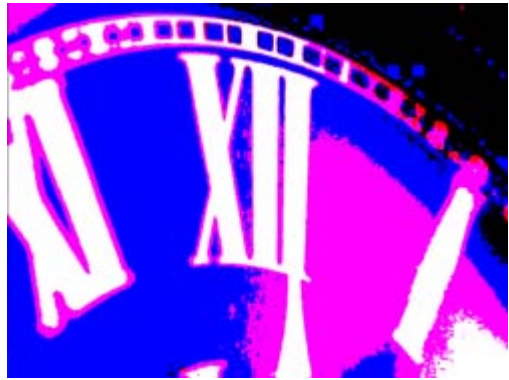

Modifier 1 parameter DMX = 125

Modifier 2 parameter DMX = 140

Modifier 3 parameter DMX = 10

Background Color

Object Effect Global Effect

Effect Mode parameter DMX value = 131

There is a default black background behind every composite image. You cannot rotate, scale or position the background and it is visible from every viewpoint and position. This effect allows you to apply color to the background. This background color will not affect any of the Graphic Object effects selected.

Modifier 1: Defines the red color component from DMX values of 0 = no red to 255 (100%) = maximum red saturation.

Modifier 2: Defines the green color component from DMX values of 0 = no green to 255 (100%) = maximum green saturation.

Modifier 3: Defines the blue color component from DMX values of 0 = no blue to 255 (100%) = maximum blue saturation.

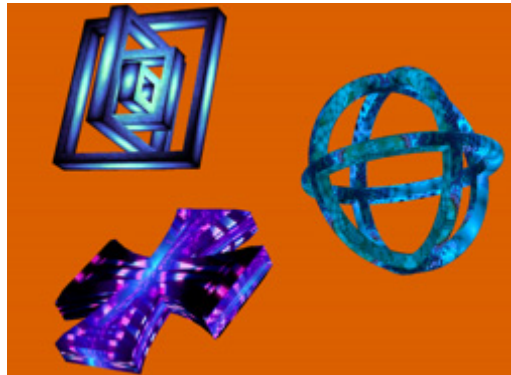

Modifier 1 parameter DMX = 220

Modifier 2 parameter DMX = 97

Modifier 3 parameter DMX = 0

Background Color Cycle

Object Effect Global Effect

Effect Mode parameter DMX value = 132

There is a background behind every composite image. You cannot rotate, scale or position the background and it is visible from every viewpoint and position. This effect allows you to cycle a color sequence on the background controlling the transition speed.

Modifier 1: Defines the red color component speed. A DMX value of 128 (50%) = default cycle speed. DMX Values above the midpoint increase cycle speed in a forward direction to 255 (100%) = fastest change speed. DMX values below the midpoint increase cycle speed in a backward direction to 0 = fastest change speed.

Modifier 2: Defines the green color component speed. A DMX value of 128 (50%) = default cycle speed. DMX Values above the midpoint increase cycle speed in a forward direction to 255 (100%) = fastest change speed. DMX values below the midpoint increase cycle speed in a backward direction to 0 = fastest change speed.

Modifier 3: Defines the blue color component speed. A DMX value of 128 (50%) = default cycle speed. DMX Values above the midpoint increase cycle speed in a forward direction to 255 (100%) = fastest change speed. DMX values below the midpoint increase cycle speed in a backward direction to 0 = fastest change speed.

CMY

Object Effect Global Effect

Effect Mode parameter DMX value = 1

This parameter simulates CMY color by inverting RGB color components. Use this parameter when you want to color mix with a CMY color model instead of RGB color model.

Modifier 1: Increases cyan color component from 0 = no adjustment to 255 (100%) = maximum cyan saturation.

Modifier 2: Increases magenta color component from 0 = no adjustment to 255 (100%) = maximum magenta saturation.

Modifier 3: Increases yellow color component from 0 = no adjustment to 255 (100%) = maximum yellow saturation.



Original Content

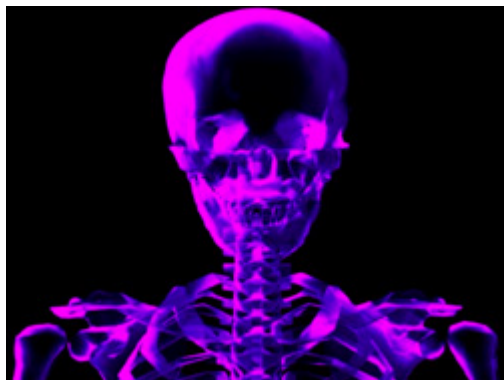

Modifier 1 parameter DMX = 0
Modifier 2 parameter DMX = 255
Modifier 3 parameter DMX = 0

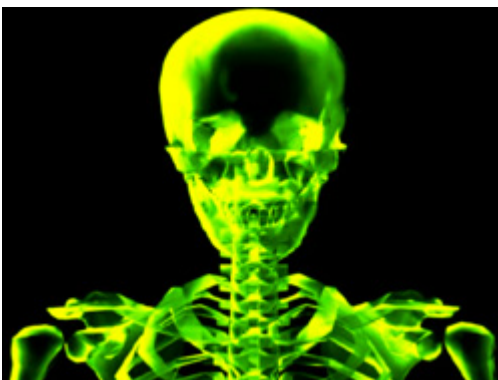

Modifier 1 parameter DMX = 0
Modifier 2 parameter DMX = 0
Modifier 3 parameter DMX = 255



Modifier 1 parameter DMX = 255
Modifier 2 parameter DMX = 255
Modifier 3 parameter DMX = 0

CMY Add All Pixels

Object Effect Global Effect

Effect Mode parameter DMX value = 2

This effect increases color values across all pixels including black pixels.

Modifier 1: Increases cyan color component from 0 = no adjustment to 255 (100%) = maximum cyan saturation.

Modifier 2: Increases magenta color component from 0 = no adjustment to 255 (100%) = maximum magenta saturation.

Modifier 3: Increases yellow color component from 0 = no adjustment to 255 (100%) = maximum yellow saturation.



Original Content



Modifier 1 parameter DMX = 255

Modifier 2 parameter DMX = 0

Modifier 3 parameter DMX = 0



Modifier 1 parameter DMX = 0

Modifier 2 parameter DMX = 255

Modifier 3 parameter DMX = 0



Modifier 1 parameter DMX = 0

Modifier 2 parameter DMX = 0

Modifier 3 parameter DMX = 255

CMY Add Non-black Pixels

Object Effect Global Effect

Effect Mode parameter DMX value = 3

This effect increases color values across all pixels except black pixels.

Modifier 1: Increases cyan color component from 0 = no adjustment to 255 (100%) = maximum cyan saturation.

Modifier 2: Increases magenta color component from 0 = no adjustment to 255 (100%) = maximum magenta saturation.

Modifier 3: Increases yellow color component from 0 = no adjustment to 255 (100%) = maximum yellow saturation.



Original Content



Modifier 1 parameter DMX = 255

Modifier 2 parameter DMX = 0

Modifier 3 parameter DMX = 0



Modifier 1 parameter DMX = 0

Modifier 2 parameter DMX = 255

Modifier 3 parameter DMX = 0



Modifier 1 parameter DMX = 0

Modifier 2 parameter DMX = 0

Modifier 3 parameter DMX = 255

Color Cycle

Object Effect Global Effect

Effect Mode parameter DMX value = 14

The image's color components cycle through RGB, black, and white. When no Red Green or Blue is added, image fades from full white, to normal image, to black. When RGB/CMY is added the image fades from the RGB value, to the image with color added.

Modifier 1: Increases red color component from 0 = no adjustment to 255 (100%) = maximum red saturation.

Modifier 2: Increases green color component from 0 = no adjustment to 255 (100%) = maximum green saturation.

Modifier 3: Increases blue color component from 0 = no adjustment to 255 (100%) = maximum blue saturation.

Color DeConverge

Object Effect Global Effect

Effect Mode parameter DMX value = 39

This effect separates the different color components of an image and offsets them from the original image position.

Modifier 1: Moves the image's red component up from 0= no adjustment to 255 (100%) = maximum distance from original position.

Modifier 2: Moves the image's green component down and right from 0= no adjustment to 255 (100%) = maximum adjustment.

Modifier 3: Moves the image's blue component down and left from 0 = no adjustment to 255 (100%) = maximum blue saturation.

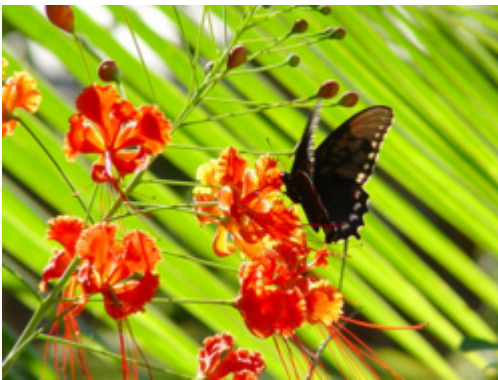

Original Content

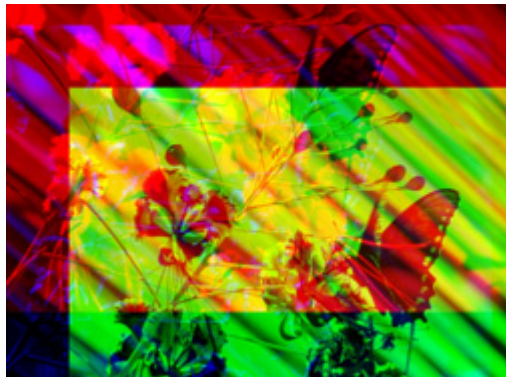

Modifier 1 parameter DMX = 211

Modifier 2 parameter DMX = 255

Modifier 3 parameter DMX = 67

Colorize Gray Scale

Object Effect Global Effect

Effect Mode parameter DMX value = 44

This effect maps a selected pixel intensity to a selected color scheme. A variety of color schemes simulate effects like thermography. This is especially effective effect when applied to input from the internal camera.

Modifier 1: Selects from color schemes along a range of values from 0 – 255.

Modifier 2: Sets the zero point of the color intensity level from 0 = no intensity to 255 (100%) = maximum intensity.

Modifier 3: Fades from original color scheme to new color scheme using selected intensity.

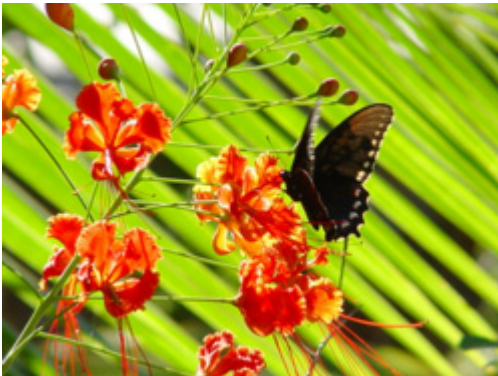

Original Content

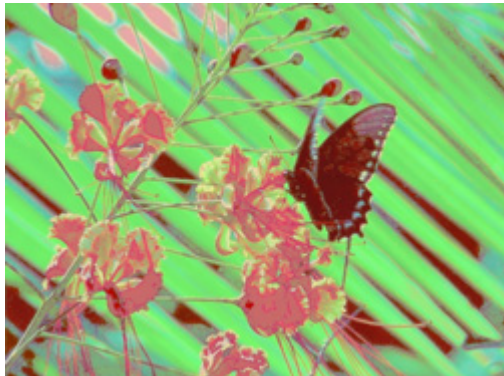

Modifier 1 parameter DMX = 125

Modifier 2 parameter DMX = 200

Modifier 3 parameter DMX = 100

Color to Alpha

Object Effect Global Effect

Effect Mode parameter DMX value = 49

This parameter varies the transparency level of an image's component color values.

Modifier 1: Increases the red component opacity or intensity from 0 = no adjustment to 255 (100%) = full red opacity (intensity).

Modifier 2: Increases the green component opacity or intensity from 0 = no adjustment to 255 (100%) = full green opacity (intensity).

Modifier 3: Increases the blue component opacity or intensity from 0 = no adjustment to 255 (100%) = full blue opacity (intensity).

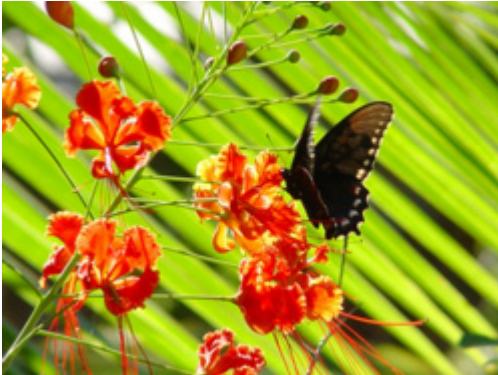

Original Content



Original Content



Modifier 1 parameter DMX = 60

Modifier 2 parameter DMX = 75

Modifier 3 parameter DMX = 240

Color to Alpha, Inverted

Object Effect Global Effect

Effect Mode parameter DMX value = 50

This parameter varies the transparency level of the inverse of an image's component color values.

Modifier 1: Increases the inverse red component opacity or intensity from 0 = no adjustment to 255 (100%) = full green and blue opacity (intensity).

Modifier 2: Increases the green component opacity or intensity from 0 = no adjustment to 255 (100%) = full red and blue opacity (intensity).

Modifier 3: Increases the blue component opacity or intensity from 0 = no adjustment to 255 (100%) = full red and green opacity (intensity).

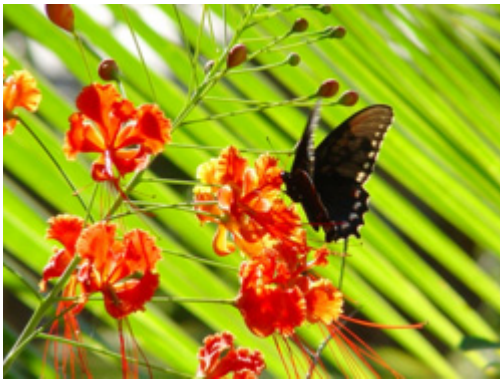

Object 1 Original Content



Object 2 Original Content

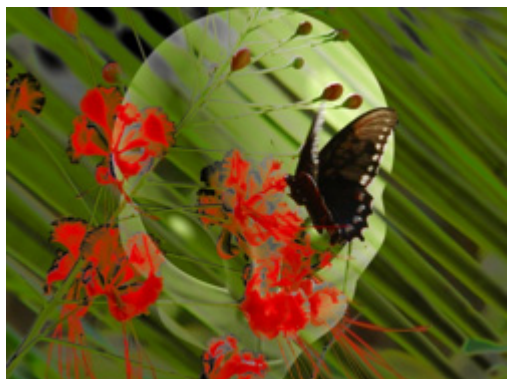

Modifier 1 parameter DMX = 145

Modifier 2 parameter DMX = 215

Modifier 3 parameter DMX = 15

DotP and Resample

Object Effect Global Effect

Effect Mode parameter DMX value = 13

This effect applies an algorithm that pixelates, and solarizes the image. It also makes the surface of some 3D objects appear reflective.

Modifiers 1, Modifier 2 and Modifier 3 parameters work together to adjust the algorithm.



Original Content

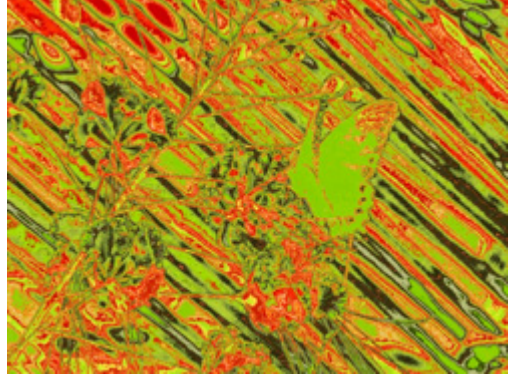

Modifier 1 parameter DMX = 170

Modifier 2 parameter DMX = 64

Modifier 3 parameter DMX = 168

Edge Detect Black and White

Object Effect Global Effect

Effect Mode parameter DMX value = 21

This effect displays only the edges of image components. Edges appear white, everything else is black.

Modifier 1: Adjusts horizontal edge search size from 0= no adjustment to 255 (100%) = maximum adjustment.

Modifier 2: Adjusts vertical edge search size from 0= no adjustment to 255 (100%) = maximum adjustment.

Modifier 3: Adjusts comparison edge threshold from 0= no adjustment to 255 (100%) = maximum adjustment.

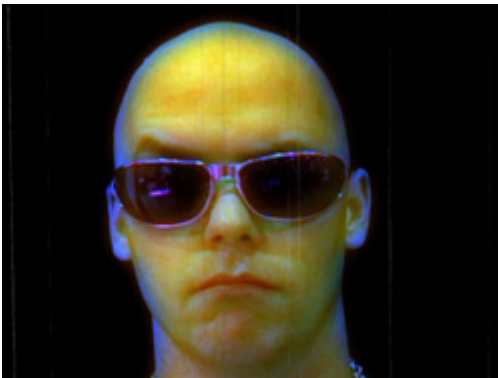

Original Content



Modifier 1 parameter DMX value = 184

Modifier 2 parameter DMX value = 114

Modifier 3 parameter DMX value = 62

Edge Detect Black and White 2

Object Effect Global Effect

Effect Mode parameter DMX value = 92

This effect displays only the edges of image components as either black or white.

Modifier 1: Adjusts sample distance from 0= no adjustment to 255 (100%) = maximum adjustment.

Modifier 2: Adjusts comparison edge threshold from 0= no adjustment to 255 (100%) = maximum adjustment:

Modifier 3: Sets the detected edge scaler, 0 - 127 = white edge on black background, 128-255 = black edge on white background.

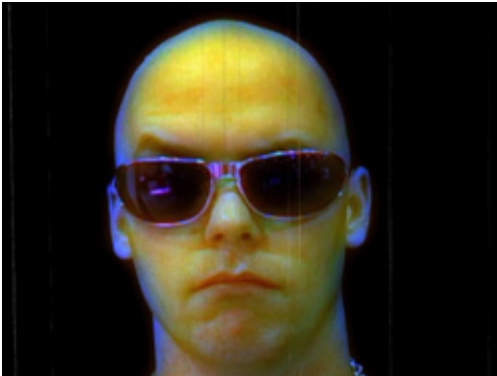

Original Content



Modifier 1 parameter DMX value = 155

Modifier 2 parameter DMX value = 40

Modifier 3 parameter DMX value = 129

Edge Detect Color

Object Effect Global Effect

Effect Mode parameter DMX value = 20

This effect displays only the edges of image components with their color values.

Modifier 1: Adjusts horizontal edge search size from 0= no adjustment to 255 (100%) = maximum adjustment.

Modifier 2: Adjusts vertical edge search size from 0= no adjustment to 255 (100%) = maximum adjustment.

Modifier 3: Adjusts comparison edge threshold from 0= no adjustment to 255 (100%) = maximum adjustment.

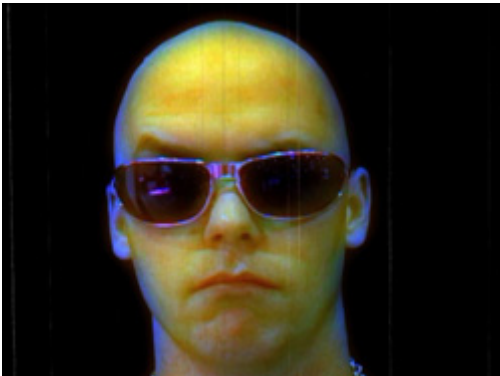

Original Content

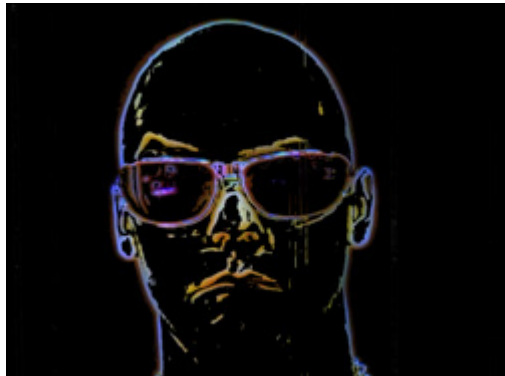

Modifier 1 parameter DMX = 184

Modifier 2 parameter DMX = 114

Modifier 3 parameter DMX = 62

Edge Fade Color

Object Effect Global Effect

Effect Mode parameter DMX value = 129

This effect applies color to a selected **Edge Fade** parameter, (see *Image Edge Fade* on page 124).

Modifier 1: Increases red color component from 0 = no adjustment to 255 (100%) = maximum red saturation.

Modifier 2: Increases blue color component from 0 = no adjustment to 255 (100%) = maximum blue saturation.

Modifier 3: Increases green color component from 0 = no adjustment to 255 (100%) = maximum green saturation.

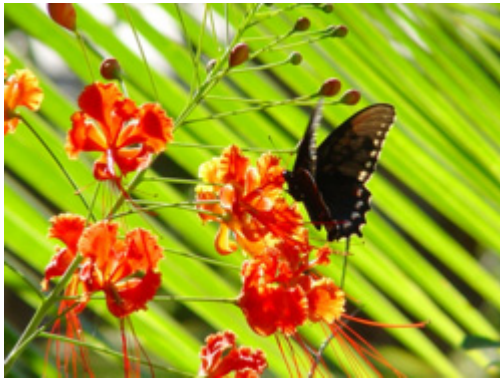

Original Content



Original Content with Edge Fade effect applied



Modifier 1 parameter DMX = 143

Modifier 2 parameter DMX = 100

Modifier 3 parameter DMX = 25

Glow

Object Effect Global Effect

Effect Mode parameter DMX value = 73

Glow colorizes and creates a glow on the 3-D object separate from the media texture on it. You can apply this effect to any 3-D object no matter which media file texture is applied to it. This parameter provides an option to view a 3-D object without displaying the associated texture.

Modifier 1: Increases red color component from a DMX value of 0 = no adjustment to 255 (100%) = maximum red saturation.

Modifier 2: Increases blue color component from a DMX value of 0 = no adjustment to 255 (100%) = maximum blue saturation.

Modifier 3: Increases green color component from a DMX value of 0 = no adjustment to 255 (100%) = maximum green saturation.



Original Content



Modifier 1 parameter DMX = 0
Modifier 2 parameter DMX = 221
Modifier 3 parameter DMX = 168

Glow Color Cycle

Object Effect Global Effect

Effect Mode parameter DMX value = 74

Glow colorizes and creates a glow on the 3-D object separate from the media texture on it. You can apply this effect to any 3-D object no matter which media file texture is applied to it. This parameter provides an option to view a 3-D object without an associated texture.

Modifier 1: Defines the red color component speed. A DMX value of 128 (50%) = default cycle speed. DMX Values above the midpoint increase cycle speed in a forward direction to 255 (100%) = fastest change speed. DMX values below the midpoint increase cycle speed in a backward direction to 0 = fastest change speed.

Modifier 2: Defines the green color component speed in the same way as Modifier 1.

Modifier 3: Defines the blue color component speed in the same way as Modifier 1.

HS Effect Mode Options

Object Effect Global Effect

These Object and Global effects map the media file to an HSI color space. This makes it easier to isolate a specific feature in an image such as an individual flower in a landscape.



Object 1 Content

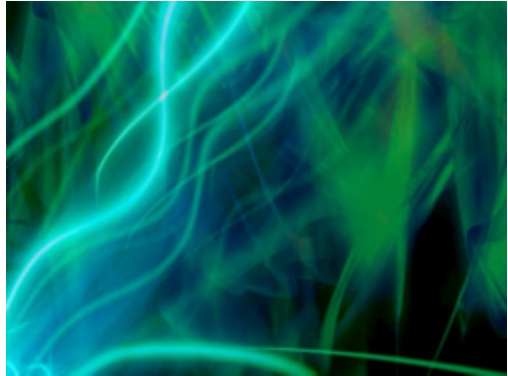

Object 2 Background Content

HS to Gray

Effect Mode parameter DMX value = 87

This effect Maps a selected color coordinate to an HSI color space and turns everything else gray.

Modifier 1: Adjusts the **Hue** color component from 0 = no adjustment to 255 (100%) = maximum red saturation.

Modifier 2: Adjusts the **Saturation** color component from 0 = no adjustment to 255 (100%) = maximum green saturation.

Modifier 3: Adjusts the color tolerance from 0 = minimum to 255 (100%) = maximum



Effect Mode parameter = 87

Modifier 1 parameter DMX = 0

Modifier 2 parameter DMX = 0

Modifier 3 parameter DMX = 222

HS Selected to Transparent

Effect Mode parameter DMX value = 89

Maps a selected color coordinate to a HSI color space and turns it transparent and shows graphic objects “behind” it. Everything else is unchanged.

Modifier 1: Adjusts the **Hue** color component from 0 = no adjustment to 255 (100%) = maximum red saturation.

Modifier 2: Adjusts the **Saturation** color component from 0 = no adjustment to 255 (100%) = maximum green saturation.

Modifier 3: Adjusts the color tolerance from 0 = minimum to 255 (100%) = maximum



Effect Mode Parameter = 89
Modifier 1 parameter DMX = 0
Modifier 2 parameter DMX = 38
Modifier 3 parameter DMX = 255

HS to Transparent

Effect Mode parameter DMX value = 88

Maps a selected color coordinate to a HSI color space and turns everything else transparent and shows graphic objects “behind” it.

Modifier 1: Adjusts the **Hue** color component from 0 = no adjustment to 255 (100%) = maximum red saturation.

Modifier 2: Adjusts the **Saturation** color component from 0 = no adjustment to 255 (100%) = maximum green saturation.

Modifier 3: Adjusts the color tolerance from 0 = minimum to 255 (100%) = maximum



Effect Mode Parameter = 88
Modifier 1 parameter DMX = 0
Modifier 2 parameter DMX = 38
Modifier 3 parameter DMX = 255

Intensity Key

Object Effect Global Effect

Effect Mode parameter DMX value = 45

This effect turns pixels of a selected intensity transparent or applies the reverse effect.

Modifier 1: Selects intensity from a DMX value of 0 = no intensity to 255 (100%) = full intensity.

Modifier 2: Selects intensity bandwidth from a DMX value of 0 = narrowest bandwidth to 255 = widest bandwidth.

Modifier 3: Turns selected intensity range transparent from 0 = no change to 128 = fully transparent. DMX values above the midpoint of the range change all intensities outside of the selected range transparent from 129 = no transparency to 255 = full reverse transparency.

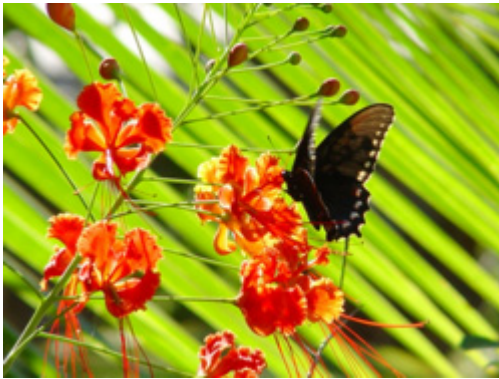

Original Content



Modifier 1 parameter DMX = 30
Modifier 2 parameter DMX = 75
Modifier 3 parameter DMX = 168

Mask Color

Object Effect Global Effect

Effect Mode parameter DMX value = 128

This effect applies color to a selected mask shape

Modifier 1: Increases red color component from a DMX value of 0 = no adjustment to 255 (100%) = maximum red saturation.

Modifier 2: Increases blue color component from a DMX value of 0 = no adjustment to 255 (100%) = maximum blue saturation.

Modifier 3: Increases green color component from a DMX value of 0 = no adjustment to 255 (100%) = maximum green saturation.

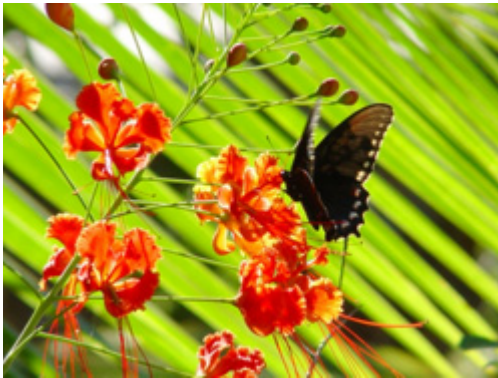

Original Content



Effect Mode Parameter = 128



Modifier 1 parameter DMX = 47

Modifier 2 parameter DMX = 0

Modifier 3 parameter DMX = 127

Mask Color and Edge Fade Color

Object Effect Global Effect

Effect Mode parameter DMX value = 130

This effect applies a color to both the selected Mask shape and any selected Edge parameter. Color can also be applied to Mask shape (see *Particle System* on page 212) and Edge parameter(s) separately.

Modifier 1: Increases red color component from a DMX value of 0 = no adjustment to 255 (100%) = maximum red saturation.

Modifier 2: Increases blue color component from a DMX value of 0 = no adjustment to 255 (100%) = maximum blue saturation.

Modifier 3: Increases green color component from a DMX value of 0 = no adjustment to 255 (100%) = maximum green saturation.

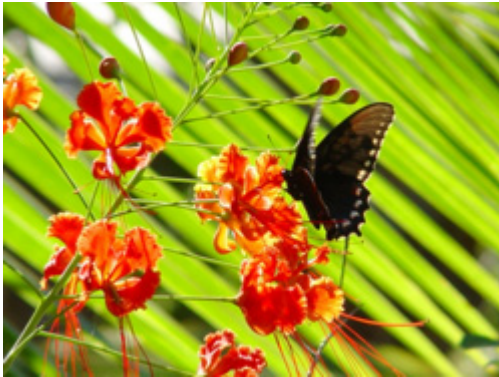

Original Content

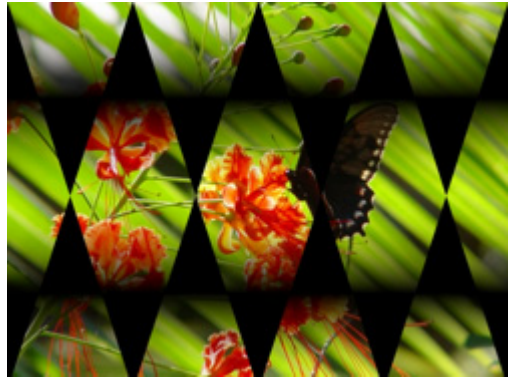

Original Content with Mask Color and Edge Fade Color effect applied



Modifier 1 parameter DMX = 89

Modifier 2 parameter DMX = 0

Modifier 3 parameter DMX = 112

RGB Add, All Pixels

Object Effect Global Effect

Effect Mode parameter DMX value = 4

This effect adds color to all pixels including black using the RGB color model.

Modifier 1: Increases red color component from a DMX value of 0 = no adjustment to 255 (100%) = maximum red saturation.

Modifier 2: Increases blue color component from a DMX value of 0 = no adjustment to 255 (100%) = maximum blue saturation.

Modifier 3: Increases green color component from a DMX value of 0 = no adjustment to 255 (100%) = maximum green saturation.

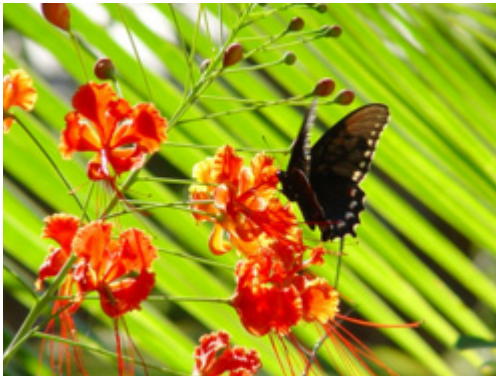

Original Content



Modifier 1 parameter DMX = 255

Modifier 2 parameter DMX = 56

Modifier 3 parameter DMX = 122

RGB Add2, All Pixels

Object Effect Global Effect

Effect Mode parameter DMX value = 5

This effect adds color to all pixels including black using an alternate RGB color algorithm.

Modifier 1: Increases red color component from a DMX value of 0 = no adjustment to 255 (100%) = maximum red saturation.

Modifier 2: Increases blue color component from a DMX value of 0 = no adjustment to 255 (100%) = maximum blue saturation.

Modifier 3: Increases green color component from a DMX value of 0 = no adjustment to 255 (100%) = maximum green saturation.

RGB Add to Non-black Pixels

Object Effect Global Effect

Effect Mode parameter DMX value = 6

This effect adds color to all pixels except black using the RGB color model.

Modifier 1: Increases red color component from a DMX value of 0 = no adjustment to 255 (100%) = maximum red saturation.

Modifier 2: Increases blue color component from a DMX value of 0 = no adjustment to 255 (100%) = maximum blue saturation.

Modifier 3: Increases green color component from a DMX value of 0 = no adjustment to 255 (100%) = maximum green saturation.

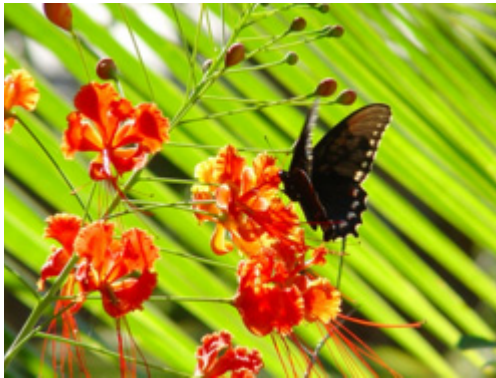

Original Content

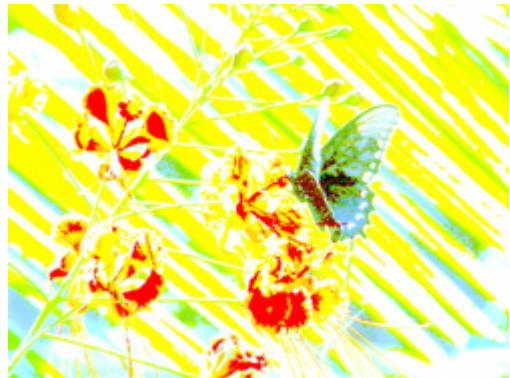

Modifier 1 parameter DMX = 114

Modifier 2 parameter DMX = 185

Modifier 3 parameter DMX = 255

RGB Invert

Object Effect Global Effect

Effect Mode parameter DMX value = 17

This effect inverts color values to transition the image from an RGB to a CMY color model.

Modifier 1: Transitions the red component from no adjustment at a DMX value = 0 to cyan at a value of 255 (100%)

Modifier 2: Transitions the green component from no adjustment at a DMX value = 0 to magenta at a value of 255 (100%)

Modifier 3: Transitions the blue component from no adjustment at a DMX value = 0 to yellow at a value of 255 (100%)

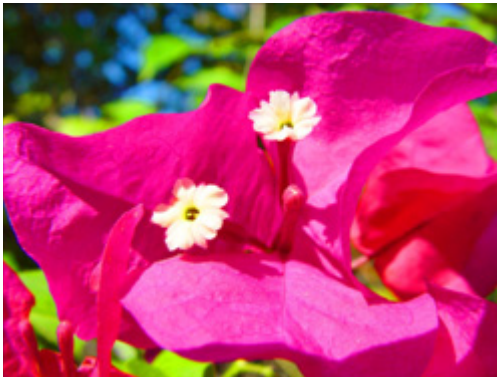

Original Content

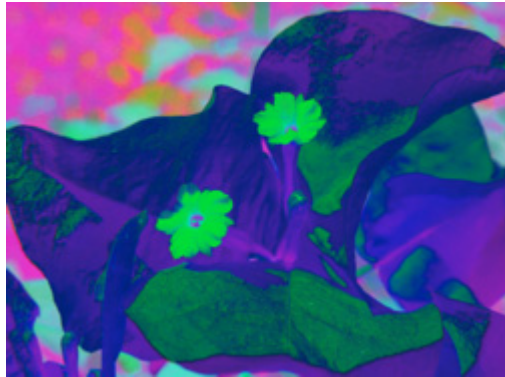

Modifier 1 parameter DMX = 255

Modifier 2 parameter DMX = 34

Modifier 3 parameter DMX = 203

RGB Invert and Swap to BRG

Object Effect Global Effect

Effect Mode parameter DMX value = 19

This effect swaps the color values from RGB to an inverted BRG color model.

Modifier 1: Transitions the red component from no adjustment at a value of 0 to yellow at a value of 255 (100%)

Modifier 2: Transitions the green component from no adjustment at a value of 0 to cyan at a value of 255 (100%)

Modifier 3: Transitions the blue component from no adjustment at a value of 0 to magenta at a value of 255 (100%).



Original Content



Modifier 1 parameter DMX = 255

Modifier 2 parameter DMX = 34

Modifier 3 parameter DMX = 203

RGB Invert and Swap to GBR

Object Effect Global Effect

Effect Mode parameter DMX value = 18

This effect swaps the color values from RGB to an inverted GBR color model.

Modifier 1: Transitions the red component from no adjustment at a DMX value = 0 to magenta at a value of 255 (100%)

Modifier 2: Transitions the green component from no adjustment at a DMX value = 0 to yellow at a value of 255 (100%)

Modifier 3: Transitions the blue component from no adjustment at DMX value = 0 to cyan at a value = 255 (100%)



Original Content



Modifier 1 parameter DMX = 255

Modifier 2 parameter DMX = 34

Modifier 3 parameter DMX = 203

RGB Scale

Object Effect Global Effect

Effect Mode parameter DMX value = 47

Reduce and increase color components in the image as a part of the overall color range.

NOTE: the maximum of Mod1, Mod2 and Mod3 sets overall color range.

Modifier 1: Scales Red in the Media file. A DMX Value of 128 = no adjustment. DMX values below 128 (50%) reduce color value. DMX values over 128 increase color value.

Modifier 2: Scales Green in the Media file. A DMX Value of 128 = no adjustment. DMX values below 128 (50%) reduce color value. DMX values over 128 increase color value.

Modifier 3: Scales Blue in the Media file. A DMX Value of 128 = no adjustment. DMX values below 128 (50%) reduce color value. DMX values over 128 increase color value.

RGB Swap to BGR

Object Effect Global Effect

Effect Mode parameter DMX value = 41

This effect allows you to swap colors. All red values become green and all blue values become red. Green values are unaffected.

Modifier 1: Transitions red color component to blue from 0 = no color change to 255 (100%) = green

Modifier 2: No change to green color component

Modifier 3: Transitions blue color component to green from 0 = no color change to 255 (100%) = red



Original Content



Modifier 1 parameter DMX = 255

Modifier 2 parameter DMX = 192

Modifier 3 parameter DMX = 255

RGB Swap to BRG

Object Effect Global Effect

Effect Mode parameter DMX value = 8

This effect allows you to swap colors. All red values become blue, all green values become red and all blue values become green.

Modifier 1: Transitions red color component to blue from 0 = no color change to 255 (100%) = blue

Modifier 2: Transitions green color component to red from 0 = no color change to 255 (100%) = red

Modifier 3: Transitions blue color component to green from 0 = no color change to 255 (100%) = green

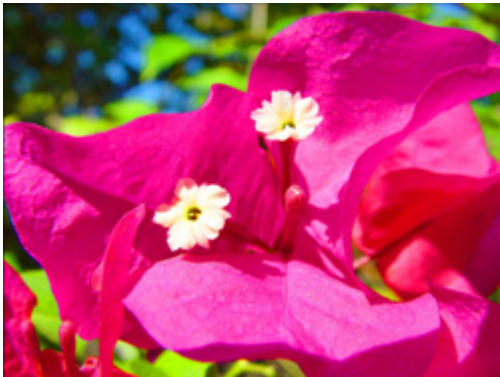

Original Content



Modifier 1 parameter DMX = 255

Modifier 2 parameter DMX = 192

Modifier 3 parameter DMX = 255

RGB Swap to GBR

Object Effect Global Effect

Effect Mode parameter DMX value = 7

This effect allows you to swap colors. All red values become green, all green values become blue and all blue values become red.

Modifier 1: Transitions red color component to green from 0 = no color change to 255 (100%) = green

Modifier 2: Transitions green color component to blue from 0 = no color change to 255 (100%) = blue

Modifier 3: Transitions blue color component to red from 0 = no color change to 255 (100%) = red



Original Content



Modifier 1 parameter DMX = 255

Modifier 2 parameter DMX = 192

Modifier 3 parameter DMX = 255

RGB Swap to GRB

Object Effect Global Effect

Effect Mode parameter DMX value = 43

This effect allows you to swap colors. All red values become green and all green values become blue. Blue values are unaffected.

Modifier 1: Transitions red color component to green from 0 = no color change to 255 (100%) = green

Modifier 2: Transitions green color component to red from 0 = no color change to 255 (100%) = blue

Modifier 3: No change to blue color component



Original Content



Modifier 1 parameter DMX = 255

Modifier 2 parameter DMX = 192

Modifier 3 parameter DMX = 255

RGB Swap to RBG

Object Effect Global Effect

Effect Mode parameter DMX value = 42

This effect allows you to swap colors. All green values become blue and all blue values become green. Red values are unaffected.

Modifier 1: No change to red color component

Modifier 2: Transitions green color component to blue from 0 = no color change to 255 (100%) = blue

Modifier 3: Transitions blue color component to green from 0 = no color change to 255 (100%) = red

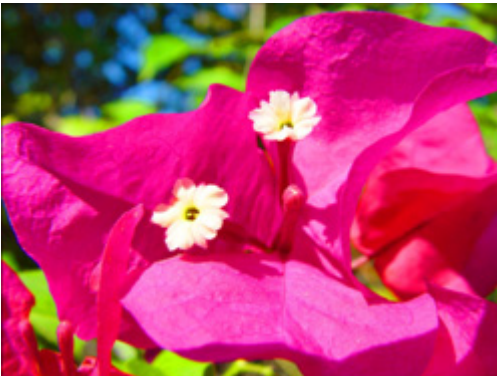

Original Content



Modifier 1 parameter DMX = 255

Modifier 2 parameter DMX = 192

Modifier 3 parameter DMX = 255

Scan Line

Object Effect Global Effect

Effect Mode parameter DMX value = 32

Maps image color intensities to the colors in a single horizontal line of the selected texture.

Modifier 1: Selects a line of the media file to scan

Modifier 2: Adjusts the mapping transition

Modifier 3: Not used

Sharpen

Object Effect Global Effect

Effect Mode parameter DMX value = 82

Manipulates edges of image components to sharpen contrast between them.

Modifier 1: Selects a sample distance from a minimum at a DMX value = 0 to a maximum at a DMX value = 255

Modifier 2: Selects the number of filter passes from a minimum at a DMX value = 0 to a maximum at a DMX value = 255

Modifier 3: Selects the scale sharpen coefficients at DMX values from 0-255

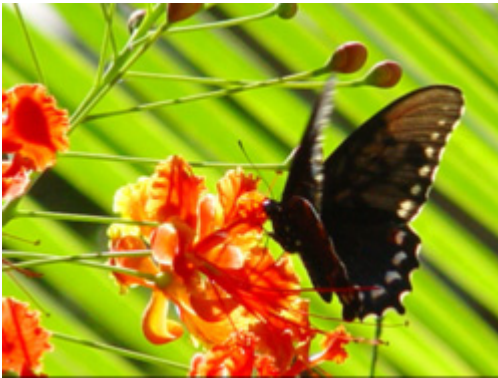

Original Content

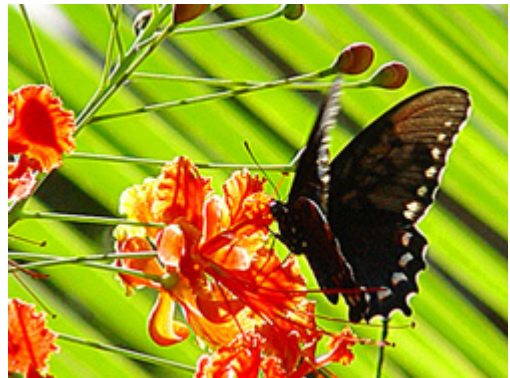

Modifier 1 parameter DMX = 128

Modifier 2 parameter DMX = 0

Modifier 3 parameter DMX = 0



Modifier 1 parameter DMX = 128

Modifier 2 parameter DMX = 30

Modifier 3 parameter DMX = 0



Modifier 1 parameter DMX = 128

Modifier 2 parameter DMX = 30

Modifier 3 parameter DMX = 128

Solarize

Object Effect Global Effect

Each of the Solarize effects remaps colors to a narrow value range and inverts the color below a set threshold using different algorithms. Solarize effects can create strong highlights.

Modifier 1: Increases red color component from 0 = no adjustment to 255 (100%) = maximum red saturation. Red color values below the threshold are converted to cyan.

Modifier 2: Increases blue color component from 0 = no adjustment to 255 (100%) = maximum blue saturation. Blue color values below the threshold are converted to magenta.

Modifier 3: Increases green color component from 0 = no adjustment to 255 (100%) = maximum green saturation. Green color values below the threshold are converted to yellow.

Solarize I

Effect Mode parameter DMX value = 9



Original Content



Original Content with **Effect Mode** = 9



Modifier 1 parameter DMX = 170

Modifier 2 parameter DMX = 137

Modifier 3 parameter DMX = 232

Solarize 2

Effect Mode parameter DMX value = 10



Original Content

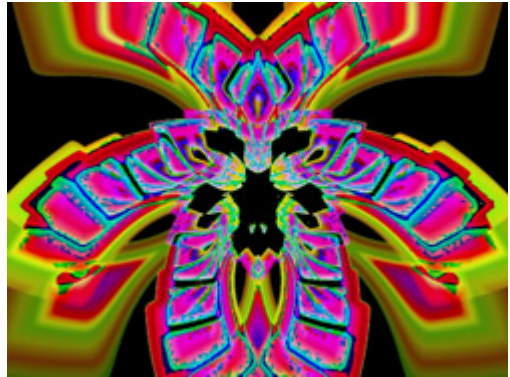

Original Content with **Effect Mode** = 10



Modifier 1 parameter DMX = 212

Modifier 2 parameter DMX = 255

Modifier 3 parameter DMX = 208

Solarize 3

Effect Mode parameter DMX value = 11

Solarize 4

Effect Mode parameter DMX value = 12

Solid Color RGB

Object Effect Global Effect

Effect Mode parameter DMX value = 16

Solid Color RGB removes the media file texture and allows you to color mix the 3-D object to one solid color

Modifier 1: Increases red color component from 0 = no adjustment to 255 (100%) = maximum red saturation.

Modifier 2: Increases green color component from 0 = no adjustment to 255 (100%) = maximum green saturation.

Modifier 3: Increases blue color component from 0 = no adjustment to 255 (100%) = maximum blue saturation.

Transparent Color

Object Effect Global Effect

These effects remove a color (or small color range) from one graphic image to reveal another “behind” it. The removed color becomes transparent. Modifier parameters define the color you want to select as the transparent color in terms of Red, Green and Blue values set in the Modifier parameters.

Modifier 1: Defines the red color component from DMX values of 0 = no red to 255 (100%) = maximum red saturation.

Modifier 2: Defines the green color component from DMX values of 0 = no green to 255 (100%) = maximum green saturation.

Modifier 3: Defines the blue color component from DMX values of 0 = no blue to 255 (100%) = maximum blue saturation.

Transparent Color Coarse

Effect Mode parameter DMX value = 28

The Transparent Color Coarse parameter selects a color range $\pm 40\%$ either side of the defined value.

Transparent Color Fine

Effect Mode parameter DMX value = 26

The Transparent Color Fine parameter selects a color range $\pm 15\%$ either side of the defined value.

Transparent Color Medium

Effect Mode parameter DMX value = 27

The Transparent Color Medium parameter selects a color range $\pm 25\%$ either side of the defined value.

Transparent Color, Invert

Object Effect Global Effect

These effects remove a color (or small color range) from one graphic image to reveal another “behind” it. The removed color becomes transparent. The modifier parameters define the color you want to select as the transparent color in terms of Red, Green and Blue values. An Inverted Transparent Color effect selects a color range either side of the defined value and then sets every other color as transparent.

Modifier 1: Defines the red color component from 0 = no red to 255 (100%) = maximum red saturation.

Modifier 2: Defines the green color component from 0 = no green to 255 (100%) = maximum green saturation.

Modifier 3: Defines the blue color component from 0 = no blue to 255 (100%) = maximum blue saturation.

Transparent Color Invert, Coarse

Effect Mode parameter DMX value = 31

The Transparent Color Invert, Coarse effect selects a color range $\pm 40\%$ either side of the defined value.

Transparent Color Invert, Medium

Effect Mode parameter DMX value = 30

The Transparent Color Invert, Medium effect selects a color range $\pm 25\%$ either side of the defined value.

Transparent Color Invert, Fine

Effect Mode parameter DMX value = 29

The Transparent Color Invert, Fine effect selects a color range $\pm 15\%$ either side of the defined value.

UV Effect Mode Options

Object Effect Global Effect

These Object and Global effects map the media file to an YUV color space. This makes it easier to isolate a specific feature in an image such as an individual flower in a landscape.



Graphic Object 1 Content



Graphic Object 2 Background Content

UV to Gray

Effect Mode parameter DMX value = 84

Maps a selected color coordinate to a YUV color space and turns everything else gray.

Modifier 1: Adjusts the U color component from 0 = no adjustment to 255 (100%) = maximum red saturation.

Modifier 2: Adjusts the V color component from 0 = no adjustment to 255 (100%) = maximum green saturation.

Modifier 3: Adjusts the color tolerance from 0 = minimum to 255 (100%) = maximum.



Modifier 1 parameter DMX = 0

Modifier 2 parameter DMX = 229

Modifier 3 parameter DMX = 101

UV Selected to Transparent

Effect Mode parameter DMX value = 86

Maps a selected color coordinate to a YUV color space and turns it transparent. Everything else is unchanged.

Modifier 1: Adjusts the U color component from 0 = no adjustment to 255 (100%) = maximum red saturation.

Modifier 2: Adjusts the V color component from 0 = no adjustment to 255 (100%) = maximum green saturation.

Modifier 3: Adjusts the color tolerance from 0 = minimum to 255 (100%) = maximum.



Modifier 1 parameter DMX = 0

Modifier 2 parameter DMX = 229

Modifier 3 parameter DMX = 101

UV to Transparent

Effect Mode parameter DMX value = 85

Maps a selected color coordinate to a YUV color space and turns everything else transparent.

Modifier 1: Adjusts the U color component from 0 = no adjustment to 255 (100%) = maximum red saturation.

Modifier 2: Adjusts the V color component from 0 = no adjustment to 255 (100%) = maximum green saturation.

Modifier 3: Adjusts the color tolerance from 0 = minimum to 255 (100%) = maximum.



Modifier 1 parameter DMX = 0

Modifier 2 parameter DMX = 229

Modifier 3 parameter DMX = 101

Yxy Luminance Scaling

Object Effect Global Effect

Effect Mode parameter DMX value = 101

Mapping the image to a Luminance Chrominance color space allows brightness adjustment without changing image color.

Modifier 1: Scales luminance. Values below the midpoint decrease luminance from 127 to 0 = black. Settings above the midpoint increase luminance from 128 to 255 (100%) = white. A DMX value of 64 allows you to view the image at a minimum luminance.

Modifier 2: Scales the x chrominance component. The default DMX value of 128 (50%) = no adjustment. Values below the midpoint scale the x chrominance component down as you approach 0 = minimum. Values above the midpoint up to a maximum. at a value of 255 (100%)

Modifier 3: Scales the y chrominance component. The default DMX value of 128 (50%) = no adjustment. Values below the midpoint scale the y chrominance component down as you approach 0 = minimum. Values above the midpoint scale the y chrominance component up to a maximum at a value of 255 (100%).

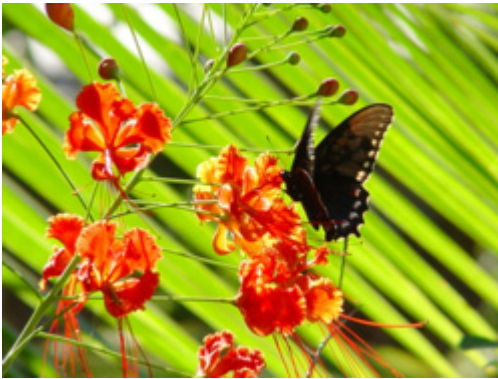

Original Content

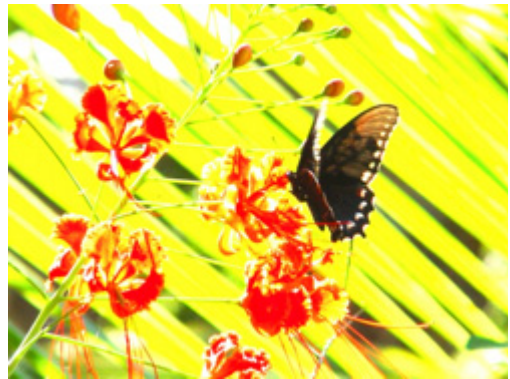

Modifier 1 parameter DMX = 250

Modifier 2 parameter DMX = 128

Modifier 3 parameter DMX = 128

Geometric Effect Options

Cartoon Edge

Object Effect Global Effect

Effect Mode parameter DMX value = 38

Outlines the edges of image components to create a rendered effect.

Modifier 1: Adjusts Color reduction from 0= no adjustment to 255 (100%) = maximum.

Modifier 2: Adjusts contrast enhancement from 0= no adjustment to 255 (100%) = maximum.

Modifier 3: Adjusts ion sensitivity from 0= no adjustment to 255 (100%) = maximum adjustment.



Original Content



Modifier 1 parameter DMX value = 255

Modifier 2 parameter DMX value = 82

Modifier 2 parameter DMX value = 115

Chroma Shift

Object Effect Global Effect

Effect Mode parameter DMX value = 60

This effect shifts the red, blue, and green component colors in an image. You can offset color components vertically and or horizontally.

Modifier 1: The default DMX value of 128 (50%) = no adjustment. Values below the midpoint shift the color components right to a maximum at a value of 0. Values above the midpoint shift the color components left to a maximum at a value of 255 (100%).

Modifier 2: The default DMX value of 128 (50%) = no adjustment. Values below the midpoint shift the color components down to a maximum at a value of 0. Values above the midpoint shift the color components up to a maximum at a value of 255 (100%).

Modifier 3: Not Used

NOTE: *This effect is also available as a Visual Mode adjusted with 2 Modifier parameters, (see Chroma Shift on page 83).*



Original Content



Modifier 1 parameter DMX value = 105
Modifier 2 parameter DMX value = 148
Modifier 2 parameter DMX value = 0

Collage Generator

Object Effect Global Effect

Collage Generator effects let you use multiple DL.3 or DL.2 units to create virtually seamless panoramic media projections with DMX control. You can display either stock (automated collage) or custom content (segmented collage) and effects are available for full 360° projection. For more information about this global effect, see *Chapter 12: Global Functions: Collage Generator™ Effect* on page 131.

Modifier 1: Selects which type of Collage array to use from DMX Values 1-63. A DMX value of 0 = No Collage. DMX Values of 64-255 are reserved and default to No Collage.

Modifier 2: Selects which portion of the grid a particular DL.3 or DL.2 fixture will display. DMX values 0-63 step through grid pattern selected by the Modifier 1 parameter. DMX values 64-255 default to the upper left corner of the grid.

Modifier 3: Adjusts edge blending between the selected portion of the image being projected by the fixture and adjacent portions being projected by other fixtures.

	Automated Collage Generator Options		Segmented Collage Generator Options	
	Flat Collage	360° Wrap	Flat Collage	360° Wrap
Global Effect DMX Value	134			
	141	145	146	147
	150	151	152	153

Collage Generator

Effect Mode parameter DMX value = 134

The standard **Collage Generator** was the original automated collage effect and should only be used with legacy shows.

Enhanced Collage Generator

Effect Mode parameter DMX value = 141

This automated collage effect improves the image resolution over the initial Collage Generator.

Collage Gen 3

Effect Mode parameter DMX value = 150

Collage Gen 3 effect has the image resolution of the **Enhanced Collage Generator** effect and further expands and improves the edge blending control.

Collage Generator Wrap

Effect Mode parameter DMX value = 145

The **Collage Generator Wrap** automated effect adds right and left edge blending to create 360° panoramas.

Collage Gen 3 Wrap

Effect Mode parameter value = 151

This effect expands and enhances edge blending controls of effect 145.

Segmented Collage Generator

Effect Mode parameter DMX value = 146

The **Segmented Collage Generator** effect accepts user defined portion of content for each cell in the grid.

Segmented Collage Gen 3

Effect Mode parameter DMX value = 152

The **Segmented Collage Gen 3** effect accepts user defined portion of content for each cell in the grid with expanded and improved edge blending control to effect 146.

Segmented Collage Generator Wrap

Effect Mode parameter DMX value = 147

The **Segmented Collage Wrap** effect adds right and left edge blending to the user defined cell content to create 360° panoramas.

Segmented Collage Gen 3 Wrap

Effect Mode parameter DMX value = 153

The **Segmented Collage Gen 3 Wrap** effect adds right and left edge blending to the user defined cell content to create 360° panoramas with expanded and improved edge blending control over effect 147.

Curved Surface Support

Object Effect Global Effect

Effect Mode parameter DMX value = 135-149

Curved Surface Support corrects for shape distortions that occur when you project onto surfaces that aren't flat. This Global effect facilitates projecting onto convex or concave cylinders, angular screens, spheres, and disk shaped surfaces.

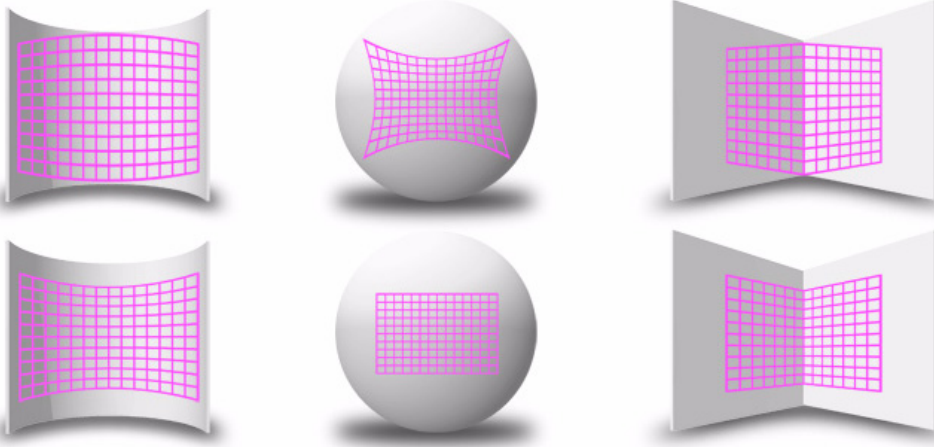

You can apply this correction to any media server output including multi-fixture image panoramas created with the Collage Generator Effect, (see *Global Functions: Collage Generator™ Effect* on page 131).

Use these adjustments in conjunction with Keystone parameters and Ratio parameters to refine the output shape on any of these surfaces.

Effect Mode DMX Value	Surface
135	Curved Vertical Convex Cylinder (opening toward projector)
136	Curved Vertical Concave Cylinder (opening away from projector)
137	Vertical Inside Corner (opening toward projector)
138	Vertical Outside Corner (opening away from projector)
139	Sphere
140	Convex Disk (opening away from projector)
148	Curved Horizontal Convex Cylinder (opening toward projector)
149	Curved Horizontal Concave Cylinder (opening away from projector)

After you have selected the surface, the Modifier parameters operate as described below:

TIP: *Modifier channels for Effect Mode 1 are labeled as CMY in the Wholehog system so you can also make use of the color picker, HSI, and other Wholehog functions. Use the CMY parameter controls to adjust the three Effect Mode 1 Modifier parameters for both the Global and Graphic fixture types. The default for Effect Mode 1 is set to CMY1 as well. Modifier channels for Effect Modes 2 and 3 are labeled Mod 1, Mod 2, and Mod 3.*

Modifier 1: Modifier 1 lets you adjust the amount of correction vertically. A value of 0 = no adjustment. The correction increases as you increase value to maximum at 255 (100%).

Modifier 2: In situations where you are projecting from any angle other than perpendicular to the surface, you can use the Modifier 2 to adjust the vertical center of the image. A DMX value of 128 (50%) = no adjustment. Adjusting toward 0 moves the vertical center down to the bottom of the image. Values above the midrange move the vertical center up to the top of the image at a DMX value of 255 (100%).

Modifier 3: You can use the Modifier 3 parameter to adjust the image's horizontal center when you're projecting onto a sphere, an inside or an outside corner. A DMX value of 128 (50%) = no adjustment. Adjusting toward 0 moves the horizontal center toward the left edge of the image. Values above the midrange move the horizontal center right toward the edge of the image at a DMX value of 255 (100%).

NOTE: *Modifier 3 is not used when projecting onto an inside or outside cylinder*

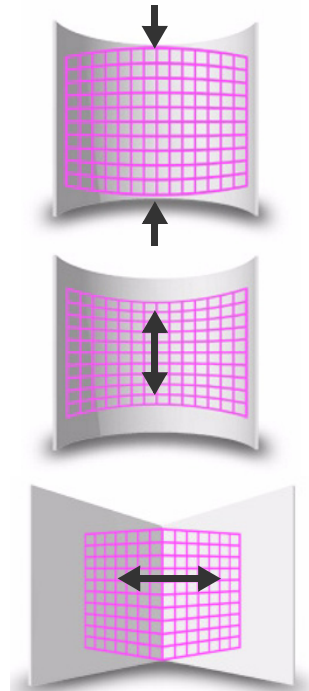

Digital MSpeed

Object Effect Global Effect

Effect Mode parameter DMX value = 103

In an effort to smooth DMX data for rotation, scaling and position values at the Graphic Object level, historically a crossfading algorithm has been applied to these values. Digital MSpeed allows you to set a crossfade speed to these values to achieve smoother fading. The following rules apply to implementing the Digital MSpeed effect:

- This effect can be applied at the Global level or the Graphic Object level but can only be applied once at any given level. That is to say, if applied twice at the global level, only the first (lowest numbered)
- When Digital MSpeed is applied at the global level, the mspeed values are applied to all the Graphic Objects.
- Digital MSpeed applied at the Graphic Object level takes precedence over digital mspeed applied at the Global level. This means you can apply a global value to all the Graphic Objects, and then override that value by assigning a different set of values on a particular Graphic Object.
- Crossfades under digital mspeed control are linear across the fade time. All ramp, snap combinations are set in the control system.

Modifier 1 : applies MSpeed to rotation values. When DMX = 0, no MSpeed is applied, and traditional crossfading can be used. Crossfade times increase from 0 = slowest to 255 = fastest.

Modifier 2 : applies MSpeed to scaling values. When DMX = 0, no MSpeed is applied, and traditional crossfading can be used. Crossfade times increase from 0 = slowest to 255 = fastest.

Modifier 3 : applies MSpeed to position values. When DMX = 0, no MSpeed is applied, and traditional crossfading can be used. Crossfade times increase from 0 = slowest to 255 = fastest.

Downward Vertical Streaks

Object Effect Global Effect

Effect Mode parameter DMX value = 80

This effect lets you convert a portion of the image into vertical streaks. You can also rotate the angle of the streak and fade from the original image to the image with the streak effect applied.

Modifier 1: At a DMX value of 0, there is no effect. Increasing the DMX value sets the length of the streak portion of the image from the bottom up to 255 (100%) = the full image converted to streaks.

Modifier 2: The default DMX value of 128 (50%) = no adjustment. Values below the midpoint move the edge of the streaked portion of the image clockwise as you approach 0 = 90°. Values above the midpoint move the edge of the streaked portion of the image counterclockwise as you approach 90° at a value of 255 (100%).

Modifier 3: When Modifier 1 has a DMX value > 0, Modifier 3 lets you fade from 0 = the original image to 255 (100%) = the converted image.



Original content



Modifier 1 parameter DMX value = 170
Modifier 2 parameter DMX value = 158
Modifier 3 parameter DMX value = 255

Drop Shadow

Object Effect Global Effect

Effect Mode parameter DMX value = 58

This effect creates a black plane behind the selected media file texture on a flat rectangular object. You can bring the plane from behind positioning it to form a drop shadow. You won't see the shadow until you select a Modifier 1 or 2 DMX value above or below 128 (50%).

Modifier 1: The default DMX value of 128 (50%) = no adjustment. Values below the midpoint move the "shadow" right as you approach 0 = maximum horizontal shadow width. Values above the midpoint move the "shadow" left to a maximum horizontal shadow width at a value of 255 (100%)

Modifier 2: The default DMX value of 128 (50%) = no adjustment. Values below the midpoint move the "shadow" down as you approach 0 = maximum vertical shadow width. Values above the midpoint move the "shadow" up to a maximum vertical shadow width at a value of 255 (100%)

Modifier 3: Adjusts the shadow's opacity from 0 = full opacity to 255 (100%) = maximum transparency.

Tip: To ensure that the shadow remains black and is unaffected by other graphic effects, apply it as the last effect selected for an image.

NOTE: *This effect is also available as a Visual Mode adjusted with 2 Modifier parameters, (see Drop Shadow on page 84).*



Original Content



Modifier 1 parameter DMX value= 0
Modifier 2 parameter DMX value=255
Modifier 3 parameter DMX value=0

Faux LED

Object Effect Global Effect

Effect Mode parameter DMX value = 55

This effect divides the image into a grid of circles that mimic an LED wall. The color of the center pixel in each cell defines the solid color for that circle. You can control “LED” size, background and color peaking.

Modifier 1: Controls the “LED” size. The default DMX value of 0 displays a 100 x 100 grid of “LEDs”. Increasing the DMX value decreases the grid divisions to a minimum of 10 x 10 at a value of 255 (100%).

NOTE: *A small number of larger “LEDs” will also result in reduced color variation.*

This effect is also available as a Visual Mode adjusted with 2 Modifier parameters, (see Faux LED on page 86).

Modifier 2: Adjusts the grid spacing and color around each “LED”. A DMX value of 0 = the minimum black line between cells. The spacing increases to a maximum at a DMX value of 127 (49%). At a value of 128 (50%), the space between cells reverts to the minimum spacing and turns white. Increasing the value further increases the white spacing to a maximum at a DMX value of 255 (100%).

Modifier 3: Adjusts the color peaking to simulate lighting at the “LED” center. A DMX value of 0 = no adjustment and flat color across the cell. As you increase the DMX value, the peaking increases to a maximum at 255 (100%).



Original Content

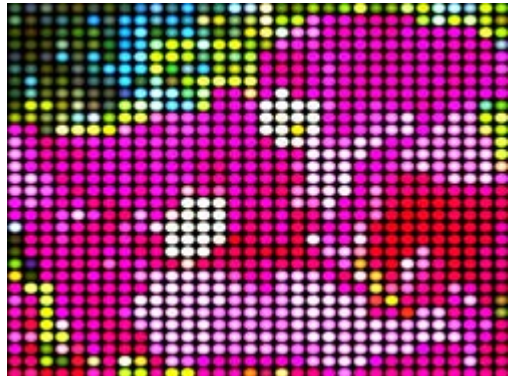

Modifier 1 parameter DMX = 202

Modifier 2 parameter DMX = 16

Modifier 3 parameter DMX = 167

Faux Tile

Object Effect Global Effect

Effect Mode parameter DMX value = 56

This effect divides the image into a grid of tiles with simulated lighting at the edges. The color of the center pixel in each cell defines the solid color for that tile. You can control the number and spacing of tile, choose between a black and white grid and adjust color peaking.

Modifier 1: Controls the tile size. The default DMX value of 0 displays a 100 x 100 grid of tiles. Increasing the DMX value decreases the grid divisions to a minimum of 10 x 10 at a value of 255 (100%).

NOTE: *A small number of larger “tiles” will also result in reduced color variation.*

This effect is also available as a Visual Mode adjusted with 2 Modifier parameters, (see Faux Tile on page 87).

Modifier 2: Adjusts the grid spacing and color around each tile. A DMX value of 0 = the minimum black line between tiles. The spacing increases to a maximum at a DMX value of 127 (49%). At a value of 128 (50%), the space between tiles reverts to the minimum spacing and turns white. Increasing the value further increases the white spacing to a maximum at a DMX value of 255 (100%).

Modifier 3: Adjusts the color peaking to simulate lighting at the tile edges. A DMX value of 0 = no adjustment and flat color across the tile. As you increase the DMX value, the peaking increases to a maximum at 255 (100%).

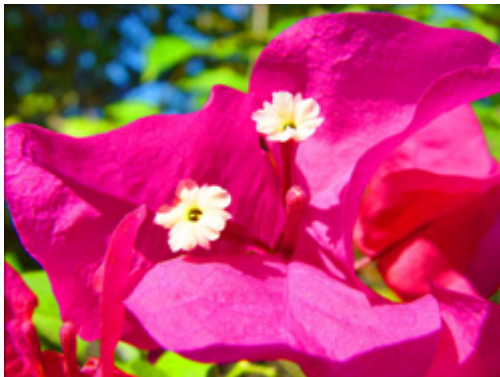

Original Content

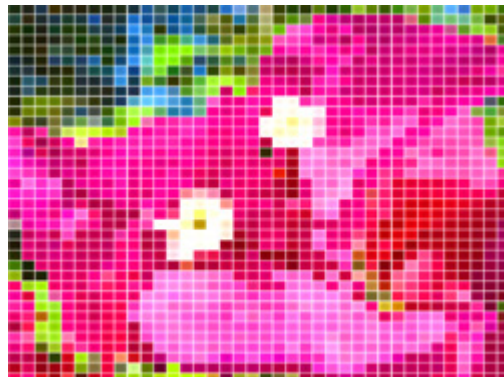

Modifier 1 parameter DMX = 188

Modifier 2 parameter DMX = 139

Modifier 3 parameter DMX = 255

Film Burn/Unburn

Object Effect Global Effect

Effect Mode parameter DMX value = 93

This effect creates multiple burn patterns over the image.

Modifier 1: Adjust the burn-through rate. A DMX value of 65 begins creating a burn pattern with flames from 64 = slowest to 127 = fastest rate. Values below 65 “unburn the pattern from 63 = slowest to 0 = fastest unburn. Values in the upper half of the range create the burn pattern without flames from 192 = slowest to 255 = fastest burn rate. A value of 191 “unburns” the patterns from 191 = slowest to 128 = fastest “unburn” without flames.

Modifier 2: Adjusts the amount of film blackening around the burn areas from 0 = the smallest amount of blackening to 255 (100%) = the largest blackened area.

Modifier 3: Each DMX value selects one of 255 burn patterns.

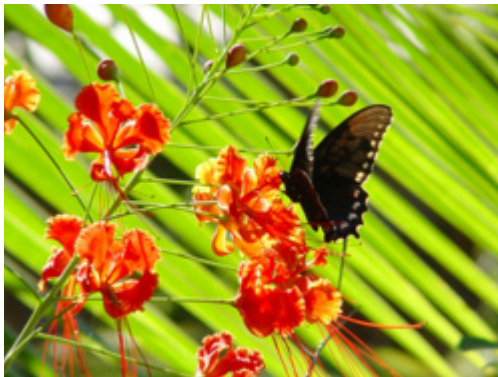

Original Content



Modifier 1 parameter DMX = 152

Modifier 2 parameter DMX = 234

Modifier 3 parameter DMX = 211

Film Noise

Object Effect Global Effect

Effect Mode parameter DMX value = 94

This effect creates the effect of scratches on film. You can adjust the amount of “noise” as well as the tint and “jitter” to give the image an aged film effect.

Modifier 1: Adjusts the noise rate. A DMX value of 128 (50%) pauses the noise. Values below the midpoint adjust the rate from 0 = fastest to 127 = slowest. Values above the midpoint adjust the rate from 129 = slowest to 255 (100%) = fastest.

Modifier 2: Shifts the color to a sepia tint, 128 = no adjustment, 0 to 127 = full sepia. Values above the midpoint of the range repeat the push to sepia with jitter added from 129 (51%) = full color and no jitter to 255 (100%) = full sepia and maximum jitter.

Modifier 3: Reduces the noise level from 0 = maximum noise to 255 (100%) = no noise.

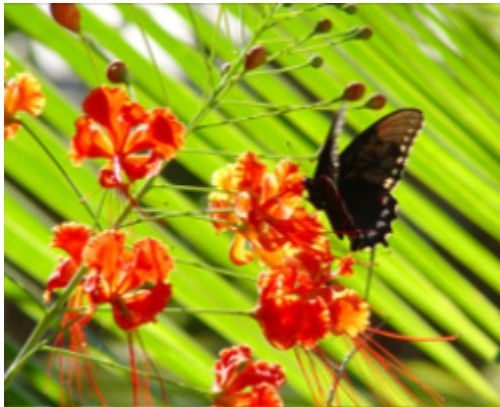

Original Content

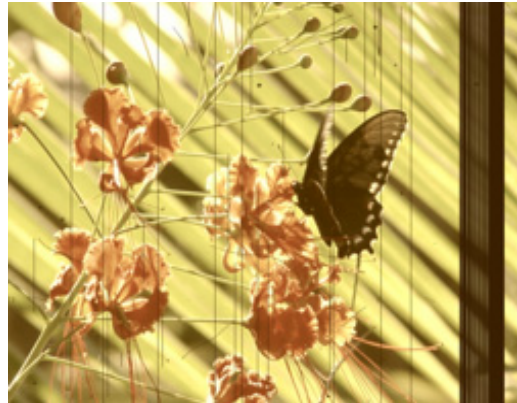

Modifier 1 parameter DMX = 157

Modifier 2 parameter DMX = 94

Modifier 3 parameter DMX = 26

Film Roll

Object Effect Global Effect

Effect Mode parameter DMX value = 53

This effect scrolls the media file texture horizontally or vertically independent from the 3-D object it overlays, and allows you to control the scrolling speed and image scaling.

Modifier 1: The default DMX value of 128 (50%) = no adjustment. Values below the midpoint scroll left, increasing in speed as you approach 0. Values above the midpoint scroll right, increasing in speed to 255 (100%).

Modifier 2: The default DMX value of 128 (50%) = no adjustment. Values below the midpoint scroll down, increasing in speed as you approach 0. Values above the midpoint scroll up, increasing in speed to 255 (100%).

Modifier 3: Scales the image from 0 = no adjustment to maximum tiling at 255.

NOTE: *This effect is also available as a Visual Mode adjusted with 2 Modifier parameters, (see Film Roll on page 88).*

Flip

Object Effect Global Effect

Effect Mode parameter DMX value = 83

This effect scrolls the media file texture horizontally or vertically independent from the 3-D object it overlays, and allows you to control the scrolling speed and image scaling.

Modifier 1: DMX values from 0-127 have no effect. DMX values of 128 (50%) to = 255 (100%) flips the image horizontally.

Modifier 2: DMX values from 0-127 have no effect. DMX values of 128 (50%) to = 255 (100%) flips the image vertically.

Modifier 3: Not used



Original content



Modifier 1 parameter DMX = 128
Modifier 2 parameter DMX = 0



Modifier 1 parameter DMX = 128
Modifier 2 parameter DMX = 128

Edge Frame Profiles

Object Effect Global Effect

Effect Mode parameter DMX value = 133

This effect contains three modes that modify the **Global Image Edge Fade** parameters to frame the global composite image. Modifier 2 and Modifier 3 adjustments vary depending which of the framing modes is selected with Modifier 1.

NOTE: *If the Global Image Edge Fade DMX values are set to Zero, the Framing output will be unseen in modes 0 and 1.*

The images below show examples of the first two framing modes. In the image on the left Modifier 1 selects the internal profile framing option, with Modifier 2 selecting the frame pattern.

In the example on the right, Modifier 1 selects the Graphic Object texture framing option, with Modifier 2 selecting the frame pattern. A Modifier 3 DMX value = 10 designates the Frame texture as Graphic Object 2's media file content minus any applied effects.

NOTE: *Global Image Edge Fade DMX values = 100.*



Effect Mode parameter = 133
Modifier 1 parameter DMX = 0
Modifier 2 parameter DMX = 15
Modifier 3 Not Used

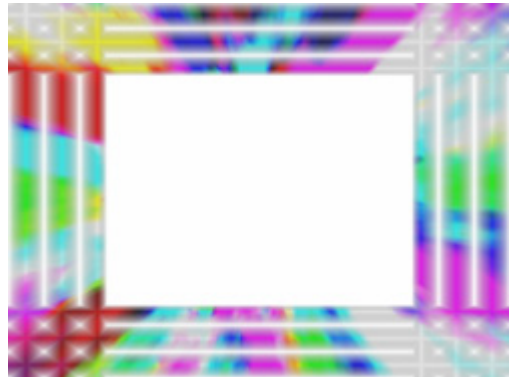

Effect Mode parameter = 133
Modifier 1 parameter DMX = 1
Modifier 2 parameter DMX = 251
Modifier 3 parameter DMX = 10

Framing Shutter Emulation

When Modifier 1 is set to a DMX value = 2, Modifier parameters 2 and 3 are not used. Instead, the four **Global Image Edge Fade** parameters control image to emulate framing shutters. In the example to the right, each **Image Edge Fade** parameter has been set to a DMX value = 100.

NOTE: *This technique is useful when you are running Version 1 Protocol. Version 2 Protocol provides a much better solution for this situation with eight Framing Shutter channels.*



Modifier 1: This parameter allows you to select from three framing modes.

DMX Value	Action
0	Frames the image using an Internal Frame profile to control the Global Fade Edge parameter appearance.
1	Frames the image using an Internal Frame profile to control the Global Fade Edge parameter appearance. Rendered Graphic Object content is selected at Frame texture using Modifier 3 parameter
2	Image clipping changing operation of the Global Image Edge Fade parameters to Emulate Framing Shutters

Modifier 2: When the Modifier 1 DMX value = 0 or 1, this channel selects from profiles that vary in gradient density or pattern. When Modifier 1 DMX value = 2, this Modifier is not used.

Modifier 3: When Modifier 1 DMX Value = 1, this parameter determines how to use the rendered Graphic Object content as a texture for the frame. When Modifier 1 DMX value = 2, this Modifier is not used.

Modifier 1 DMX Value	Modifier 3	
	DMX value	Action
0	NA	Not Used
1	0	Graphic Object 1 texture without applied Effects
	1	Graphic Object 1 texture including its first applied Effect
	2	Graphic Object 1 texture including its first two applied Effects
	3	Graphic Object 1 texture including its first three applied Effects
	10	Graphic Object 2 texture without applied Effects
	11	Graphic Object 2 texture including its first applied Effect
	12	Graphic Object 2 texture including its first two applied Effects
	13	Graphic Object 2 texture including its first three applied Effects
	20	Graphic Object 3 texture without applied Effects
	21	Graphic Object 3 texture including its first applied Effect
	22	Graphic Object 3 texture including its first two applied Effects
23	Graphic Object 3 texture including its first three applied Effects	
2	NA	Not Used

Fuzzifier

Object Effect Global Effect

Effect Mode parameter DMX value = 57

This effect offsets multiple images of the media file texture to blur the image, and lets you to control image scaling at the same time.

Modifier 1: The default DMX value of 0 = no adjustment. Increasing DMX values blur the image horizontally to a maximum at a DMX value of 255 (100%).

Modifier 2: The default DMX value of 0 = no adjustment. Increasing DMX values blur the image vertically to a maximum at a DMX value of 255 (100%).

Modifier 3: Adjusts the decay level of the blurred edge from 0 = no adjustment to maximum full decay at 255.



Original Content



Modifier 1 parameter DMX =255 (100%)

Modifier 2 parameter DMX =255 (100%)

Modifier 3 parameter DMX = 0

NOTE: *This effect is also available as a Visual Mode adjusted with 2 Modifier parameters, (see Fuzzifier on page 90).*

Gaussian Blur

Object Effect Global Effect

Effect Mode parameter DMX value = 81

More precise than Fuzzifier effect, this effect creates a true blur effect utilizing a gaussian curve.

Modifiers 1 and **Modifier 2** combine to create the effect. When Modifiers 1 and 2 both have a value >0, there is no Blur. Increasing Modifier 1 and Modifier 2 values increases the sample distance and number of filter passes.

Modifier 3: Applies a range of curve shapes from a DMX value = 0 through 255 (100%).



Original Content



Modifier 1 parameter DMX = 128,
Modifier 2 parameter DMX = 128
Modifier 3 parameter DMX = 128



Modifier 1 parameter DMX = 255,
Modifier 2 parameter DMX = 255
Modifier 3 parameter DMX = 255

Gaussian Halo

Object Effect Global Effect

Effect Mode parameter DMX value = 99

This effect blurs the content from around a circular area in the center of the image toward the edges.

NOTE: *Adjusting Mod 3, then Mod 1 and finally Mod 2 will give the best results with the least CPU demand.*

Modifier 1 : Increases the sample distance to determine the “smoothness” of the blurring from 0 = minimum to 255 (100%) = maximum.

Modifier 2 : Increases the number of filter passes from 0 = one pass to 255 (100%) = a maximum of sixteen filter passes

Modifier 3: Applies a range of curve shapes from 0 = no adjustment to 255 (100%) = maximum adjustment.

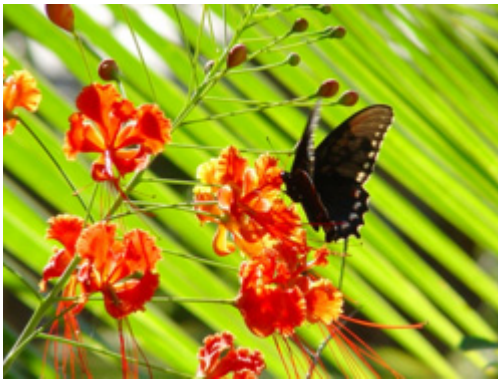

Original Content

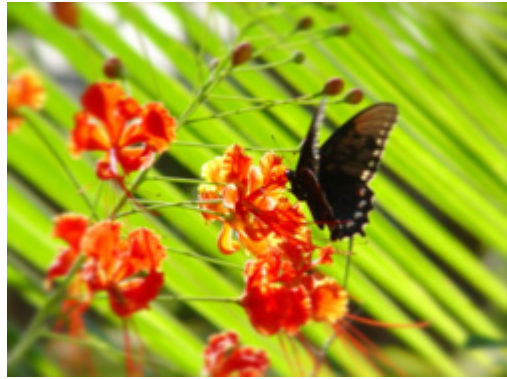

Modifier 1 parameter DMX = 193,
Modifier 2 parameter DMX = 255
Modifier 3 parameter DMX = 255

Horizontal Mirror

Object Effect Global Effect

Effect Mode parameter DMX value = 40

This effect duplicates the image vertically and mirrors the image alongside its original.

Modifier 1: The default DMX value of 128 (50%) sets the center point of the edge where the duplicate images meet at the center of the screen. Values below the midpoint move the center point toward the left as you approach 0. Values above the midpoint move the center point toward the right as you approach 255 (100%).

Modifier 2: Not Used

Modifier 3: Not Used



Original Content



Effect Mode parameter DMX = 40
Modifier 1 parameter DMX = 0



Effect Mode parameter DMX = 40
Modifier 1 parameter DMX = 134

Image Scale and Rotate

Object Effect Global Effect

Effect Mode parameter DMX value = 52

This effect lets you scale and rotate the media file texture applied to a 3-D object's surface independent of Graphic Object rotation you set with the Rotation parameters (see *Rotating a 3-D Object* on page 67). This allows scaling and rotating outside the bounds of the 3D object.

Modifier 1: Scales the texture. The default DMX value of 0 = no adjustment. As you increase the DMX value to 255 (100%), the single image to scales to an increasing number of multiple images similar to tiling.

Modifier 2: Sets the texture rotation angle. A DMX value of 128 (50%) = no adjustment. Values above the midpoint rotate clockwise 255 (100%) = maximum rotation. Values below the midpoint rotate counterclockwise to 0=maximum rotation.

Modifier 3: Sets the rotation speed from a DMX value of 0 = static to 255 (100%) = maximum.



Original Content

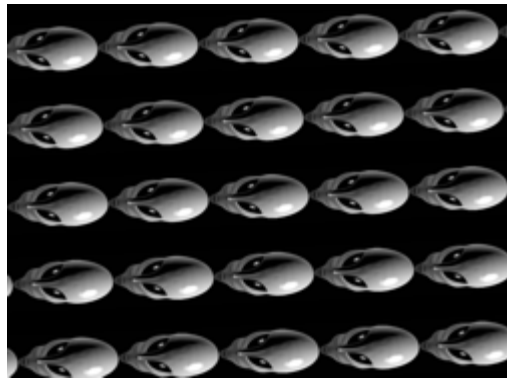

Modifier 1 parameter DMX = 255

Modifier 2 parameter DMX = 0

Modifier 3 parameter DMX = 0



Modifier 1 parameter DMX = 255,

Modifier 2 parameter DMX = 81

Modifier 3 parameter DMX = 128

Lens Grid

Object Effect Global Effect

Effect Mode parameter DMX value = 91

This effect lets you view the image through a grid of virtual convex lenses. You can adjust the number, magnification and edge shading of the lenses over the image.

Modifier 1: Controls the horizontal position of the lens' centerpoint from 0 = left edge to 255 (100%) = right edge of output.

Modifier 2: Controls the edge shading.

Modifier 3: Controls the number of the lens from DMX values of 0 = many to 255 (100%) = single lens.

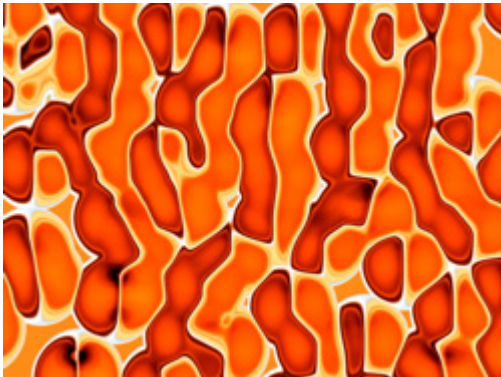

Original Content

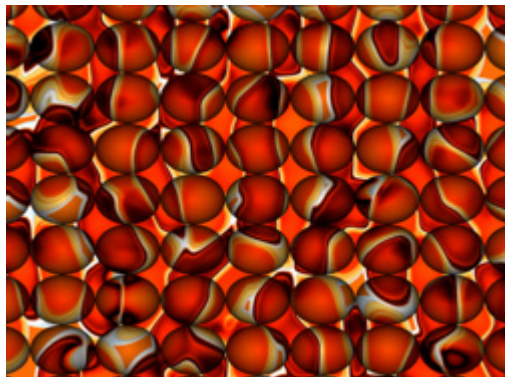

Modifier 1 parameter DMX = 12
Modifier 2 parameter DMX = 112
Modifier 3 parameter DMX = 33

Magnifying Lens

Object Effect Global Effect

Effect Mode parameter DMX value = 36

This effect applies spherical overlay that magnifies a portion of the texture to create a virtual convex lens effect over a portion of the image. You can adjust the size of the lens and *move* it over different areas of the image.

Modifier 1: Controls the horizontal position of the lens' centerpoint from 0 = left edge to 255 (100%) = right edge of output.

Modifier 2: Controls the vertical position of the lens' centerpoint from 0 = top edge to 255 (100%) = bottom edge of output.

Modifier 3: Controls the size of the lens from 0 = smallest to 255 (100%) = largest.



Original Content



Modifier 1 parameter DMX = 107

Modifier 2 parameter DMX = 143

Modifier 3 parameter DMX = 61

Magnifying Lens 2

Object Effect Global Effect

Effect Mode parameter DMX value = 37

This effect applies spherical overlay that magnifies a portion of the texture to create a doubled virtual convex lens over a portion of the image. You can adjust the size of the lens and *move* it over different areas of the image.

Modifier 1: Controls the horizontal position of the lens' centerpoint from 0=left edge to 255 (100%) = right edge of output.

Modifier 2: Controls the vertical position of the lens' centerpoint from 0=top edge to 255 (100%) = bottom edge of output.

Modifier 3: Controls the size of the lens from 0=smallest to 255 (100%) = largest.

Tip: Zooming in with this lens effect creates an additional effect.



Original Content



Modifier 1 parameter DMX = 107

Modifier 2 parameter DMX = 143

Modifier 3 parameter DMX = 61

Mattes

Object Effect Global Effect

Effect Mode parameter DMX value = 144

The Global Effect lets you select from a variety of provided patterns to superimpose over the composite image. Modifier parameters select the pattern and effects for a matte.

The images below show two examples of the Mattes effect. In the image on the left, the Modifier 2 value selected the matte pattern. Modifier 1 sets black as transparent. The Modifier 3 value corresponds with a lookup to an internal gradient map to determine the matte color.

In the example on the right, the same Matte is selected by Modifier 2. This time the Modifier 1 value selects white as transparent and uses a graphic object as a texture. A Modifier 3 DMX value of 0 designates the Matte texture as Graphic Object 1's media file content minus any applied effects.

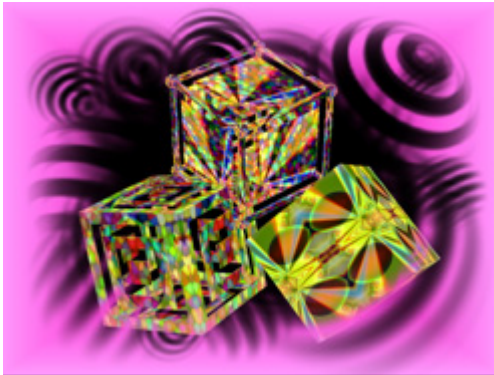

Modifier parameter 1 DMX = 11
Modifier parameter 2 DMX = 13
Modifier parameter 3 DMX = 203

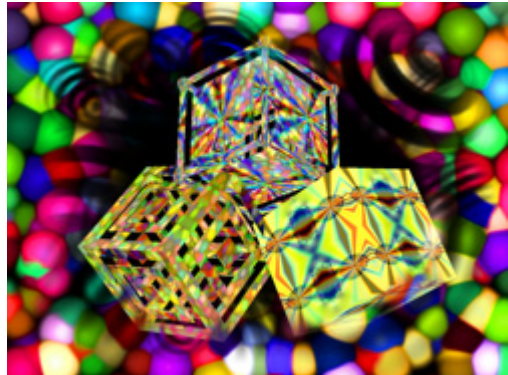

Modifier parameter 1 DMX = 5
Modifier parameter 2 DMX = 13
Modifier parameter 3 DMX = 0

Modifier 1: This parameter determines transparency and color effects for the selected matte:

DMX value	Modifier 1 Action
0	Black transparent, use matte color
1	Black transparent, inverting matte color
2	White transparent, use matte color
3	White transparent, then invert matte color
4	Black transparent using a Graphic Object media file content as the matte texture
5	White transparent using a Graphic Object media file content as the matte texture
6	Black transparent with grayscale used as alpha
7	White transparent with grayscale used as alpha
8	Black transparent with grayscale not used as alpha
9	White transparent with grayscale not used as alpha
10	Black transparent, with matte color controlled by Modifier 3 as lookup in internal color gradient map
11	Black transparent, with matte color controlled by Modifier 3 as lookup in internal color gradient map and inverted

Modifier 2: The first 20 DMX values are assigned to the following Matte pattern options:

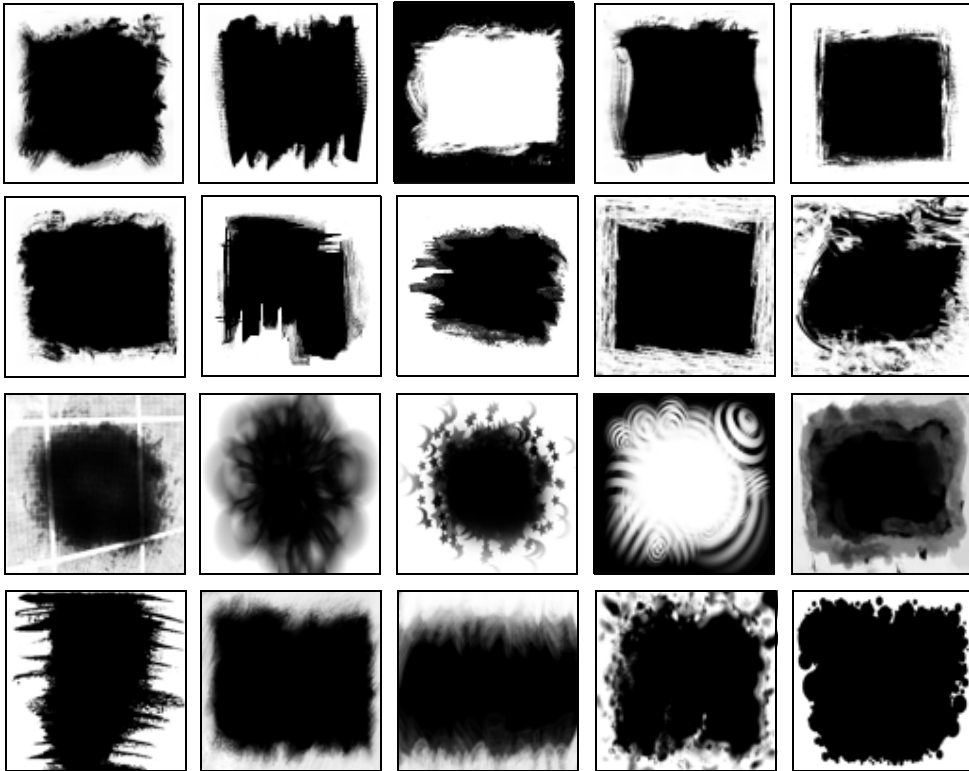

Modifier 3: This parameter determines the texture for the Matte mode selected with the Modifier 1 parameter.

Modifier 1 DMX Value	Modifier 3	
	DMX value	Action
0 - 3	NA	Not Used
4 - 9	0	Graphic Object 1 texture without applied Effects
	1	Graphic Object 1 texture including its first applied Effect
	2	Graphic Object 1 texture including its first two applied Effects
	3	Graphic Object 1 texture including its first three applied Effects
	10	Graphic Object 2 texture without applied Effects
	11	Graphic Object 2 texture including its first applied Effect
	12	Graphic Object 2 texture including its first two applied Effects
	13	Graphic Object 2 texture including its first three applied Effects
	20	Graphic Object 3 texture without applied Effects
	21	Graphic Object 3 texture including its first applied Effect
10 - 11	22	Graphic Object 3 texture including its first two applied Effects
	23	Graphic Object 3 texture including its first three applied Effects
	0-255	Color selected as a look up value from an internal gradient.

Pan and Scan

Object Effect Global Effect

Effect Mode parameter DMX value = 255

This effect Zooms into a still image and then, by changing position, you can pan across the image horizontally and vertically. It only functions on image sizes greater than 1024 x 1024 in at least one direction.

Modifier 1: Adjusts the horizontal pan position from 0=left edge to 255 (100%) = right edge of the image. The default DMX value of 128 (50%) = no adjustment.

Modifier 2: Adjusts the vertical pan position from 0 = bottom edge to 255 (100%) = top edge of the image. The default DMX value of 128 (50%) = no adjustment.

Modifier 3: The default DMX value is 0 = no zoom. Increasing the value, increases the zoom into the image to a maximum at a value of 255 (100%). The total Zoom range is proportional to the image size.

Tip: Although you can apply this effect in several different modes (global, graphic and visual), the modifier channel adjustments will only function if there is enough “room” left on the image to move. In most cases the first application of this effect will be the only one to have an effect.

NOTE: *This effect is also available as a Visual Mode adjusted with 2 Modifier parameters, (see Pan and Scan on page 95).*

Particle System

Object Effect Global Effect

Three Particle System effects operate together to create a particle pattern effect. By using all three effects, you can, in effect, apply nine modifier adjustments.

NOTE: *You must use the Particle System 1 effect. Then you can add Particle System 2 and Particle System 3 for additional Modifier support to the initial effect.*

Particle System I

Effect Mode parameter DMX value = 95

This option provides the baseline effect.

Modifier 1: Determines emitter pattern that will shape the particle effect. Multiple emitter patterns are available and more will be added in subsequent releases. All DMX values after the last pattern variation default to the first emitter pattern (Random Within Rectangle).

DMX value	Modifier 1 Action
0	RandomWithinRectangle
1	RandomOnRectangle
2	RandomOnRectangleInward
3	RandomOnRectangleOutward
4	RandomInCircle
5	RandomOnCircleInward,
6	RandomOnCircleOutward,
7	RandomAtTop,
8	RandomAtRight,
9	RandomAtBottom,
10	RandomAtLeft,
11	RandomAtTopAndRight,
12	RandomAtRightAndBottom,
13	RandomAtBottomAndLeft,
14	RandomAtLeftAndTop
15	RandomAtTopRightBottomLeft
16	SequentialTopToBottom

DMX value	Modifier 1 Action
17	SequentialRightToLeft
18	SequentialBottomToTop
19	SequentialLeftToRight
20	SequentialClockwise
21	RandomTopLeftRadial
22	RandomTopRightRadial
23	RandomBottomRightRadial
24	RandomBottomLeftRadial
25	RandomTopLeftRightRadial
26	RandomBottomRightLeftRadial
27	RandomFourCorners
28	RandomStaticInsideRectangle
29	RandomStaticOutsideRectangle
30	RandomStaticOnRectangle
31	RandomStaticInsideCircle
32	RandomStaticOutsideCircle
33	RandomStaticOnCircle

Modifier 2: Adjusts the trailing of each particle as it moves across the image from 0 = smallest trail to 255 (100%) = longest.

Modifier 3: This parameter determines particle acceleration. A DMX value of 128 (50%) is the default. Values on each side of the midpoint increase the particle acceleration from 0 = slowest to 127 (49%) = fastest and from 129 (51%) = slowest to 255 (100%) = fastest.

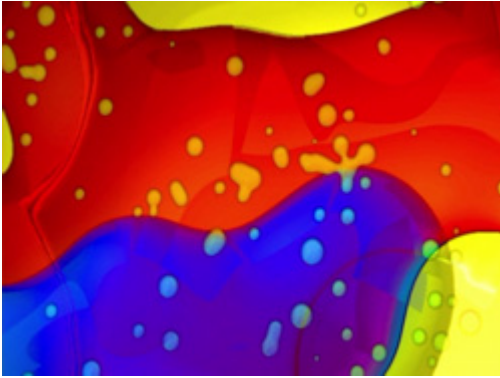

Original Content

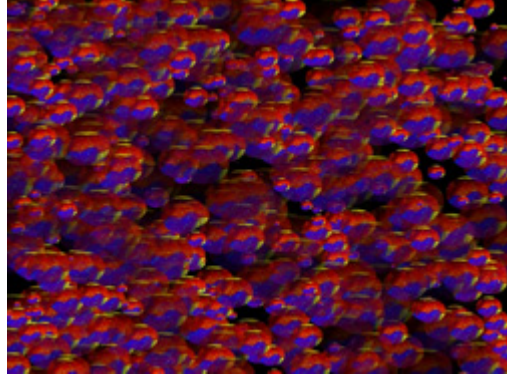

Content with Particle 1 effect applied.
Modifier 1 parameter DMX = 0
Modifier 2 parameter DMX = 0
Modifier 3 parameter DMX = 0

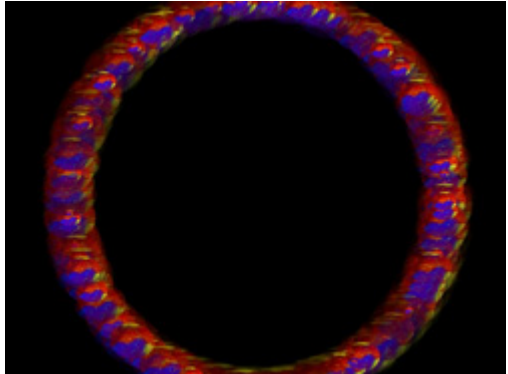

Modifier 1 parameter DMX = 33
Modifier 2 parameter DMX = 0
Modifier 3 parameter DMX = 0

Particle System 2

Effect Mode parameter DMX value = 96

This option can be used to add additional modifier adjustments to the baseline effect you set up in the Particle System 1 effect.

Modifier 1: Determines the number of particles from 0 = smallest number to 255 (100%) = largest number of particles.

Modifier 2: Adjusts particle size from 0 = smallest to 255 (100%) = largest particle size.

TIP: *Reducing the particle size enhances any trailing you set in the Particle System 1 effect.*

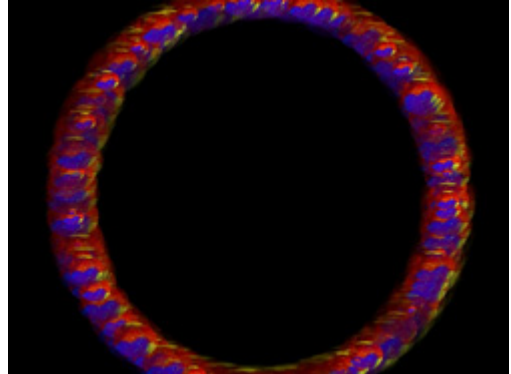

Modifier parameter 1 DMX value = 45

Modifier parameter 2 DMX value = 62

Modifier parameter 3 DMX value = 0

Modifier 3: Adjusts the size of the emitter shape you selected in the Particle System 1 effect by spreading the source area from 0 = the smallest source area to 255 (100%) = the largest.

Particle System 3

Effect Mode parameter DMX value = 97

If you have already selected the Particle System 1 and 2 effects, you can further adjust the effect with this option.

Modifier 1: Sets the Initial Particle Velocity from 0 = slowest to 255 (100%) = fastest.

Modifier 2: Sets the particle rotation. A DMX value of 128 (50%) = no rotation. Values above the midpoint rotate counterclockwise from 129 = slowest to 255 (100%) = fastest. Values below the midpoint rotate clockwise from 0 = fastest to 127 = slowest.

Modifier 3: Sets the particle lifetime from 0 = shortest to 255 (100%) = longest

Picture in Picture

Object Effect Global Effect

Effect Mode parameter DMX value = 35

This effects creates a window in the image containing a scaled down version of the same image and then lets you position it anywhere on the output plane.

Modifier 1: Controls the horizontal position of the subpicture's centerpoint from 0=left edge to 255 (100%) = right edge of output.

Modifier 2: Controls the vertical position of the subpicture's centerpoint from 0=top edge to 255 (100%) = bottom edge of output.

Modifier 3: Controls the size of the picture from 0=smallest to 255 (100%) = largest.



Original Content



Modifier parameter 1 DMX value = 176

Modifier parameter 2 DMX value = 76

Modifier parameter 3 DMX value =133

Prerotation Translation

Object Effect Global Effect

Effect Mode parameter DMX value = 102

Rotation parameters rotate the center of an image around the x, y or z axis. The Prerotation Translation Effect Mode option allows you to position the image in a virtual 3-dimensional space. Then, when the Rotation parameters for the object are applied, the image will orbit around each axis from this new position.

NOTE: *When this option is applied as a Global effect, it will include any prerotation translation selected as an Object effect.*

Modifier 1: Moves the horizontal position of the image centerpoint from 0 = left edge to 255 (100%) = right edge of output.

Modifier 2: Controls the vertical position of the subpicture's centerpoint from 0=top edge to 255 (100%) = bottom edge of output.

Modifier 3: Controls the size of the picture from 0=smallest to 255 (100%) = largest.

Pixelate

Object Effect Global Effect

Effect Mode parameter DMX value = 54

This effects divides the image into rectangles using the center pixel color of each “box” as its color. You can control the number of boxes, and adjust the vertical and horizontal dimensions.

Modifier 1: Controls the number of divisions. Fewer, larger boxes will also result in reduced color variations.

Modifier 2: Reduces the box size horizontally to centerpoint from 0= no reduction to 255 (100%) = full reduction. At that point, the image will then be composed of series of horizontal bands.

Modifier 3: Reduces the box size vertically to centerpoint from 0= no reduction to 255 (100%) = full reduction. At that point, the image becomes a series of vertical bands.

NOTE: *This effect is also available as a Visual Mode adjusted with 2 Modifier parameters, (see Pixelate on page 96).*



Original Content

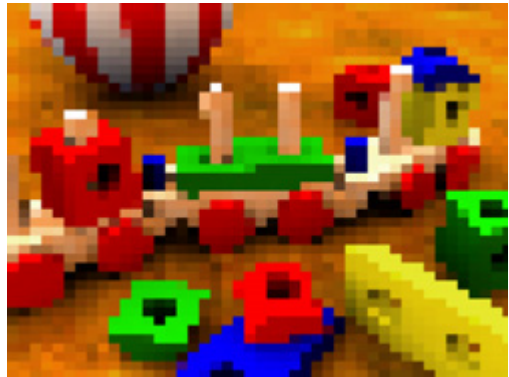

Modifier 1 parameter DMX = 93

Modifier 2 parameter DMX = 7

Modifier 3 parameter DMX = 0

Pixel Twist

Object Effect Global Effect

Effect Mode parameter DMX value = 34

This effect introduces a twisted area to the image and allows to you size it and move it in the image.

Modifier 1: Controls the horizontal position of the twisted area's centerpoint from 0=left edge to 255 (100%) = right edge of output.

Modifier 2: Controls the vertical position of the twisted area's centerpoint from 0=top edge to 255 (100%) = bottom edge of output.

Modifier 3: Controls the direction and amount of twist. At the midpoint of the range, there is no change in the image. The twist area and size moves counterclockwise from 128 (50%) = smallest area to 0 = largest twist area moving counterclockwise. The twist area and size moves clockwise from 128 (50%) = smallest area to 255 (100%)= largest twist area moving clockwise.

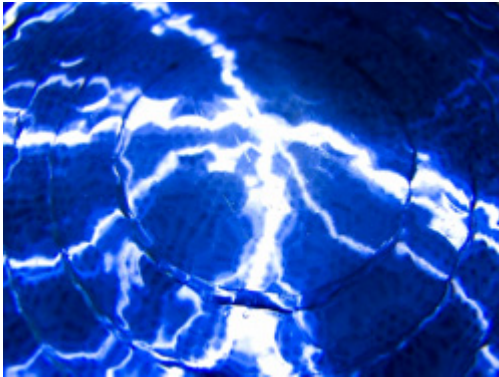

Original Content

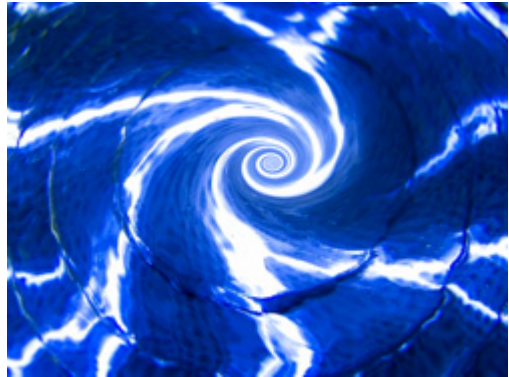

Modifier 1 parameter DMX = 134
Modifier 2 parameter DMX = 106
Modifier 3 parameter DMX = 193

Prism

Effect Mode parameter DMX value = 98

This effect imitates looking at the image through a prism that you define with the Modifier parameters.

Modifier 1: Sets the number of facets. A DMX value of 0 = no facets. The number of facets increase from 10 = three facets to 255 (100%) = maximum 16 facets.

Modifier 2: Sets the refraction index from 0 = minimum to 255 = maximum

Modifier 3: Rotates the prism. The default value is 128 (50%). Values below the midpoint rotate clockwise from 0 = fastest to 127 = slowest rotation. Values above the midpoint rotate counterclockwise from 129 = fastest to 255 = slowest rotation.

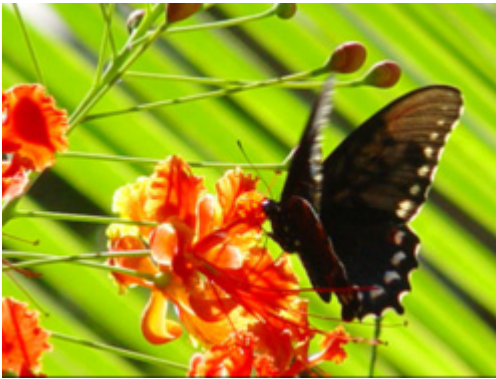

Original Content



Modifier 1 parameter DMX = 255

Modifier 2 parameter DMX = 107

Modifier 3 parameter DMX = 155

Raindrop

Object Effect Global Effect

Effects Mode parameter DMX value = 46

This effect simulates a raindrop distortion on a surface.

Modifier 1: Controls the drop size from 0 = no drop to 255 (100%) = maximum size.

Modifier 2: Sets the random number generator seed number. This lets you create a repeatable random sequence that will synchronize correctly when using the Collage Generator effect, see *page 186*.

Modifier 3: Adjusts the raindrop creation rate from 0 = no adjustment to 255 (100%) = maximum rate.



Original Content



Modifier parameter 1 DMX value = 255

Modifier parameter 2 DMX value = 255

Modifier parameter 3 DMX value = 185

Scene Change

Object Effect Global Effect

Effect Mode parameter DMX value = 100

This effect creates transparency in video content based on the change in pixel color from one frame to the next. Modifiers 1 and 2 use the color difference between the current frame and the previous frame to derive an alpha value for the output frame. Modifier 3 scales the color of the current frame to provide the color of the output frame.

Modifier 1: Scales RGB values of the previous frame; from 0 = maximum to 255 = minimum scaling.

Modifier 2: Derives an alpha value from color difference between current frame and the result of modifier 1. DMX 0 to 127 act to make darker colors transparent, with DMX 0 resulting in maximum transparency. DMX values 128 to 255 act to make bright colors transparent, with DMX 255 = maximum transparency.

Modifier 3: Scales the RGB values of the current frame to provide the output RGB values. DMX 0 provides the brightest output RGB values. DMX 255 = the darkest output RGB values.

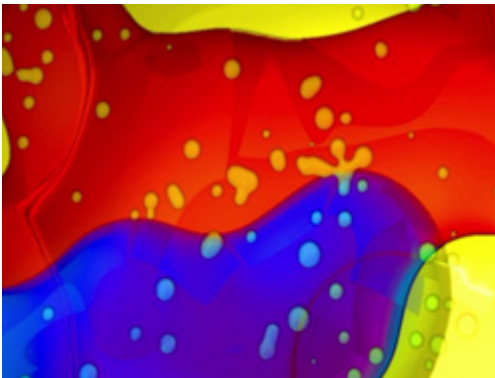

Object 1 Original Content



Object 2 Original Content

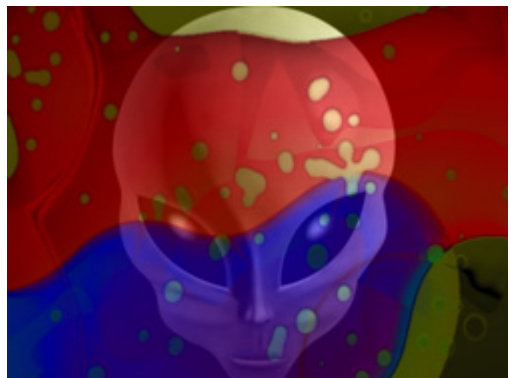

Modifier parameter 1 DMX value = 0

Modifier parameter 2 DMX value = 255

Modifier parameter 3 DMX value = 185

ShakeNBake

Object Effect Global Effect

Effect Mode parameter DMX value = 61

This effect randomly vibrates the image. You can control the horizontal and vertical frequency.

Modifier 1: Adjusts random horizontal “shake” from the shortest refresh rate at a value = 0 to a maximum at a DMX value of 255 (100%).

Modifier 2: Adjusts random vertical “shake” from the shortest refresh rate at a value = 0 to a maximum at a DMX value of 255 (100%).

Modifier 3: Adjusts how much the image is allowed to move from a minimum at a DMX value of 0 to a maximum at a DMX value of 255 (100%).

Tip: To get the maximum effect, set a high value for Modifier 3 and low values for Modifiers 1 and 2.

NOTE: *This effect is also available as a Visual Mode adjusted with 2 Modifier parameters, (see ShakeNBake on page 100).*

Sinewave, Circular

Object Effect Global Effect

Sinewave, Circular ω /X Axis Wobulation

Effect Mode parameter DMX value = 64

Sinewave, Circular ω /Y Axis Wobulation

Effect Mode parameter DMX value = 65

Sinewave, Circular ω /Z Axis Wobulation

Effect Mode parameter DMX value = 66

These effects create a circular sinewave pattern and then vary the boundaries of the underlying object along the designated axis without affecting the media file that is applied as a texture.

Modifier 1: Adjusts the size (amplitude) of the wobble from 0 = no adjustment to 255 (100%) = maximum size.

Modifier 2: Adjusts the rate (frequency) of the wobble from 0 = no adjustment to 255 (100%) = maximum rate.

Modifier 3: Adjusts the offset (phase) of the wobble from 0 = no adjustment to 255 (100%) = maximum offset.

Sinewave, Horizontal

Object Effect Global Effect

Sinewave, Horizontal ω /X Axis Wobulation

Effect Mode parameter DMX value = 67

Sinewave, Horizontal ω /Y Axis Wobulation

Effect Mode parameter DMX value = 68

Sinewave, Horizontal ω /Z axis Wobulation

Effect Mode parameter DMX value = 69

These effects create a horizontal sinewave pattern and then vary the boundaries of the underlying object along the designated axis without affecting the media file that is applied as a texture.

Modifier 1: Adjusts the size (amplitude) of the wobble from 0 = no adjustment to 255 (100%) = maximum size.

Modifier 2: Adjusts the rate (frequency) of the wobble from 0 = no adjustment to 255 (100%) = maximum rate.

Modifier 3: Adjusts the offset (phase) of the wobble from 0 = no adjustment to 255 (100%) = maximum offset.

Sinewave, Vertical

Object Effect Global Effect

Sinewave, Vertical ω /X Axis Wobulation

Effect Mode parameter DMX value = 70

Sinewave, Vertical ω /Y Axis Wobulation

Effect Mode parameter DMX value = 71

Sinewave, Vertical ω /Z Axis Wobulation

Effect Mode parameter DMX value = 72

This effect creates a Vertical sinewave pattern and then varies the boundaries of the underlying object along the X axis without affecting the media file that is applied as a texture.

Modifier 1: Adjusts the size (amplitude) of the wobble from 0 = no adjustment to 255 (100%) = maximum size.

Modifier 2: Adjusts the rate (frequency) of the wobble from 0 = no adjustment to 255 (100%) = maximum rate.

Modifier 3: Adjusts the offset (phase) of the wobble from 0 = no adjustment to 255 (100%) = maximum offset.

Slats

Object Effect Global Effect

Vertical Slats

Effect Mode parameter DMX value = 62

Horizontal Slats

Effect Mode parameter DMX value = 63

These effects render the image in offset slats.

Modifier 1: Adjusts the number of slats from from a DMX value of 0 = no slate to 255 = the maximum number of slats.

Modifier 2: Adjusts the displacement of the slats from a DMX value of 0 = no displacement to 255 = image completely removed from screen.

Modifier 3: When the DMX value for Modifier 1 >0, Modifier 3 fades from the original image to the slatted image. A DMX value of 0 = the original image with no effect applied. Increasing the value fades to the slatted image with 255 = the slatted image at full opacity.



Original Content

Vertical Slat Option



Effect Mode parameter DMX = 62
Modifier 1 parameter DMX = 204
Modifier 2 parameter DMX = 40
Modifier 3 parameter DMX = 255

Horizontal Slat Option



Effect Mode parameter DMX value = 63
Modifier 1 parameter DMX = 204
Modifier 2 parameter DMX = 40
Modifier 3 parameter DMX = 255

Spherical Mapping

Object Effect Global Effect

Spherical Mapping adjusts a rectangular output to project on a portion of a sphere. It is especially useful for projecting a Collage onto a sphere or a portion of a sphere. Spherical mapping utilizes a total of nine Effect Modifier parameters to adjust positioning. In addition to the three modifiers associated with the Global Effect, two Graphics Object Effects provide six additional Modifier parameters. Use these adjustments in conjunction with Keystone parameters and Ratio parameters to refine the output shape on the spherical surface.

For a more information and a detailed setup guide for Spherical Mapping, see *Mapping a Collage to a Spherical Surface* on page 138.

Spherical Mapping, Outside

Effect Mode parameter DMX value = 142

This effect corrects shape distortions and controls blending for Collages projected onto the outside surface of a sphere.

Spherical Mapping, Inside

Effect Mode parameter DMX value = 143

This Global Effect corrects shape distortions and controls blending for Collages projected onto the inside surface of a sphere.

Modifier Parameter Adjustments

When Spherical Mapping is selected, the associated Global Effect Modifier parameters adjust as follows:

Modifier 1: Adjusts the longitude (horizontal) angle. A value of 0 = no adjustment. The number of degrees of angle increases as you increase value to maximum at 255 (100%).

Modifier 2: Adjusts the latitude (vertical) angle. A value of 0 = no adjustment. The number of degrees of angle increases as you increase value to maximum at 255 (100%).

Modifier 3: Adjusts the center of the latitude angle. A value of 128 = no adjustment and assumes the center of the latitude angle is at the “equator”. Values below the midpoint move the center of the latitude angle down with 0 = maximum distance below the “equator”. Values above the midpoint move the center of the latitude angle up to 255 = maximum distance above the “equator”.

NOTE: When the Spherical Mapping effect is selected in a Global Effect parameter and a Graphic Effect parameter's DMX value = 253, the Graphic Effect Modifier parameters make the following Spherical Mapping adjustments:

Modifier 1: Controls the vertical offset of the projector. A value of 128 = no adjustment. to maximum at 255 (100%). Values below the midpoint compress the grid toward the “equator”. Values above the midpoint stretch the horizontal grid lines away from the “equator”.

Modifier 2: Adjusts the vertical offset of the sphere. A DMX value of 128 (50%) = no adjustment. Adjusting toward 0 moves the center of the adjustment down toward the bottom of the image. Values above the midrange move the bend center up to the top of the image at a DMX value of 255 (100%).

Modifier 3: Adjusts to the size of the sphere. A DMX value of 64 (25%) = no adjustment. Adjusting toward 0 compresses the grid toward the vertical center. Values above the midrange stretch the grid toward the edges of the image at a DMX value of 255 (100%).

When the Spherical Mapping effect is selected in a Global Effect parameter and a Graphic Effect parameter's DMX value = 254, the Graphic Effect Modifier parameters make the following Spherical Mapping adjustments:

Modifier 1: Corrects the vertical bend. A value of 0 = no adjustment. Values below the midpoint bend the horizontal lines toward the "equator" to a maximum at 255.

Modifier 2: Adjusts the center of the vertical bend. A DMX value of 128 (50%) = no adjustment. Adjusting toward 0 moves the bend center down to the bottom of the image. Values above the midrange move the bend center up to the top of the image at a DMX value of 255 (100%).

Modifier 3: Adjusts the center of the horizontal bend. A DMX value of 64 (25%) = no adjustment. Adjusting toward 0 bends the vertical grid lines toward the center of the output. Values above the midrange bends the lines away from the vertical center to a maximum at 255 (100%).

TIP: Modifier channels for Effect Mode 1 are labeled as CMY in the Wholehog system so you can also make use of the color picker, HSI, and other Wholehog functions. Use the CMY parameter controls to adjust the three Effect Mode 1 Modifier parameters for both the Global and Graphic fixture types.

The default for Effect Mode 1 is set to CMY1 as well. Modifier channels for Effect Modes 2 and 3 are labeled Mod 1, Mod 2, and Mod 3.

Texture Mixing

Object Effect Global Effect

Effect Mode parameter DMX value = 51

Use Texture Mixing to mix two media file outputs on one object. With this effect, you can crossfade the texture (media file content) from one active Graphic Object to the texture of another Graphic Object. When the Texture Mixing effect is selected in the example to the right, the media file output of Graphic Object 1 (minus applied effects) is selected and mixed to Graphic Object 2 with opacity = 50%.

Modifier 1: Selects the Source file for the texture you want to pull. A DMX value = 1 selects the media content from Graphic Object 1, a value = 2 selects from Graphic Object 2, and a value = 3 selects from Graphic Object 3.

Modifier 2: Selects the effect level you want to use for the source file. A DMX value = 0 selects the original file without effects. If effects have been applied to the image, A DMX value = 1 includes the first applied effect; DMX = 2 includes the first two effects and DMX = 3 includes the first three effects.

Modifier 3: Adjusts Graphic Object opacity of the source texture from a DMX value of 0 = transparent to 255 (100%) = fully opaque.

TIP: Use the following steps create a modified Trails effect with the Texture Mixing effect:

1. Select two Graphic Objects. The second object can be a solid black screen (Media Folder 1, Media File 1)
2. Use Modifier 1 to select the Graphic Object you want to display with a trail effect.
3. Set Modifier 2 to a DMX Value = 2
4. Set Modifier 3 in a range between a DMX value of 240-254. The closer to 254, the more exaggerated the trail effect appears. If Modifier 3 is set to 255, the output will appear to stall or freeze on an image.

NOTE: This effect is also available as a Visual Mode adjusted with two Modifier parameters, (see Texture Mixing on page 100).

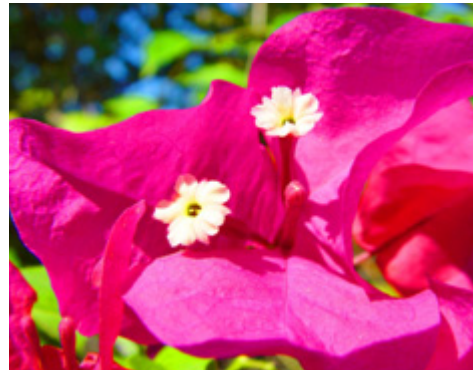

Graphic Object 1 Content

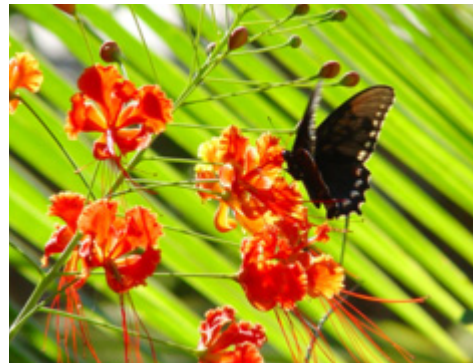

Graphic Object 2 Content

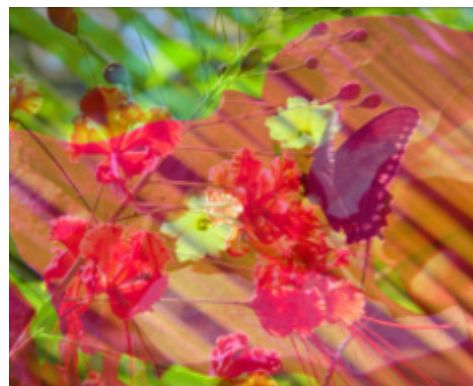

Effect Mode parameter DMX = 51
Modifier 1 parameter DMX = 1
Modifier 2 parameter DMX = 0
Modifier 3 parameter DMX = 128

Texture Ripple, Asymmetrical Circular

Object Effect Global Effect

Effect Mode parameter DMX value = 25

This effect varies the distance of reference points to the applied media file texture around the Z axis without affecting the underlying object to create an effect of wavy ripples moving out from the object's center.

Modifier 1: Adjusts the size (amplitude) of the ripple from 0 = no adjustment to 255 (100%) = maximum size.

Modifier 2: Adjusts the rate (frequency) of the ripple from 0 = no adjustment to 255 (100%) = maximum rate.

Modifier 3: Adjusts the offset (phase) speed and direction. A DMX value of 128 (50%) = no adjustment. DMX Values above the midpoint increase speed in a forward direction to 255 (100%) = fastest speed. DMX values below the midpoint increase speed in a backward direction from no adjustment to 0 = fastest speed.

Texture Ripple, Circular

Object Effect Global Effect

Effect Mode parameter DMX value = 24

This effect varies the distance of reference points to the applied media file texture around the Z axis without affecting the underlying object. This creates an effect of concentric rippling out from the object center.

Modifier 1: Adjusts the size (amplitude) of the ripple from 0 = no adjustment to 255 (100%) = maximum size.

Modifier 2: Adjusts the rate (frequency) of the ripple from 0 = no adjustment to 255 (100%) = maximum rate

Modifier 3: Adjusts the offset (phase) speed and direction. A DMX value of 128 (50%) = no adjustment. DMX Values above the midpoint increase speed in a forward direction to 255 (100%) = fastest speed. DMX values below the midpoint increase speed in a backward direction from no adjustment to 0 = fastest speed.

Texture Ripple, Horizontal

Object Effect Global Effect

Effect Mode parameter DMX value = 22

This effect varies the distance of reference points to the applied media file texture around the X axis without affecting the underlying object.

Modifier 1: Adjusts the size (amplitude) of the ripple from 0 = no adjustment to 255 (100%) = maximum size.

Modifier 2: Adjusts the rate (frequency) of the ripple from 0 = no adjustment to 255 (100%) = maximum rate.

Modifier 3: Adjusts the offset (phase) speed and direction. A DMX value of 128 (50%) = no adjustment. DMX Values above the midpoint increase speed in a forward direction to 255 (100%) = fastest speed. DMX values below the midpoint increase speed in a backward direction from no adjustment to 0 = fastest speed.

Texture Ripple, Vertical

Object Effect Global Effect

Effect Mode parameter DMX value = 23

This effect varies the distance of reference points to the applied media file texture around the Y axis without affecting the underlying object.

Modifier 1: Adjusts the size (amplitude) of the ripple from 0 = no adjustment to 255 (100%) = maximum size.

Modifier 2: Adjusts the rate (frequency) of the ripple from 0 = no adjustment to 255 (100%) = maximum rate

Modifier 3: Adjusts the offset (phase) speed and direction. A DMX value of 128 (50%) = no adjustment. DMX Values above the midpoint increase speed in a forward direction to 255 (100%) = fastest speed. DMX values below the midpoint increase speed in a backward direction from no adjustment to 0 = fastest speed.

Texture Shift

Object Effect Global Effect

Effect Mode parameter DMX value = 88

This effect creates offset image elements by shifting the texture based upon selected color values.

Modifier 1: Shifts the texture left to right

Modifier 2: Shifts the texture up to down

Modifier 3: Selects a color and scales the shift. Red and green color values (cyan) shift from 0 = maximum to 84 = a minimum shift. Red and blue color values (magenta) shift from 85 = maximum to 170 = a minimum shift. Green and blue color values (yellow) shift from a 171 = maximum to 255 = a minimum shift.

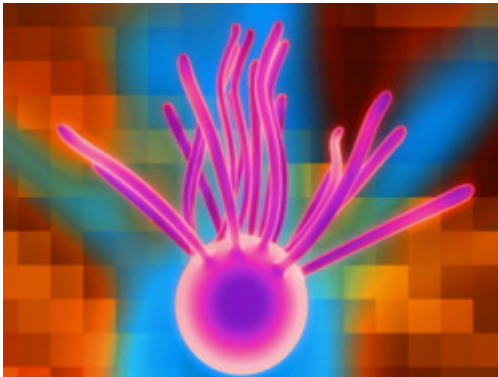

Original Content

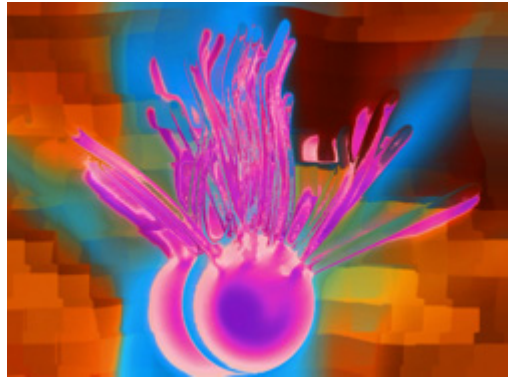

Modifier 1 parameter DMX = 24
Modifier 2 parameter DMX = 184
Modifier 3 parameter DMX = 18

Tiling On

Object Effect Global Effect

Effect Mode parameter DMX value = 48

Tiling varies the number of times a media file is applied as a texture to an object. This effect works best on objects that have an undisrupted surface area.

Modifier 1: Adjusts the size and number of tiles along the x axis. A value of 128 (50%) = no adjustment. Values below the midpoint size a single image to 0 = maximum image magnification. Values above the midpoint increase number of images displayed to 255 (100%) = maximum.

Modifier 2: Adjusts the size and number of tiles along the x axis. A value of 128 (50%) = no adjustment. Values below the midpoint size a single image to 0 = maximum image magnification. Values above the midpoint increase number of images displayed to 255 (100%) = maximum.

Modifier 3: Adjusts the spacing between tiles. Black spacing between tiles increases from a 0 = a minimum width to 127 = a maximum width. Transparent spacing between tiles increases from 128 = a minimum width to 255 = a maximum width.

NOTE: *The Tiling effect implemented on Effect 1 overrides tiling on both Effect 2 and Effect 3.*

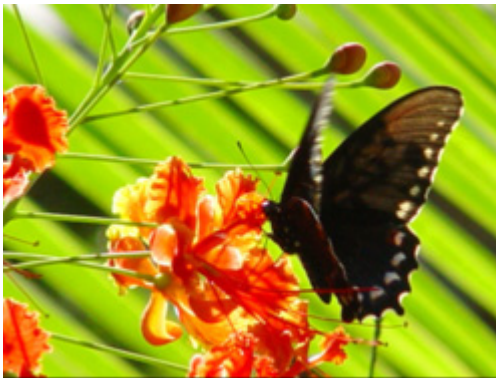

Original Content

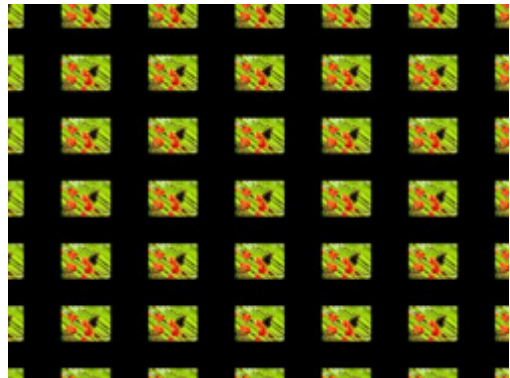

Modifier 1 parameter DMX = 251

Modifier 2 parameter DMX = 255

Modifier 3 parameter DMX = 97

Transparent Wipes

Object Effect Global Effect

Effect Mode parameter DMX value = 33

Transparent wipes let you open one graphic to reveal another graphic behind it. You can select from six options and the centerline of the effect.

Modifier 1: Adjusts the area of the wipe from the smallest at a value of 0 to the largest at a value of 255 (100%).

Modifier 2: Selects the center of a wipe effect's separation

Modifier 3: Selects the wipe option. Each option occupies a portion of the DMX value range (see table at right).

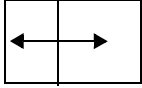
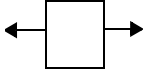
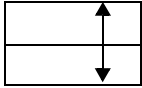
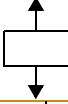
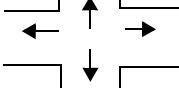
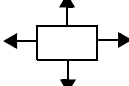
DMX Value	Modifier 3: Wipe Option	
1-42	Rectangle wipes from center out horizontally	
43-84	Rectangle wipes from edges out horizontally	
85-126	Wipes from center out vertically	
127-170	Wipes from edges out vertically	
171-212	Cross shape wipes from center out	
212-255	Box shape wipes from edges outward	

Zoom Blur

Object Effect Global Effect

Effect Mode parameter DMX value = 59

Zooms into a position on the image with a multi-image blurring effect. You can control the position of the zoom center on the image.

Modifier 1: The default DMX value of 128 (50%) = no adjustment. Values below the midpoint move the horizontal center of the zoom right to 0 = maximum. Values above the midpoint move the horizontal center of the zoom left to 255 = maximum.

Modifier 2: The default DMX value of 128 (50%) = no adjustment. Values below the midpoint move the vertical center of the zoom down as you approach 0 = maximum. Values above the midpoint move the vertical center of the zoom up to 255 (100%) = maximum.

Modifier 3: The default DMX value of 128 (50%) = no adjustment. Values below the midpoint zoom in to the image centerpoint to 0 = maximum image size. Values above the midpoint zoom away from the image centerpoint to 255 = a minimum image size.

NOTE: *This effect is also available as a Visual Mode adjusted with 2 Modifier parameters, (see Zoom Blur on page 101).*



Original Content



Modifier 1 parameter DMX = 128
Modifier 2 parameter DMX = 128
Modifier 3 parameter DMX = 255

Chapter 14:

Fixture Motion Functions

This chapter describes mechanical movement control for DL.3 and DL.2 fixtures.

Pan and Tilt

DL.3 and DL.2 fixtures have a 400° pan range and a 240° tilt range. Two DMX channels for **Pan** and two for **Tilt** provide 16-bit position adjustment to a fraction of a degree.

MSpeed values can control the timing of pan and tilt motion for DL.3 and DL.2 fixtures, (see *MSpeed (Motor Speed)* on page 238). To control Pan and Tilt movement timing via a DMX controller crossfading, leave the Pan/Tilt MSpeed in its default Off setting.

NOTE: *DL.3 and DL.2 fixtures use optical encoders for pan and tilt to instantly correct the fixture's position if the fixture is jarred from its programmed position.*

If a physical obstruction prevents the fixture from correcting its position, this correction feature "times out" to prevent wear on the motors.

If the fixture's position correction has timed out, remove the obstruction and home the fixture to return it to normal operation.

Dimmer

DL.3 and DL.2 fixtures have a mechanical iris located in front of the projector output lens that functions as a dimmer for the fixture's output. This feature gives the operator the ability to fully shutter the output and eliminate the residual luminance from video black. The **Dimmer** parameter controls the dimming iris adjustment from closed (DMX value = 0) to fully open (DMX value = 255).

Focus

The **Focus** parameter controls the fixture's mechanical focus from near (DMX value = 0) to far (DMX value = 255).

Zoom

This **Zoom** parameter controls the fixture's mechanical zoom from narrow (DMX value = 0) to wide (DMX value = 255).

MSpeed (Motor Speed)

The **MSpeed** parameter adjusts the time required for a motor to complete movement when changing from one position to another. MSpeed provides a method for all motors to reach their target position at the same time, even though each motor may have different distances to travel. MSpeed movement is extremely smooth because the fixture controls movements independent of DMX refresh rates.

MSpeed times vary from 0.15 seconds to 252.7 seconds. In general, allowing the console to crossfade the pan and tilt values for a DL.3 or DL.2 fixture is acceptable. However, extremely slow movements may require the use of MSpeed instead of console crossfades. For a listing of exact MSpeed times, see “Appendix B: MSpeed Conversion Table”.

Control Function Options

The **Control** parameter remotely initiates various fixture operations and allows access to the internal-projector menu controls.

Fixture Operations

NOTE: *All of the following Fixture operation Control parameter settings (except for MSpeed Off), require the Dimmer be closed (DMX Value = 0).*

DMX Value Range	Control Option Description
10-13	Disables Pan and Tilt MSpeed
20-28	Disables the LCD Display
30-38	Dims the LCD display
40-48	Enables the LCD display
50-58	Enables Preview Mode for the LCD display
60-68	Homes all the fixture mechanical functions
80-88	Manually turns the Lamp ON
90-98	Manually turns the Lamp OFF
120-130	Shuts down the fixture
145-149	Resets the Graphics Engine
150-155	Resets the Camera functions
160-168	Homes only the Pan and Tilt functions
170-178	Homes only the Focus, Zoom, and Dimmer components

Projector Control

Control Parameter Projector Options

These **Control** parameter options remotely access and operate the internal projector's menu system.

Control Option Description	
Displays the Projector's internal Menu System	
Projector Up arrow	<p>NOTE: These options control the directional buttons on the projector menu display and cannot be activated until you set the Dimmer parameter to 0.</p>
Projector Down arrow	
Projector Left arrow	
Projector Right arrow	
Store Menu selection	
The following options are always active and do not require the dimmer to be at zero	
Projector Floor Orientation	These commands activate the projector's setting for specific mounting or projection alternatives.
Projector Ceiling Orientation	Once set, these commands maintain their value until reset even after shutdown and re-homing. For example, if the Control parameter is set to switch the unit to Ceiling orientation, then the unit will remain in Ceiling orientation until another command is sent to switch back to Floor. This allows the Control parameter to revert to another value without losing the orientation or mirroring status.
Projector Front Projection	Once set, these commands maintain their value until reset even after shutdown and re-homing. For example, if the Control parameter is set to switch the unit to Ceiling orientation, then the unit will remain in Ceiling orientation until another command is sent to switch back to Floor. This allows the Control parameter to revert to another value without losing the orientation or mirroring status.
Projector Rear Projection	
Input from External RGBHV to Projector	Video input can be utilized with either RGBHV or VGA but not both. You can select between RGBHV and VGA in the menu system, (see <i>DMX_Control Screen</i> on page 28). RGBHV is the factory default.
Graphics Engine to Projector	Before using DMX to change DL.3 or DL.2 inputs, you must enable the Projector Input by DMX option in the menu system (see <i>Set_Projector Screen</i> on page 32) or through the CMA (see <i>DL.3 and DL.2 Media Server Configuration Options</i> on page 276). Once the selection is made, allow about 10 seconds for the change to take effect.
Input from S-Video In (camera to Camera Out) to Graphics Engine	
Input from Camera to Graphics Engine (default)	
The following options require the dimmer to be at zero	
Lens Shift Engaged	Mechanically offsets the projector lens 107% vertically (available for DL.3 fixtures only).
Lens Shift Off	Centers the image on the fixture (available for DL.3 fixtures only).
The following options do not require the dimmer to be at zero	
SDI Output mode	Routes the internal camera feed to the SDI card for output to another DL.3 fixture for projection after the Input from Camera to Graphics Engine has been selected.
SDI Input mode	Routes the SDI input to the capture card.



CAUTION:

Do not physically connect both the VGA and the RGBHV connectors at the same time. Doing so can damage the projector and void the warranty.

Using the Internal Projector's Menu

To use the native projector menu system under DMX control:

1. Set the Dimmer parameter DMX value to zero.
2. Set the Control parameter DMX value to 182. This will access the projector's main menu.
3. Next, change the DMX value of the Control panel to zero. This command is equivalent to releasing the key on the projector's keypad. *Failure to release the key will result in unpredictable performance.*
Optional. If the projector is mounted on the ceiling, flip the display by selecting a Control parameter DMX value from 209-212.
4. Set the Dimmer parameter DMX value to 255 (100%) to view the projector menu's on-screen display.
5. Adjust the Zoom and Focus parameters to bring the display into focus. Now the control parameter's *Projector Floor Orientation*, *Projector Ceiling Orientation*, *Projector Front Projection* and *Projector Rear Projection* commands map to the Projector's menu control buttons.
6. Use the projector's on-screen display as discussed in the projector's user manual that shipped with your DL.3 fixture.

Chapter 15:

Live Video Input and Control

The graphics engine in a DL.2 fixture can receive video from an external source or its own integrated digital video camera equipped with an infrared illuminator to provide a direct digital video feed option.

Live Video Sources

Internal Camera

Every DL.2 fixture is equipped with a internal video camera and IR illuminator capable of capturing live video even in blackout conditions.

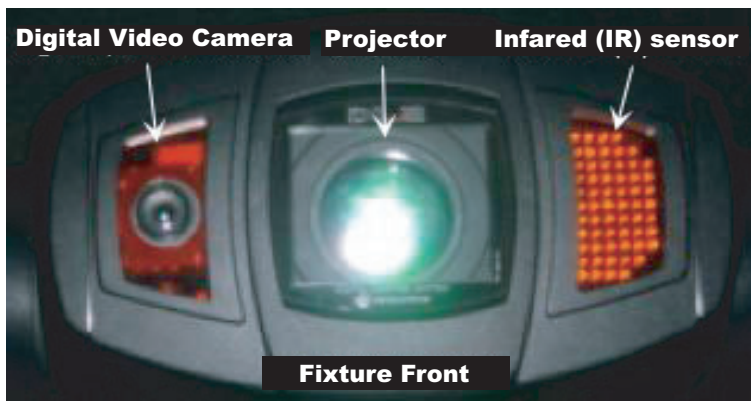

The camera is mounted on the front of the unit near the projector iris to point wherever the fixture is directed.

All of the camera functions can be controlled via a DMX console (see *Controlling the Internal Camera Input* on page 243).

Other Video Sources

A DL.2 fixture can also project other live video sources connected to the DL.2 fixture's RGBHV, VGA, or S-Video input ports. With S-Video input, the live video can be further enhanced and manipulated by the DL.2's graphics engine.

Note: *You can configure the graphics engine to capture video from an external source or the internal camera but not from both at the same time.*

Live Video Connection Options

The DL.2 fixture has video connectors for RGBHV, VGA and S-Video on its rear panel, as shown in the following figure.

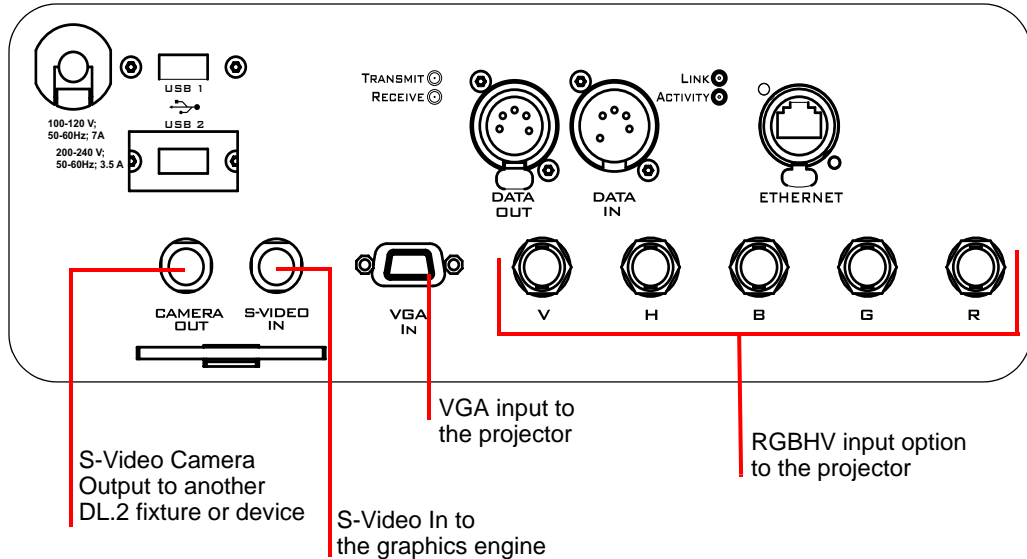

CAUTION:
To avoid damaging the fixture and voiding the warranty, do not physically connect to the RGBHV and VGA inputs at the same time.

Configuring the Video Input Source

DL.2 fixtures support multiple SVideo formats including:

NTSC_M	PAL_B	PAL_H	SECAM_B	SECAM_K
NTSC_MJ	PAL_D	PAL_I	SECAM_D	SECAM_K1
	PAL_G	PAL_M	SECAM_G	SECAM_L
		PAL_N	SECAM_H	SECAM_L1

You will need to configure the DL.2 fixture to identify which video input source you have chosen. The active input can be configured the following ways:

- Manually using the DL.2 menu system (see information about the *Projector Input* field on the *Set_Projector Screen* on page 32.)
- Remotely through the CMA (see *DL.3 and DL.2 Media Server Configuration Options* on page 276).
- Via the DMX console commands (see *Projector Control* on page 239).

NOTE: The integrated camera provides an NTSC_M video signal.

Sending the Camera Feed to Camera Out

The factory default assigns the video feed from the internal camera to the graphics engine. However, a DL.3 or DL.2 fixture can be configured to route the camera video feed to the Camera Out connector by setting the Control Parameter to a DMX value between 229-232.

NOTE: *The internal camera video feed can be routed to either the graphic engine or the camera out connector, it can not be applied to both at the same time.*

This setting will be retained until you change it or restore the factory defaults.

Controlling the Internal Camera Input

Several parameters allow you to control and apply effects to the Internal camera input.

Camera Zoom

The **Camera Zoom** parameter uses two DMX channels to provide 16-bit control of the camera's zoom function. This includes an 18× optical and 12× digital zoom for a total of 216× combined zoom range. You can adjust the Camera Zoom parameter from In (DMX value = 0) to Out (DMX value = 65535)

Camera Focus

The **Camera Focus** parameter uses two DMX channels to provide 16-bit control of the camera's focus function. Auto focus for the camera is active when DMX values = 0–511. The camera focus can also be manually adjusted from In (Far End) DMX value = 512 to Out (Near End) DMX value = 65535.

IR Illuminator

The DL.2 fixture is equipped with an illuminator that can output infrared (IR) light. The **IR Illuminator** parameter controls both the IR illuminator output and the camera's infrared sensing option. DMX values = 0 – 63 turn the illuminator off and set the camera to sense the visible light spectrum. From DMX values = 64–127, the illuminator remains off, but the camera's Auto IR function is ON, detecting ambient infrared light in the environment. The rest of the DMX range turns the Auto adjustment off and adjusts the amount of IR illuminator output from FULL (DMX value = 128) to OFF (DMX value = 255).

Camera Shutter

The DL.2 fixture's internal camera can create slow-motion and choppy-frame effects using the camera shutter options. The **Camera Shutter** parameter controls the camera shutter providing six steps of frame rate control from 1 to 30 frames/second. DMX values = 0 – 63 set Full Auto Exposure and is the suggested default option.

White Balance Mode

The **White Balance Mode** parameter adjusts for variation in what is perceived as “White” in different light conditions. The Auto White Balance mode computes the white balance value output using color information from the entire image. It outputs the proper value using the color temperature on a range of values from 3000 to 7500K and is the suggested default setting. Other settings for this parameter accommodate Indoor and Outdoor lighting conditions.

Orientation

The **Camera Orientation** parameter can Vertically Invert (Flip) or Horizontally Invert (Mirror) the camera’s image being viewed by the camera. All four combinations of Vertical and Horizontal Invert are available.

Camera Effects

The **Camera Effects** parameter provides several options for manipulating the camera’s image. This parameter provides the ability to convert the camera’s image to black and white (B&W), or invert the color (Negative art). A snapshot can also be taken of the camera’s image (Freeze Frame) with or without one of these effects applied.

Chapter 16: Content Management Application (CMA)

A Content Management Application (CMA) running on an Axon media server or a computer connected through an Ethernet network gives you remote control of content, software and configuration management functions.

The CMA software that shipped on CD with your DL.3, DL.2 or Axon media server is used to:

- Upload and download custom digital content to fixtures
- Configure units to use in a DMX environment
- Update software for multiple units

The CMA can access all media servers connected to the same Ethernet network.

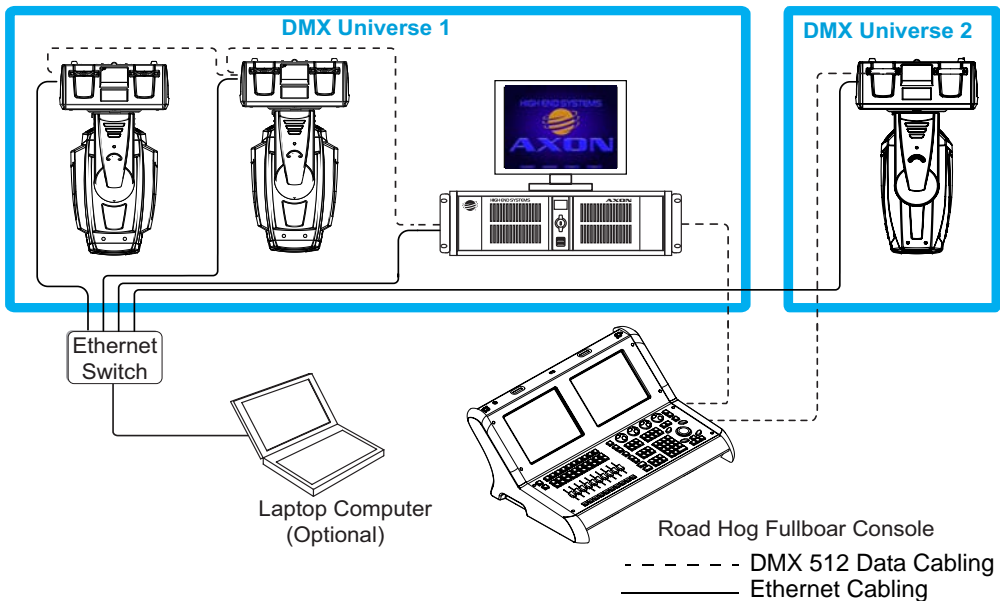

NOTE: *If you are using a DMX console and other automated lighting products compatible with Art-Net, this network can also serve as the link for DMX control.*

Launching the CMA

Installing the CMA on Your Computer

You can download the latest version of the application from the Digital Lighting support section of the High End Systems website www.highend.com/support/digital_lighting/. A download wizard simplifies installation on your personal computer.

The following are the recommended software requirements for running the CMA:

- Windows XP, Vista, Windows 7 (32 and 64 bit) or Mac OS 10.6 or later
- Microsoft .Net 2
- 100/1000 base Ethernet card (a Gigabit Ethernet card is recommended for fast content uploading of large files)

To automatically install the CMA on your computer's hard drive, insert the CD that shipped with your media server.

NOTE: *If you are running Windows OS and the CMA doesn't automatically install, navigate to the CMA.msi file in your windows browser and double click to install the CMA.*

Once the CMA is installed, double clicking on the application icon will launch it and display the CMA Client Window.

Launching the CMA on Axon

Axon media servers can launch the CMA locally. When you start Axon, the local monitor will display a desktop that gives you access to the CMA.



NOTE: *An active display device must be attached to both DVI ports before booting up the system. When only one port is connected, it defaults to display the graphics engine output and will not display the CMA screen.*

Press the **Launch CMA** button on the local desktop. The application automatically finds and identifies the **Local Drives** including any connected USB drives, the CD/DVD drive as well as other Axon, DL.3 and DL.2 media servers connected to the same Ethernet network.

NOTE: *The Axon server supports an onboard DVD drive you can use for copying content into an Axon Server as well as burning User content onto DVD/CD.*

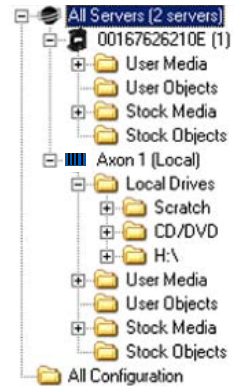

Auto Discovery

When a DL.3, DL.2 fixture or Axon media server is connected to an ethernet network, it sends out “Discovery” messages. These messages are received by other media servers on the link as well as the CMA software. The messages contain information that allows the media servers to communicate with each other, and the CMA to communicate with all the units on the network.

The CMA window will display the IP Address, Fixture ID, the Media Server software version and the server model. Fixtures derive their IP addresses through a router or automatic IP assignment.

Fixture Identification

The Fixture ID is a unique number used in the control protocol to identify specific fixtures for synchronization functions. For more information on Synchronization content playback, see *Chapter 10: Graphic Functions: Synchronizing Content* on page 107.

NOTE: *To ensure that synchronization works properly, each DL.3, DL.2 or Axon media server should be assigned a unique fixture ID.*

The CMA Client Window

The CMA Client Window provides views of the content and configuration for all DL.3, DL.2 and Axon servers connected to the Ethernet network in the Left pane. Information is displayed in the right pane for any item selected. Access options through the menus at the top of the window or by right clicking in the right pane.

NOTE: *You cannot drag folders or files between the left and right panes of the CMA window.*

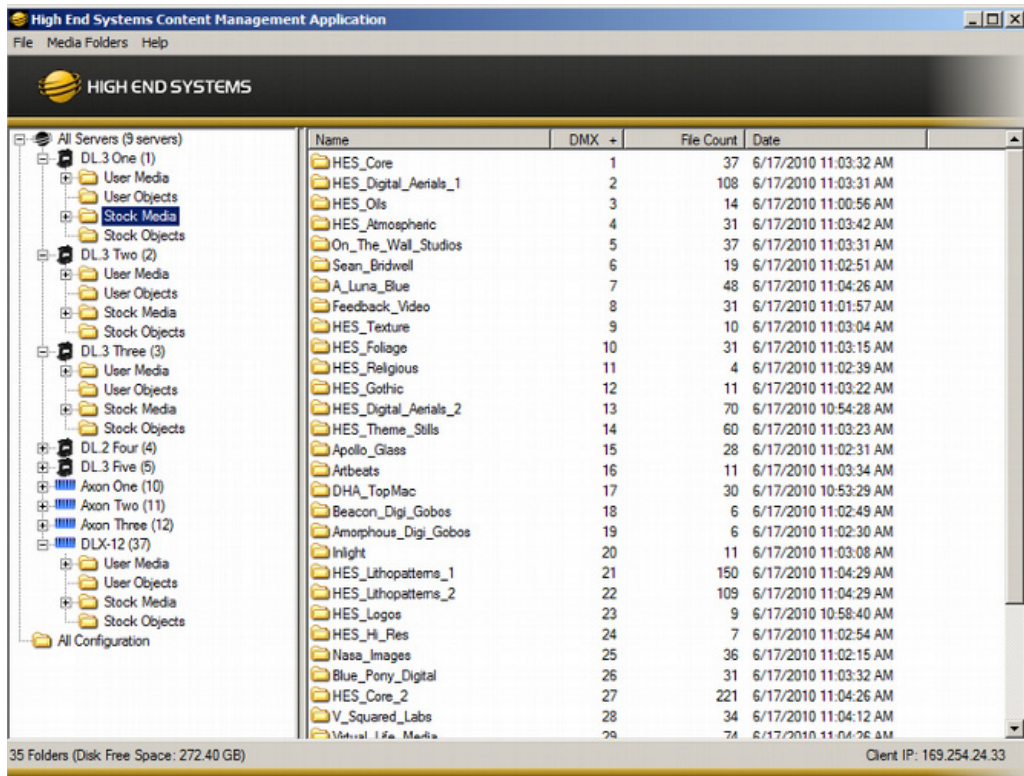

A **Status Bar** at the bottom of the page, indicates the number of files or folders in a selected folder in the left pane, as well as free space on the local computer hard drive and its IP address.

Viewing Server Identification Information

Selecting the **All Server** view displays all the Digital Light fixtures and Axon servers on the fixture network. In the following example, six servers have been identified on the network. The right pane contains the following details in a table format.

- **Server ID** number defaults to 1, but can be configured in the CMA or in the DL.3 or DL.2 fixture's Menu system
- **Server Name** is a name you assign to a Digital Light fixture or Axon server
- **IP Address** is assigned to that unit by the router or Auto IP
- **Software Version** Number
- **Model** identifies the media server as a DL.3, DL.2 or Axon

The screenshot shows the 'High End Systems Content Management Application' window. The left pane displays a tree view of servers under 'All Servers (8 servers)'. The right pane shows a table with the following data:

Server ID	Server Name	IP Address	Software Version +	Model
2	DL.3 Two	169.254.11.144	2.0.0.2385	DL3
11	Axon one	169.254.150.81	2.0.0.2385	Axon
14	Axon Four	169.254.122.38	2.0.0.2385	Axon
12	Axon Two	169.254.179.247	2.0.0.2385	Axon
1	DL.3 One	169.254.153.131	2.0.0.2385	DL3
5	DL.3 Five	169.254.60.53	2.0.0.2385	DL3
3	DL.3 Three	169.254.112.58	2.0.0.2385	DL3
13	Axon three	169.254.249.89	2.0.0.2385	Axon

A context menu is open over the row for Server ID 13, showing options: Refresh, Clone Content, Delete Content, Create Content Archive, Deploy Content Archive, Upgrade Software, DMX Summary, Download Log, and Identify.

NOTE: Clicking in a column heading sorts the table according to the values in that column.

In the **All Server** view, the drop down **Servers** menu or right clicking to select a server in the right pane gives you the these options:

- **Refresh** the screen.
- **Clone Content** replicates the server's user content to one or more other servers on the network, (see page 267).

- **Delete Content** removes all the user content from the server.
- **Create Content Archive** lets you back up all the server's user content to a compressed file, (see page 266).
- **Deploy Content Archive** restores user content to the server from the backup, (see page 266).
- **Upgrade Software** allows you to upgrade fixture software. For more information on upgrade options, see *Upgrading Software* on page 270.
- **DMX Summary** provides a web-based summary of a server's content in a table format.
- **Download Log** provides useful troubleshooting information to Customer Service if needed.
- **Identify** will cause a fixture to strobe, so you can find it in the rig.

Content Organization

The media server on each fixture has a file system that holds the movies, images, and 3-D objects that make up the content that the server uses.

These files, folders, and their DMX values are collectively known as the "Content" on the media server.

The CMA Client Window organizes and identifies content by source (preloaded Stock content or custom User content) and type (Media files or 3-D Object files).

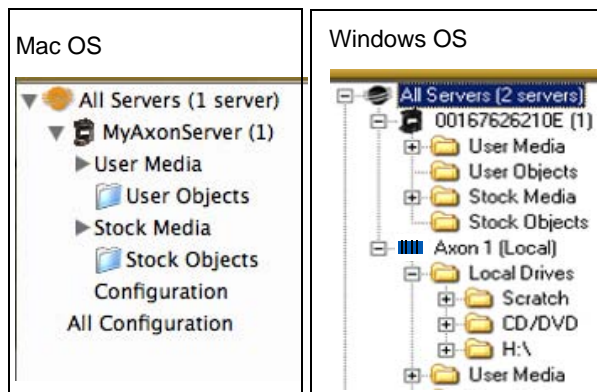

NOTE: *Tree structure differs slightly on the two platform versions. In the Mac version, to access Server Configuration information for an individual server, select the Configuration option under the individual server. In Windows Explorer, configuration information for the server is located directly by selecting the server.*

Preloaded Stock Content

A large library of **Stock Media** and **Stock Objects** ships on every DL.3, DL.2 or Axon media server and will also be provided through upgrades from High End Systems.

NOTE: *The DL.3 fixture ships with an additional 400+ files of media content, many in higher resolution.*

This content is read only. You won't be able to download, edit the DMX values or remove these files from the fixture.

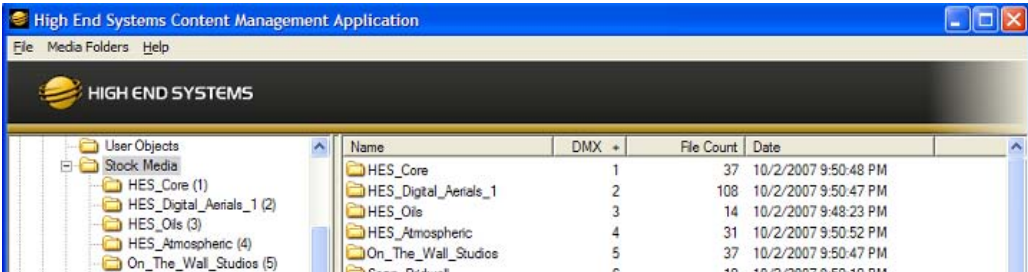

Custom User Content

You can create your own custom User Media and User Objects content, and upload it to media servers. The Stock Content and User Content reside in separate folders. The High End Systems Digital Lighting Community (forums.highend.com) is a resource for tips and techniques on creating User Content. See *Custom User Content* on page 347 for basic considerations in developing your own content for Axon or Digital Light media servers.

Media Files

Inside **User Image** and **Stock Image** folders are Library folders containing collections of media files. Media files can be still images or video clips in one of the following formats:

.jpg	.gif	.png	.bmp	.mpv	.m1v	.mpg	.m2v
------	------	------	------	------	------	------	------

NOTE: *Axon and Digital Light media servers supports .jpg formatted using RGB color. CMYK color files are not currently supported.*

The screenshot shows the 'High End Systems Content Management Application' window. On the left is a file tree under 'All Servers (3 servers)' with a selected folder 'DL_3 One (1)'. The main area displays a table of media files with the following columns: Name, Type, DMX, Size, Width, Height, Frame Count, Frame Rate, and Movie Length.

Name	Type	DMX	Size	Width	Height	Frame Count	Frame Rate	Movie Length
Ball-Churn-HD.mpg	mpg	1	33,335 KB	1024	768	417	30	0:13.90
Beach-Waves-HD.mpg	mpg	2	68,359 KB	1024	768	840	30	0:28.0
Blob-Holes-HD.mpg	mpg	3	56,249 KB	1024	768	768	30	0:25.60
Breading-Bullets-HD.mpg	mpg	4	78,125 KB	1024	768	960	30	0:32.0
Bubble-Texture-HD.mpg	mpg	5	29,297 KB	1024	768	360	30	0:12.0
Bubbles-Rapid.mpg	mpg	6	29,296 KB	768	576	480	30	0:16.0
Bubbles.mpg	mpg	7	23,437 KB	640	480	480	30	0:16.0
Bubblescape-HD.mpg	mpg	8	48,930 KB	1024	768	481	24	0:20.4
Color-Sine-HD.mpg	mpg	9	21,972 KB	1024	768	300	30	0:10.0
Colored-Crust-HD.mpg	mpg	10	75,368 KB	1024	768	926	30	0:30.86
Controls-HD.mpg	mpg	11	27,992 KB	1024	768	344	30	0:11.46
Deep-Down.mpg	mpg	12	87,890 KB	640	480	1800	30	1:0.0
Digital-Multi-Color-HD.mpg	mpg	13	93,925 KB	1024	768	1127	30	0:37.56
Digital-Sine-HD.mpg	mpg	14	24,414 KB	1024	768	300	30	0:10.0
Disco-Ball.mpg	mpg	15	17,578 KB	640	480	360	30	0:12.0
Dunes-HD.mpg	mpg	16	93,751 KB	1024	768	1152	30	0:38.40
Dust-Dial-HD.mpg	mpg	17	78,287 KB	1024	768	962	30	0:32.6
Explosion.mpg	mpg	18	2,999 KB	640	480	62	30	0:2.6
Eye-Cultures-Fades-HD.mpg	mpg	19	34,863 KB	800	600	504	30	0:16.80
Fast-Car-Commute.mpg	mpg	20	187,255 KB	640	480	3540	30	1:58.0
Flip-Clock-HD.mpg	mpg	21	3,665 KB	1024	768	53	30	0:1.76
Flow-Swirls.mpg	mpg	22	50,260 KB	800	600	772	30	0:25.73
Flower-Fly-Though-HD.mpg	mpg	23	39,063 KB	800	600	480	30	0:16.0
Foliage-And-Flowers-HD.mpg	mpg	24	13,672 KB	1024	768	168	30	0:5.60
Gibson-Guitar-HD.mpg	mpg	25	106,099 KB	1024	768	1105	24	0:46.4
Graty-DJ-HD.mpg	mpg	26	45,702 KB	1024	768	624	30	0:20.80
Grassy-Field-Fly-By-HD.mpg	mpg	27	32,961 KB	800	600	405	30	0:13.50
Green-Glass-HD.mpg	mpg	28	67,015 KB	1024	768	732	24	0:30.50
Hour-Glass-HD.mpg	mpg	29	48,827 KB	1440	1024	600	30	0:20.0
Hydro-Pump-HD.mpg	mpg	30	44,127 KB	1024	768	482	24	0:20.8
Icebergs-HD.mpg	mpg	31	78,124 KB	1024	768	960	30	0:32.0

The stock media files provided by High End Systems have been compressed and optimized for reliable and smooth playback from DL.3, DL.2 and Axon media servers. Each file and folder has an associated DMX value. These values are fixed for Stock Content but must be assigned for all user created content. See *Assigning DMX Values to User Content* on page 256 for more information.

Object Files

Object files are the 3-D object component files used to build a graphic image. DL.3, DL.2 and Axon protocol supports a combined total of 255 object files displayed in **Stock Objects** and **User Objects** folders. As with **Stock Media** files, the **Stock Objects** have a fixed DMX value and cannot be edited. A user-created object file must be assigned a unique DMX value between 150-255.

Viewing Server Configuration Data

Selecting an individual server from the list in the left pane displays all the configuration values for that server in the right pane. Selecting **All Configuration** displays the combined configuration values for all the servers on the network. For more information on server configuration, see *Viewing Server Configuration* on page 272.



Mac OS X: Viewing Server Configuration

To access Server Configuration information for an individual server, select the Configuration option under the individual server.

Viewing Content

You can view information about media folders and files within each folder in a table format.

NOTE: Clicking on a column heading sorts the table according to the values in that column.

Name	DMX +	File Count	Date
HES_Core	1	37	10/2/2007 9:50:48 PM
HES_Digital_Aerials_1	2	108	10/2/2007 9:50:47 PM
HES_Oils	3	14	10/2/2007 9:48:23 PM
HES_Atmospheric	4	31	10/2/2007 9:50:52 PM
On_The_Wall_Studios	5	37	10/2/2007 9:50:47 PM
Sean_Bridwell	6	19	10/2/2007 9:50:10 PM
A_Luna_Blue	7	48	10/2/2007 9:50:53 PM
Feedback_Video	8	31	10/2/2007 9:49:22 PM
HES_Texture	9	10	10/2/2007 9:50:27 PM
HES_Foliage	10	31	10/2/2007 9:50:36 PM
HES_Religious	11	4	10/2/2007 9:50:00 PM
HES_Gothic	12	11	10/2/2007 9:50:36 PM
HES_Digital_Aerials_2	13	70	10/2/2007 9:44:02 PM
HES_Theme_Stills	14	60	10/2/2007 9:50:38 PM
Apollo_Glass	15	28	10/2/2007 9:49:54 PM
Artbeats	16	6	10/2/2007 9:50:51 PM
DHA_TopMac	17	30	10/2/2007 9:43:06 PM
Beacon_Digi_Gobos	18	6	10/2/2007 9:50:08 PM
Amorphous_Digi_Gobos	19	6	10/2/2007 9:49:52 PM
Inlight	20	11	10/2/2007 9:50:32 PM

Viewing Folders

- **Name** of the Media File collection. This value is editable for User content. See *Naming and Deleting User Content Files and Folders* on page 256.
- **DMX** is the currently assigned DMX value for the folder. This value can be auto-assigned and edited for User content. See *Editing User Content DMX Values* on page 257.
- **File Count** of files in this collection
- **Date** the folder was last modified

Viewing Files

Double clicking on a media folder in the left pane reveals information about its content files.

The screenshot shows the 'High End Systems Content Management Application' interface. The left pane displays a tree view of servers and folders. The main pane shows a list of media files with the following columns: Name, Type, DMX, Size, Width, Height, Frame Count, Frame Rate, Movie Length, Has Sound?, and Date. The files listed include various HD and SD content such as 'Ball-ChurnHD.mpg', 'Beach-WavesHD.mpg', 'Bkbb-HolesHD.mpg', etc.

Name	Type	DMX	Size	Width	Height	Frame Count	Frame Rate	Movie Length	Has Sound?	Date
Ball-ChurnHD.mpg	mpg	1	33,395 KB	1024	768	417	30	0:13.90	no	2/19/2008 6:26:04 PM
Beach-WavesHD.mpg	mpg	2	68,269 KB	1024	768	840	30	0:28.0	no	2/19/2008 6:26:11 PM
Bkbb-HolesHD.mpg	mpg	3	56,249 KB	1024	768	768	30	0:25.60	no	2/19/2008 6:27:04 PM
BreedingBulletsHD.mpg	mpg	4	78,125 KB	1024	768	960	30	0:32.0	no	2/19/2008 6:27:15 PM
Bubble-TextureHD.mpg	mpg	5	29,297 KB	1024	768	360	30	0:12.0	no	2/19/2008 6:27:18 PM
Bubbles-Rapid.mpg	mpg	6	23,296 KB	768	576	480	30	0:16.0	no	2/19/2008 6:27:21 PM
Bubbles.mpg	mpg	7	23,837 KB	640	480	480	30	0:16.0	no	2/19/2008 6:27:26 PM
BubblescapeHD.mpg	mpg	8	48,590 KB	1024	768	481	24	0:20.4	no	2/19/2008 6:27:43 PM
Color-SineHD.mpg	mpg	9	21,572 KB	1024	768	300	30	0:10.0	no	2/19/2008 6:27:46 PM
Control-CrustHD.mpg	mpg	10	75,358 KB	1024	768	926	30	0:30.86	no	2/19/2008 6:27:55 PM
ControlsHD.mpg	mpg	11	27,982 KB	1024	768	344	30	0:11.46	no	2/19/2008 6:27:58 PM
Deep-Down.mpg	mpg	12	87,890 KB	640	480	1800	30	1:0.0	no	2/19/2008 6:31:44 PM
Digital-Multi-ColorHD.mpg	mpg	13	93,325 KB	1024	768	1127	30	0:37.56	no	2/19/2008 6:31:51 PM
Digital-SineHD.mpg	mpg	14	24,414 KB	1024	768	300	30	0:10.0	no	2/19/2008 6:31:54 PM
DiscoBall.mpg	mpg	15	17,578 KB	640	480	360	30	0:12.0	no	2/19/2008 6:31:56 PM
DunesHD.mpg	mpg	16	93,751 KB	1024	768	1152	30	0:38.40	no	2/19/2008 6:32:49 PM
Dust-DialHD.mpg	mpg	17	78,287 KB	1024	768	962	30	0:32.6	no	2/19/2008 6:46:23 PM
Explosion.mpg	mpg	18	2,989 KB	640	480	62	30	0:2.6	no	2/19/2008 6:32:54 PM
Eye-Cultures-FadesHD.mpg	mpg	19	34,863 KB	800	600	504	30	0:16.80	no	2/19/2008 6:32:57 PM
Fast-Car-Commute.mpg	mpg	20	187,255 KB	640	480	3540	30	1:58.0	no	2/19/2008 6:33:13 PM
Fip-ClickHD.mpg	mpg	21	3,665 KB	1024	768	53	30	0:1.76	no	2/19/2008 6:33:21 PM
Flow-Swirls.mpg	mpg	22	50,280 KB	800	600	772	30	0:25.73	no	2/19/2008 6:33:27 PM
Flower-Fly-ThroughHD.mpg	mpg	23	39,063 KB	800	600	480	30	0:16.0	no	2/19/2008 6:33:31 PM
Foliage-And-FlowersHD.mpg	mpg	24	13,672 KB	1024	768	168	30	0:5.60	no	2/19/2008 6:33:32 PM
Gibson-GuitarHD.mpg	mpg	25	106,089 KB	1024	768	1105	24	0:46.4	no	2/19/2008 6:33:44 PM
Grafx-DJHD.mpg	mpg	26	45,702 KB	1024	768	624	30	0:20.80	no	2/19/2008 6:33:49 PM
Grassy-Field-Fly-ByHD.mpg	mpg	27	32,261 KB	800	600	405	30	0:13.50	no	2/19/2008 6:33:52 PM
Green-GlassHD.mpg	mpg	28	67,016 KB	1024	768	732	24	0:30.50	no	2/19/2008 6:34:14 PM
Hour-GlassHD.mpg	mpg	29	48,827 KB	1440	1024	600	30	0:20.0	no	2/19/2008 6:34:19 PM
Hydro-PumpHD.mpg	mpg	30	44,127 KB	1024	768	482	24	0:20.8	no	2/19/2008 6:34:26 PM
IcebergsHD.mpg	mpg	31	78,124 KB	1024	768	960	30	0:32.0	no	2/19/2008 6:34:34 PM

- **Name** of the file. This value is editable for User content. See *Naming and Deleting User Content Files and Folders* on page 256.
- **Type** indicates the file format extension
- **DMX** is the currently assigned DMX value for the folder. This value can be auto-assigned and edited for User content. See *Assigning DMX Values to User Content* on page 256.
- **Size** of file in kilobytes
- **Width** in pixels
- **Height** in pixels
- **Frame Count**
- **Frame Rate** in frames per second
- **Movie Length** in hr.min.sec
- **Has Sound?** - Indicates whether or not the movie file has sound data encoded into it. This should always say "no" if the content is encoded correctly.
- **Date** the file was last modified

You can access several options for displaying files in the right pane through the drop down menu or by right clicking in the right pane when files are being displayed.

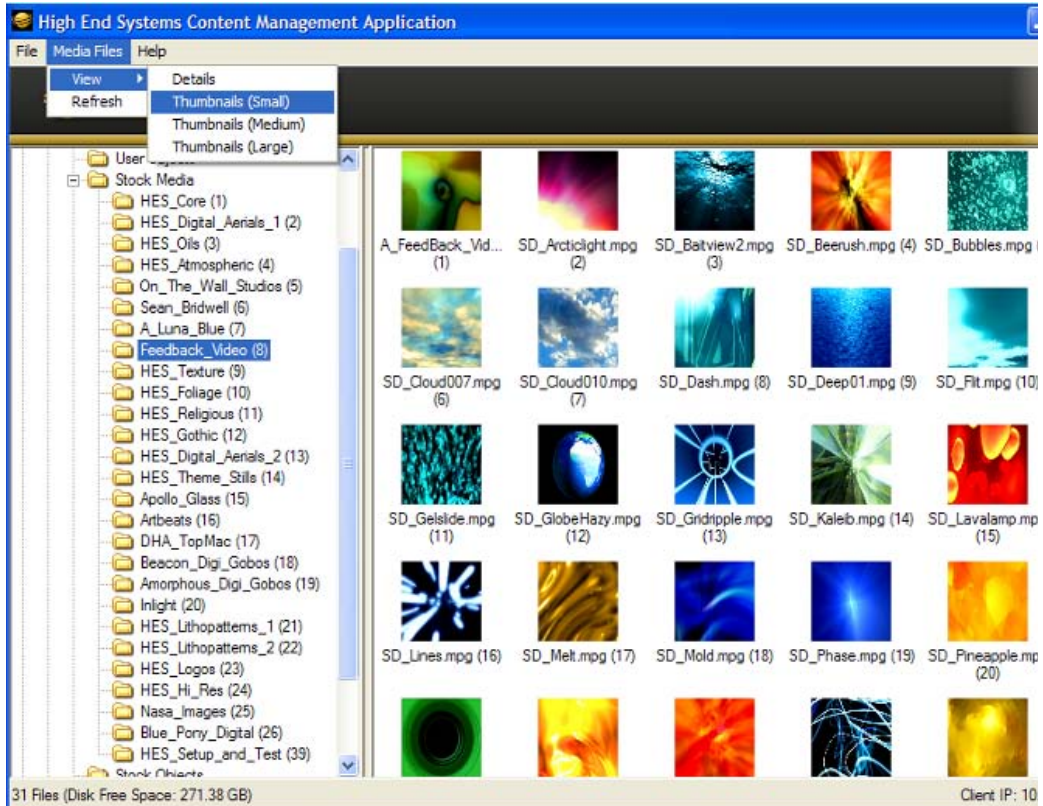

Managing User Content

All Stock and User content can be viewed and refreshed but you have additional control over other aspects of your custom content. Within the CMA Client Window, you can:

- Rename user files and folders
- Delete files and folders
- Control DMX value assignment to files and folders
- Move files and folders between your local drive and a media server.

Naming and Deleting User Content Files and Folders

You can **Rename** any user content folder or file displayed in the right pane of the CMA window using the pull down **Media Folders** or **Objects** menu or with a right click selection. Use the standard Windows operating system naming conventions.

You can **Delete** any user content folder or file displayed in the right pane of the CMA window using the pull down **Media Folders** or **Objects** menu or with a right click selection.

NOTE: *You cannot Delete a movie if the media server is playing it.*

Assigning DMX Values to User Content

The DMX Value associated with each file and folder makes it easy to use the DMX control protocol to identify a unique media file or object.

There are up to 240 Media file folders with each capable of containing up to 255 image or movie media files. This gives a theoretical total of 61,200 possible locations for Media image or movie files. There is one DMX parameter used to identify a object so 255 DMX values are available between the Stock and User Content to identify objects.

Assigning DMX Values Automatically

The CMA can automatically assign a unique DMX value to any file or folder that does not already have a value. This automated assignment is based on alphabetically sorting the existing file/folder names, and assigning each item a unique consecutive integer.

To automatically assign DMX values to a single file or folder with user content:

1. Display the User content folder or file in the right pane of the CMA Window
2. Select **AutoSet DMX** from either the **Media Files** folder or **Objects** drop down menu or the right click popup list. The CMA will assign a valid DMX value to the file or the folder.

You can automatically assign DMX values to all folders at once or to all the files within a folder at once. You cannot set both files and folder values at the same time. To automatically assign DMX values to all the User content folders or all files within a User content folder:

1. Display the User content folders or the files for a single folder in the right pane of the Content Management window and deselect all files or folders.
2. Select **Autoset All DMX** from either the **Media Folders** or **Objects** drop down menu or the right click popup list. The CMA will assign a valid DMX value to all selected files or folders.

Using the same steps, you can also **Reset DMX** for a single file or folder or **Reset All DMX** for all display files or folders displayed in the right pane to zero.

Editing User Content DMX Values

You can manually assign any valid DMX value to your files or folders by selecting the file or folder in the right pane and then, using the pull down menu or the right click popup, selecting **Edit DMX**. A dialog box will allow you to input the DMX value. If it is a valid value from 0-255, the CMA will change the DMX value displayed for the file or folder.

Valid DMX Values

Certain DMX values are **Reserved** for special purposes and are not user assignable. You can change the assigned DMX value for a User Content item to another valid DMX value. A valid DMX value is:

- From 0-255
- Is not one of the reserved values for that type of content
- Is unique from other content of its type except for zero

The following table shows valid and reserved values for User Content.

Content Type	DMX Values	Description	Reserved ?
Media Folders (media file collections)	0	No Selection	No
	1-40	Default Stock media	Yes
	41-239	User collections	No
	240-254	Reserved	Yes
	255	Internal Camera video feed	Yes
Media Files	0	No Selection	No
	1-255	Media files	No
Objects	0	No selection	No
	1-149	Stock Objects	Yes
	150-255	User Objects	No

Moving User Content Files and Folders

User content can be easily moved between fixtures or between your local drive and fixtures.

Which method you use depends on:

- How much content you want to move
- What existing server content you want to preserve
- Whether the client machine is currently connected to the Ethernet fixture link
- If you want to maintain currently assigned content identification DMX values
- Which CMA version you are using (Windows or Mac OS)

There are several methods for moving User content files and media folders between media servers to your local drive:

- Drag and Drop
- Copy and Paste commands
- Cloning transfers the User Content files and their DMX value assignments from one media server to one or more server(s) on the fixture network.
- Creating a Content Archive
- Deploying a Content Archive

Use the following table to determine the best method for your situation.

Fixture Network File-Transfer Method	Transfer Type			Notes
	From Server to Client Machine	From Client Machine to Server(s)	Between Networked Server(s)	
Drag and Drop	Yes	Yes, if format is valid for the destination folder	No	Does NOT preserve DMX Values
Copy and Paste commands	Yes	Yes	No	
Clone	No	No	Yes	Preserves DMX values and Replaces any previous User Content on destination drive
Deploying a Content Archive	No	Yes	No	
Creating a Content Archive	Yes	No	No	Saves assigned DMX values when creating archive from content on a fixture

Downloading Content from a Media Server to Your Local Drive

The CMA supports downloading User content files or folders from a media server to your local drive. To download a file or folder of User Content:

1. Display the Folder or File that you wish to move in the right pane of the CMA window
2. If the destination for the file on your local drive is visible, you can simply drag and drop the folder or file to that location or an external drive connected to your computer.

OR

3. Select **Copy** from the **Media Files** or **Objects** drop down menu or the right click popup list.
4. Browse to the destination on your hard drive; then select **Paste** from the **Media Files** or **Objects** drop down menu or the right click popup list.



Mac OS X: Downloading files

You can drag single or multiple files and folders from a fixture to the Finder.

You can use the copy/paste (Apple-C, Apple-V) to move multiple files from a fixture to the Finder.



Mac OS X: File transfer

SMB limitation is 4GB file size per transfer. What this means is more than 4GB of data may be transferred, but no file can be greater than 4GB in size.

Uploading Content from Your Local Drive to a Media Server

You can upload User Content Media files, Media folders and Object files from your hard drive to a DL.3, DL.2 or Axon media server, provided they are:

- A valid file format (.jpg, .gif, .png, .bmp, .mpg, .m2v for Media Files; .x for Object files)
- You are uploading them to the appropriate User content folder on the media server
- They have been encoded correctly

To upload content:

1. Display the file or folder destination in the right pane of the CMA window
2. Browse to the file or folder you want to upload on your hard drive and click on it to select.
3. Drag and drop it into the appropriate User content folder

OR

4. Select **Copy** from the **Edit** drop down menu or the right click popup list.
5. Select **Paste** from the **Media Files** or **Objects** drop down menu or the right click popup list.

As files are uploaded to fixtures, the User interface displays progress information and notifies the user of any naming conflicts in renamed files or encoding problems.

Content Scanning

Incorrectly encoded content can cause issues with playback performance, network synchronization, and graphics engine stability. To prevent this, the CMA automatically scans content locally on your computer (or the Axon media server) before actually loading it. If no warnings or errors are found, the content is loaded on to the server. If warnings or errors are found, a dialog box describes specific content problems.

Warnings are problems that will potentially cause issues with playback of the media on the fixture, but won't affect graphics engine stability. An example would be a movie not being encoded with all I-frames or not having an End-of-Sequence header. The CMA will allow these files to be loaded on to the server, but it will alert you to potential issues by displaying the warnings in a dialog.

Errors are more serious problems with content that can create severe stability issues in media server software; for example, content encoded as the wrong type of stream (Transport Stream instead of an Elementary Stream). Errors are caused when content does not adhere to the MPEG2 encoding standard. When an error is found, the CMA will not allow this content to be loaded on to a server at all. A dialog will describe the issue, and after dismissing the dialog, you will find the specific file has not been loaded onto the server.

CMA Interaction

When you drag a content file (or folder) on to a server, a dialog shows the progress of the file copy process. If there is nothing wrong with the content, it copies to the fixture.

If warnings or errors are found, the CMA compiles the list of issues in the bottom half of the *Copy Files Progress* dialog.

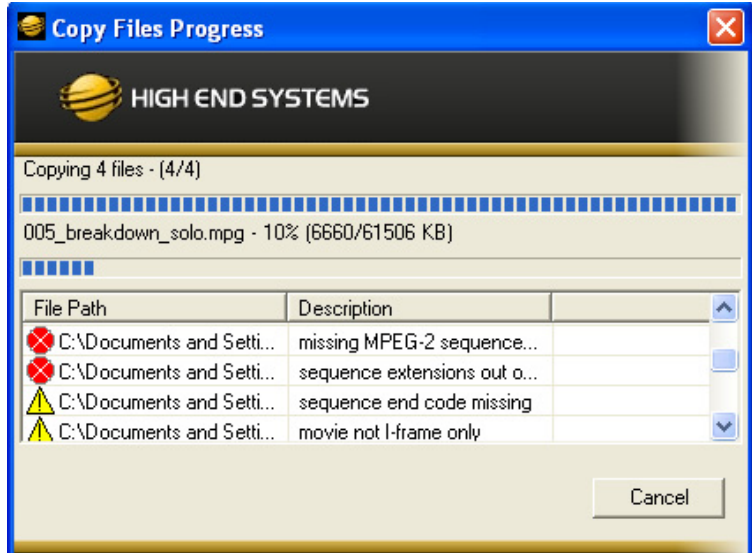

NOTE: *Since the CMA executes the scanning/copying process for the entire group of folders/files in a single operation, it will not stop or pause during the process to dismiss the errors.*

After the process has finished, the dialog will indicate the number of issues that it found and a listing of the affected files. After viewing the list, click on the **Dismiss** button to continue working with CMA.

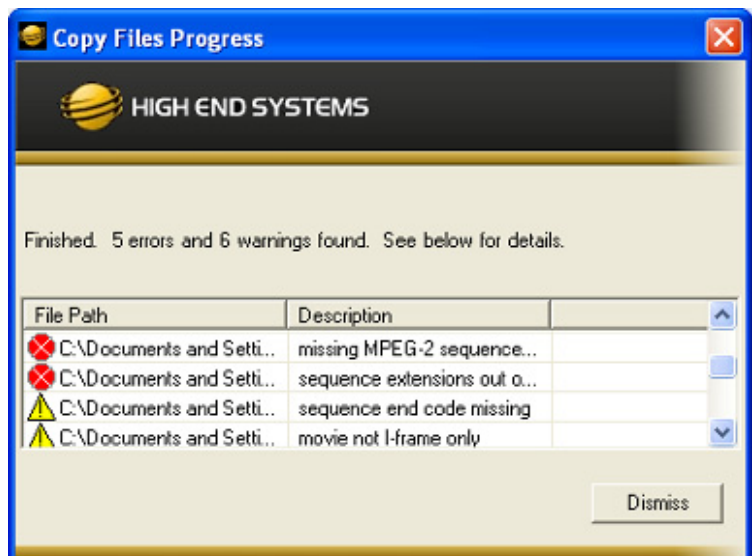

The files with errors in a group of files will not be copied on to the server. Files with warnings will be copied. They will show up highlighted in yellow when viewed in the “Details” view in the CMA to indicate to the user that this file is problematic.

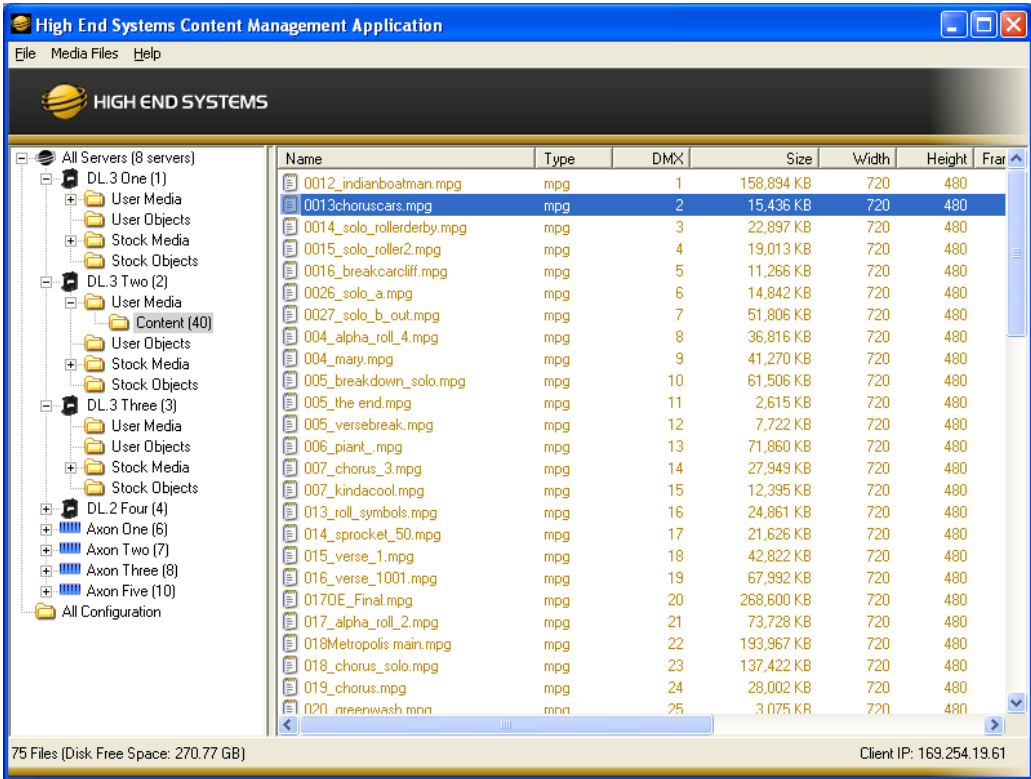

Double-clicking on the highlighted file will bring up another dialog describing the identified file error.

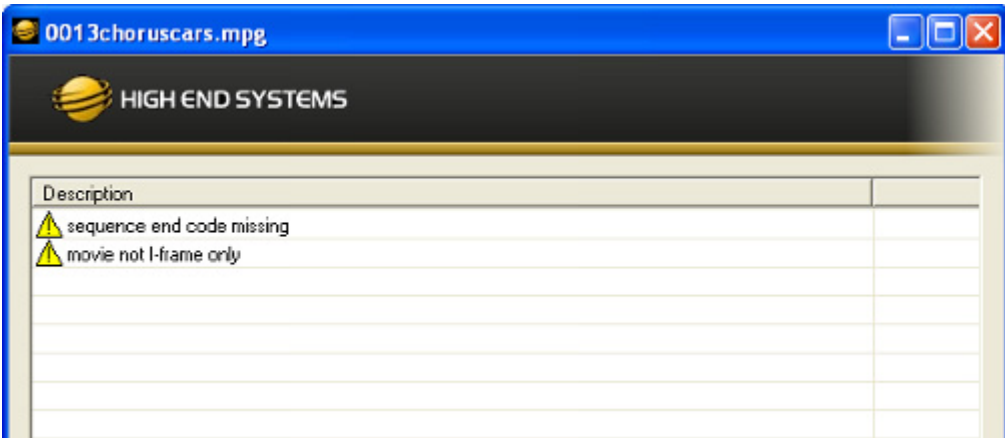

Content Loaded Prior to Version I.5

Any content that was loaded prior to 1.5.0 will be scanned on the first boot of the server. Any files with warnings will be highlighted in yellow, and files with errors will be highlighted in red and automatically have their DMX address reset. This is done to ensure you are aware that content on the fixture is problematic and needs to be corrected.

Warnings

Warning Message	Description/Cause
Unknown start codes detected	User defined start codes encountered. Not all features of the bitstream may be available for playback. May effect playback performance.
Sequence end code missing	All MPEG video streams must end with a sequence end code. The absence of the sequence end code will not prevent playback, but could impact looping and seeking performance.
MPEG-1 movie detected	Bitstream is an MPEG-1 stream. The video should playback, but looping and seeking performance may be affected.
Audio stream detected	Audio data detected in the bitstream. The video should playback, but performance may be affected.
Program stream detected	Content must be encoded in Elementary streams. Program and Transport streams are not accepted. <ul style="list-style-type: none"> The stream should playback, but looping and seeking performance will be affected. The stream may have a delay when started. Inframe and outframe functionality may be impaired.
Movie not I-frame only	The stream should play, but looping, seeking, inframe and outframe functionality may be affected.

Errors

Error Message	Description/Cause
Failed to find movie file	Can't play it if we can't find it.
Transport stream detected	Content must be encoded in Elementary streams. Program and Transport streams are not accepted.
No pictures between sequence headers detected	These errors are caused by: <ul style="list-style-type: none"> data elements in the stream not being in the specified order, data elements being present when they should not be data elements not being present when they should be.
Group start code not followed by I-frame	
Forbidden frame coding detected	
DC intra-coded frames detected	
Reserved frame coding detected	
Missing MPEG-2 sequence extension header	

Error Message	Description/Cause
Sequence extensions out of place	<p>These errors are caused by:</p> <ul style="list-style-type: none">• data elements in the stream not being in the specified order,• data elements being present when they should not be• data elements not being present when they should be.
Sequence display extensions out of place	
Quantization matrix extension out of place	
Copyright extension out of place	
Sequence scalable extension out of place	
Reserved 1 extension out of place	
Picture display extension out of place	
Picture coding extension out of place	
Picture spatial scalable extension out of place	
Picture temporal scalable extension out of place	
Camera parameters extension out of place	
ITU-T extension out of place	
Reserved 2 extension out of place	
Reserved 3 extension out of place	
Reserved 4 extension out of place	

NOTE: A newly uploaded file or folder will have a default DMX value of zero. If a naming conflict occurs, you will be prompted before overwriting the file.



Mac OS X: File transfer

SMB limitation is 4GB file size per transfer. What this means is more than 4GB of data may be transferred, but no file can be greater than 4GB.

Archiving User Content

An Archive/Image is a compressed file used to store media files, folders and object files along with valid identification DMX values. This Content Archive is used to backup User Content that can be restored to any media server.

Using Local Archives to Prepare Content Offline

You can create a Local Archive of files stored on your hard drive to be deployed to a server at another time. This lets you work on organizing files for a specific show offline and then upload it to a server at a later date.

Creating a Local Archive

For CMA Running Windows OS

1. Under the **File** menu, select **Create Local Archive** to launch the archiving wizard.
2. Click on **Add Media Folder**. This will add a media folder to the left-hand column named "MyMedia0". Each successive media folder will be named "MyMedia1, MyMedia2, and so forth. You can rename these folders with a single click on the folder name.

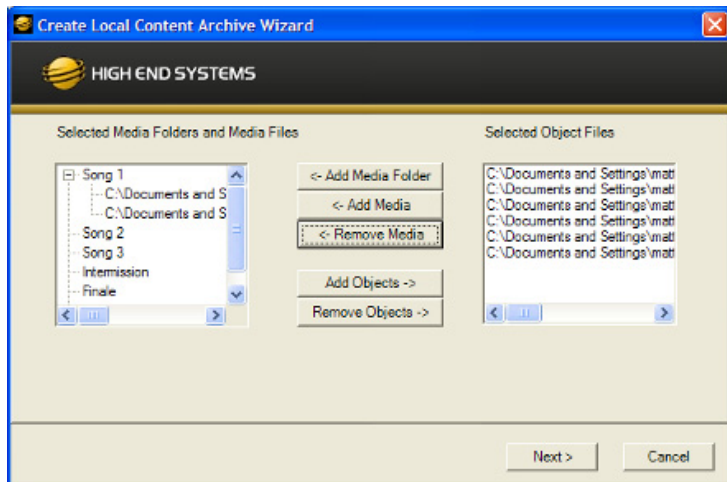

3. After creating a folder and renaming it (if you wish), highlight the folder to add media files.
4. Click **Add Media**. This will bring up a file browser window that will allow you to navigate to the spot on your hard drive containing the media you want to add. You can add single files or multiple files. To add multiple files, hold down shift and select multiple media files with your mouse.
5. Click **Add Objects** if you wish to add custom 3-D objects to the archive. This will again bring up a file browser window to navigate to your 3-D objects. Any 3-D objects added will appear in the right hand column of the wizard. 3-D objects do not get added to folders.
6. Click **Next** at the bottom of the wizard. This will take you to another screen where you choose where to save and what to name your archive.
7. Click **Browse** to navigate to where you want to save and name your archive.
8. Click **Next**. Your archive will then be created.

NOTES: *The Remove Media and Remove Object buttons can be used to remove media files and objects from the wizard when creating the archive.*

Currently, the archive will not be created unless each media folder created has at least one media file in it.

All media folders, files and objects will be assigned DMX addresses in alphabetical fashion.

For CMA Running Mac OS

To create a Local Archive, you must first create the folder structure recognized by the CMA. The Creative Local Archive compresses these files into a .dlc format that can be recognized for uploading. Use the following folder structure in preparing files for a local Archive:

- A top level folder, which contains a Media and Objects folder.
- The Media folder must contain subfolders, and valid files may go into those subfolders.
- Only objects with a .x extension are allowed in the Objects folder (no subfolders).

Creating Content Backup Archive

Backups are created using the **Content Archive** feature. An Content Archive file is a compressed file containing all the User Content from a single fixture along with the assigned DMX values for folders and files.

To create a Content Archive:

1. In the CMA Client Window select **All Server** in the left pane.
2. Select the Server with the content you want to backup in the right pane.
3. Select **Create Content Archive** from the **Media Files** or **Objects** drop down menu or the right click popup list.

Deploying a Content Archive

Deploying the Content Archive you created restores the user content to a fixture. To replicate this content to other fixtures on the link, use the **Clone Content** feature (see *Cloning User Content* on page 267).

Cloning User Content

Cloning is a file transfer operation where all the User Content of a single fixture is replicated across one or more other fixtures. Cloning preserves all user content naming and DMX values. This allows you, for example, to send the custom content for a specific show to all the fixtures used in that show with one operation.

To clone user content:

1. In the CMA Client Window select **All Server** in the left pane.
2. Select the Server with the content you want to clone in the right pane.
3. Select **Clone Content** from the **Media Files** or **Objects** drop down menu or the right click popup list. A Clone Content Wizard lets you select one or more servers on the fixture network as the destination for cloned content.

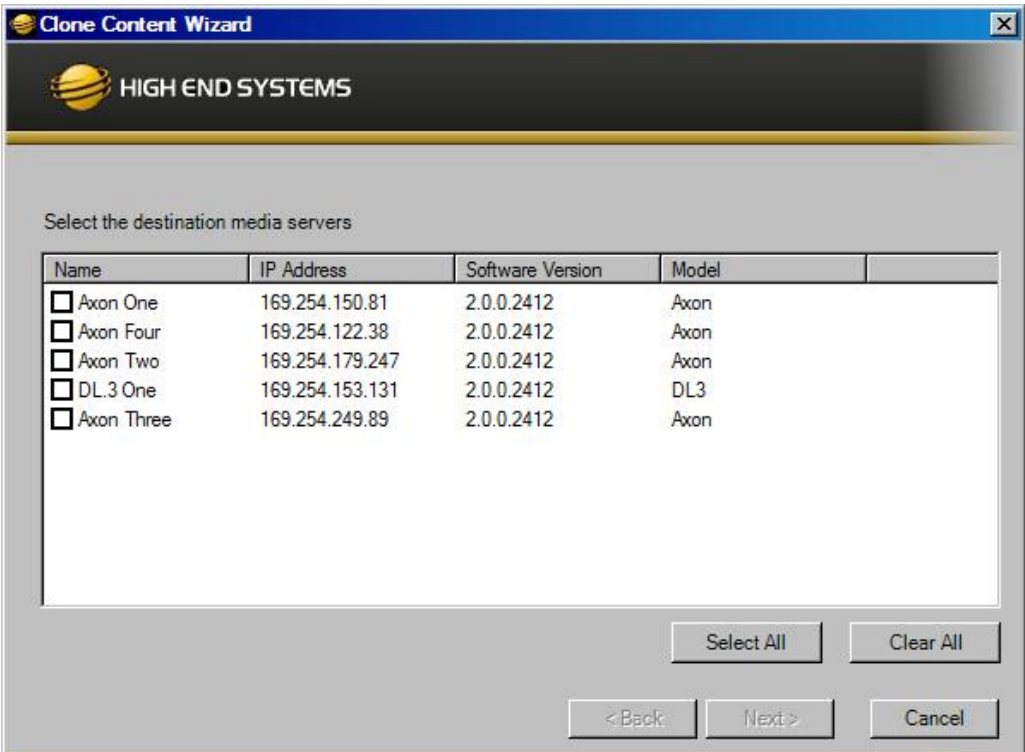

The cloning process erases all destination server(s) user content and replaces it with the selected server's user content. Stock content is unaffected.

Deleting Content

To delete **all** User Content from a server:

1. In the CMA Client Window select **All Server** in the left pane.
2. Select the Server with the content you want to delete in the right pane.
3. From the drop down menu or the right-click popup list, select **Delete Content**. A dialog box OKs/cancels the action.

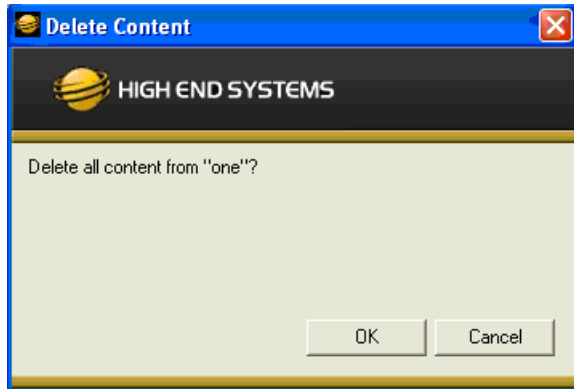

DMX Summary

The DMX Summary lets you view all the content for a single server in a table format with the following details:

- Whether the content is a **User** Media file/folder, a **Stock** Media file/folder, or a **Object**
- The associated **Folder Name** for media files
- The **Folder DMX** value for media files
- The **File Name** for media or object files
- The **File DMX** value for media or object files

To view the DMX summary table:

1. Select **All Servers** from the left pane of the CMA Client Window.
2. Select a Server in the right pane
3. Select DMX Summary from the drop down menu or the right-click popup list.

4. Press the **Create Table** button on the screen to build the summary table.

Press the button to display a table of DMX values for all the content on this media server. If there is a lot of content, this could take a while.

Create Table

User/Stock	Media/Object	Folder Name	Folder DMX	File Name	File DMX
User	Media	batman	40	IDK_TRL2_1080p ReEnc m2v	1
User	Media	Digital Backgrounds	44	023.ANT112_SD_CR.m2v	1
User	Media	Digital Backgrounds	44	023.ATT112_SD_CR.m2v	2
User	Media	Digital Backgrounds	44	023.ATX112H1_SD_CR.m2v	3
User	Media	Digital Backgrounds	44	023.ATX127H2_SD_CR.m2v	4
User	Media	Digital Backgrounds	44	023.CJ112H_SD_CR.m2v	5
User	Media	Digital Backgrounds	44	023.DR127H_SD_CR.m2v	6
User	Media	Digital Backgrounds	44	023.GAS112H1_SD_CR.m2v	7
User	Media	Digital Backgrounds	44	023.GAS125H2_SD_CR.m2v	8
User	Media	Digital Backgrounds	44	025.ANT113_SD_CR.m2v	9
User	Media	Digital Backgrounds	44	025.ATT113_SD_CR.m2v	10
User	Media	Digital Backgrounds	44	025.ATX113H1_SD_CR.m2v	11
User	Media	Digital Backgrounds	44	025.ATX128H2_SD_CR.m2v	12
User	Media	Digital Backgrounds	44	025.CJ113H_SD_CR.m2v	13
User	Media	Digital Backgrounds	44	025.GAS113H1_SD_CR.m2v	14
User	Media	Digital Backgrounds	44	027.ANT114_SD_CR.m2v	15

Upgrading Software

Upgrade Management lets you upgrade the media server application and system firmware.

Verifying Software Versions

Running the latest version of both the CMA software and the media server software will ensure that you get the best performance from the fixtures on your network.

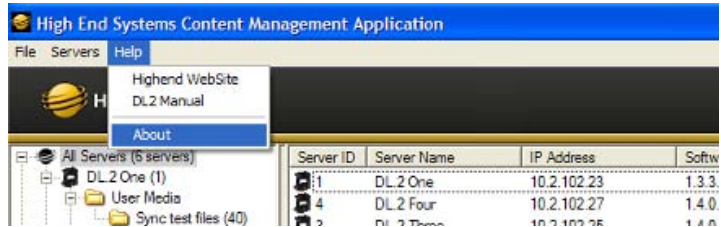

To verify the CMA version, select **About** from the **Help** drop down menu. The media server software version is displayed for each server on the network in the All Servers view.

NOTE: *Although running different versions of software on servers is not prohibited, it is highly recommended that all servers on the network be running the same software version.*

Upgrading the CMA Software

Close the CMA before upgrading the CMA software. To Upgrade software:

1. Download the latest version of the application from the Support section of the High End Systems website (www.highend.com). A download wizard simplifies installation on your personal computer.
2. A dialog box will give you the option to Run or Save the application. Pressing **Run** automatically uninstalls any existing CMA version on your hard drive and installs the new version.

Upgrading Server Software

The server software for Digital Lights and Axon media servers can only be uploaded to fixtures from the CMA. You must first save the latest version of the software from the High End Systems website (www.highend.com) to your hard drive and then use the CMA to upload it to any media server on your link. To Upgrade Server Software:

1. Using your internet browser, select the latest version from the support section of the High End Systems website. A dialog box will give you the option to **Save**.
2. Select the location and press **Save** again to put a copy of the Fixture software on your local drive.

- Click on **All Servers** in the left pane of the CMA Window.

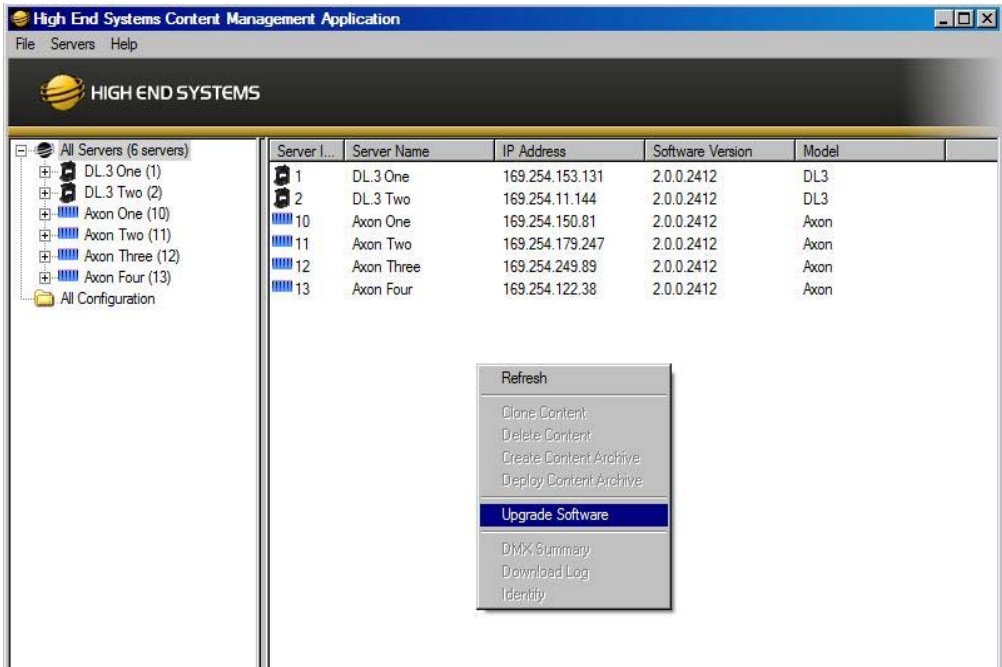

- Right click anywhere in the CMA Window or use the Server's pull down menu to select **Upgrade Software**. The Upgrade Wizard will prompt you to browse to the location where you saved a copy of latest version.

- After locating the upgrade file, press Next. The Upgrade Wizard displays a list of all servers connected to the fixture network.

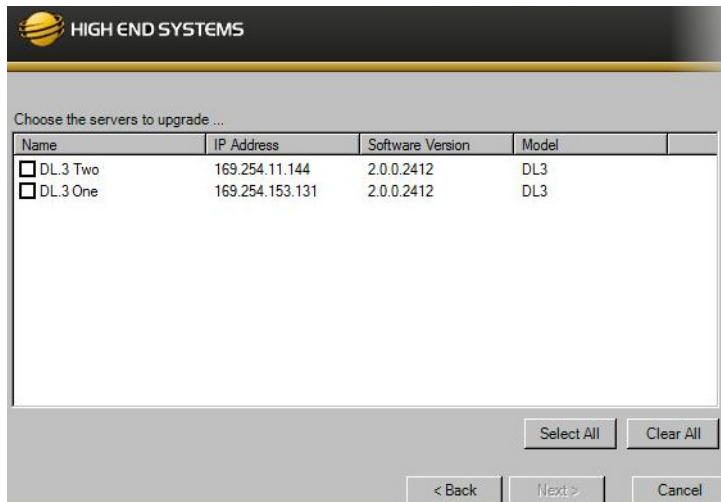

- Click in the box to the left of the server name to select a server(s) for upgrading.
- Click **Next** to continue upgrade. The server will reboot after upgrading the software.



Mac OS X: Upgrading Software

To upgrade multiple servers, select multiple fixtures from the All Servers list.

Viewing Server Configuration

The CMA lets you remotely view and modify fixture settings. Some settings like Lamp Hours, Software Versions, etc. are view only. Other settings such as Fixture ID, various Projector settings, DMX Start Channel, etc. can be modified (configured).

NOTE: *All of these settings are also available for DL.3 and DL.2 fixtures through the Digital Light onboard menu system.*

The CMA also has some additional configuration features that let you:

- Assign a name to servers connected over the network for easier identification of servers on your network.
- Compare all the Configuration Items of a certain type for a group of fixtures. For example, viewing the DMX Start Channels of all the fixtures on a network.
- Control monitor display settings for Axon media servers.

Viewing Current Configuration of All Servers

To view configuration information for all Servers on the network, select All Configurations in the left pane. The right pane now displays configuration values for all the media servers on the fixture link in a sortable table. Click in the column heading to sort by that column's values. A + symbol appears in the "sort by" column heading.

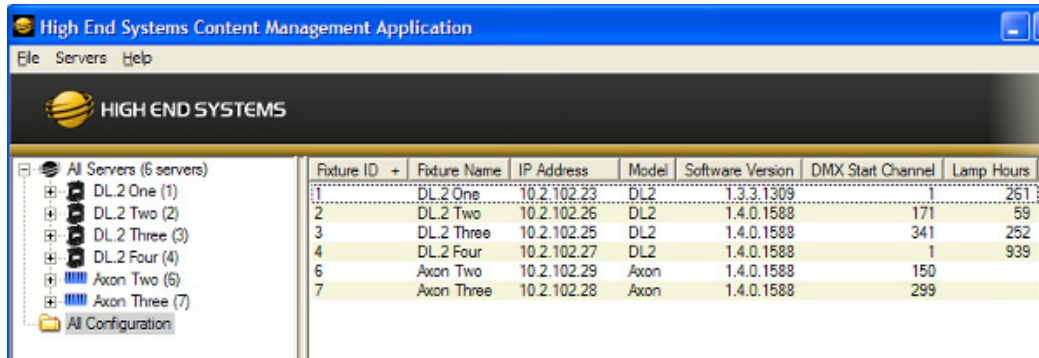

The screenshot shows the High End Systems Content Management Application window. The title bar reads "High End Systems Content Management Application". Below the title bar is a menu bar with "File", "Servers", and "Help". The main area has a "HIGH END SYSTEMS" logo and a tree view on the left. The tree view shows "All Servers (6 servers)" expanded, with sub-items: "DL.2 One (1)", "DL.2 Two (2)", "DL.2 Three (3)", "DL.2 Four (4)", "Axon Two (6)", "Axon Three (7)", and "All Configuration". The "All Configuration" item is selected, and a table is displayed on the right. The table has columns: "Fixture ID", "Fixture Name", "IP Address", "Model", "Software Version", "DMX Start Channel", and "Lamp Hours". The table contains 7 rows of data.

Fixture ID +	Fixture Name	IP Address	Model	Software Version	DMX Start Channel	Lamp Hours
1	DL.2 One	10.2.102.23	DL2	1.3.3.1309	1	261
2	DL.2 Two	10.2.102.26	DL2	1.4.0.1588	171	59
3	DL.2 Three	10.2.102.25	DL2	1.4.0.1588	341	252
4	DL.2 Four	10.2.102.27	DL2	1.4.0.1588	1	939
6	Axon Two	10.2.102.29	Axon	1.4.0.1588	150	
7	Axon Three	10.2.102.28	Axon	1.4.0.1588	299	

The example above contains the following information for one or all servers:

- The Fixture ID from 1-255
- The Fixture Name you have assigned
- The IP Address
- Model type
- The DMX Start Channel currently assigned to each server
- The current lamp hours for each server

File Configuration Help

HIGH END SYSTEMS

Server | Fixture | Lamp | Test/Reset | Hardware | I/O

DL.3 one (1)

User Media

User Objects

Stock Media

Stock Objects

DL.3 two (2)

DL.3 Three (3)

User Media

User Objects

Stock Media

Stock Objects

DL.2 four (4)

DL.3 Five (5)

User Media

User Objects

Stock Media

Stock Objects

Axon one (11)

User Media

User Objects

Stock Media

Stock Objects

Axon two (12)

Axon three (13)

Axon four (14)

All Configuration

DMX Settings

DMX Start Channel: 1

Source: Art-Net

Artnet Subnet: 1

ArtNet Universe: 1

DMX Protocol: v2 | 9

Version Information

Software: 2.0.0.2372

XPe: 2.2.0

Firmware: 1.5.4.156

Server Info

Model: DL3

Fixture ID: 1

Fixture Name: DL.3 one

IP Address: 169.254.153.131

Unique Number: 92902AA1

Disk Free Space: 279,748 MB

Misc

Fixture Defaults: On

Reboot Server

Apply

< Previous Server | Next Server -> | Cancel

File Configuration Help

HIGH END SYSTEMS

Server | Display Settings | Hardware | I/O

DL.3 two (2)

User Media

User Objects

Stock Media

Stock Objects

DL.3 Three (3)

User Media

User Objects

Stock Media

Stock Objects

DL.2 four (4)

User Media

User Objects

Stock Media

Stock Objects

DL.3 Five (5)

User Media

User Objects

Stock Media

Stock Objects

Axon one (11)

User Media

User Objects

Stock Media

Stock Objects

Axon two (12)

Axon four (14)

All Configuration

DMX Settings

DMX Start Channel: 1

Source: Art-Net

Artnet Subnet: 1

ArtNet Universe: 10

DMX Protocol: v2 | 4

Version Information

Software: 2.0.0.2372

XPe: 3.3.0

Firmware: 1.4.0.26

Server Info

Model: Axon

Fixture ID: 11

Fixture Name: Axon one

IP Address: 169.254.150.81

Unique Number: 76261FD4

Disk Free Space: 291,351 MB

Misc

Fixture Defaults: On

Reboot Server

Apply

< Previous Server | Next Server -> | Cancel

Client IP: 169.254.72.242



Mac OS X: Viewing Server Configuration

To access Server Configuration information for an individual server, select the Configuration option under the individual server.

DL.3 and DL.2 Media Server Configuration Options

DL.3 and DL.2 fixtures include configuration options for the internal projector, the lamp, the menu display and motion features. The six tabs are labeled Server, Fixture, Lamp, Test/Reset, Hardware and I/O.

Server Tab

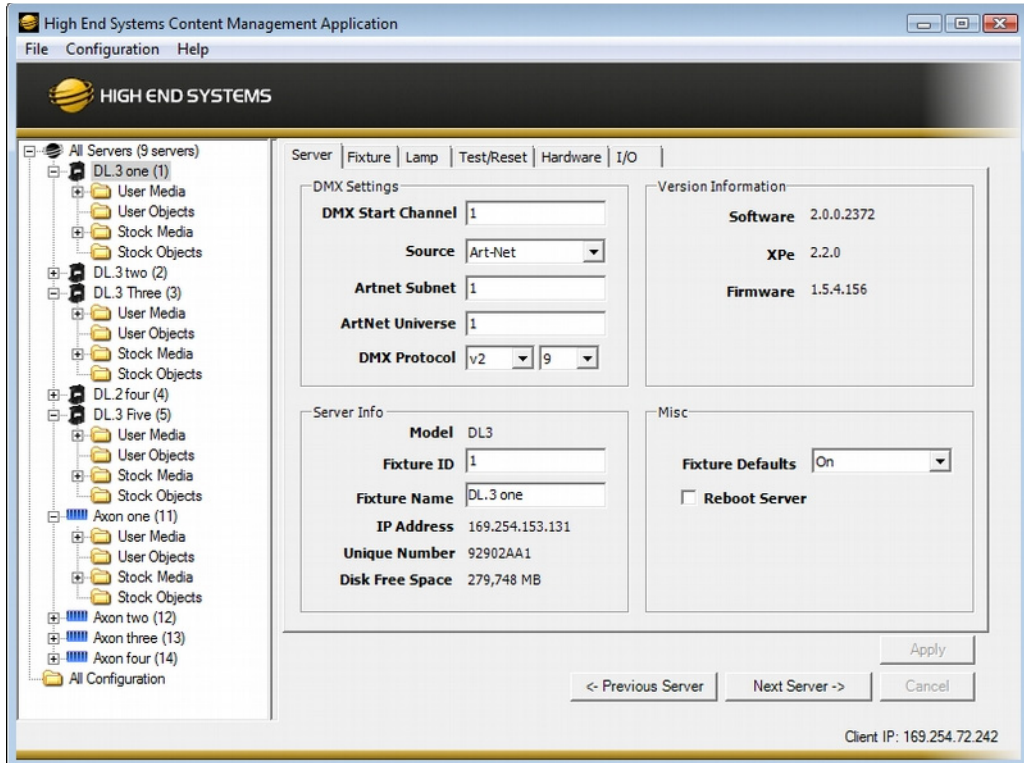

DMX Settings

Configuration Item	Configuration Value Options	
DMX Start Channel	1-512	
DMX Source	DMX512 or Art-Net	
Art-Net Subnet	0-16	
Art-Net Universe	0-16	
DMX Protocol	V1 V2	Sets graphic objects from 1-9

Server Info

Configuration Item	Configuration Value Options
Model	Read only
Fixture ID	1-255
Fixture Name	Allows fixture name of up to 26 characters
IP Address	Read only assigned to that unit by the router or Auto IP
Unique Number	Read only assigned by factory
Disk Free Space	Read only

Version Info

Configuration Item	Configuration Value Options
Software	Read only
XPe	Read only
Firmware	Read only

Miscellaneous

Configuration Item	Configuration Value Options
Fixture Defaults	On restores fixture defaults Off displays whenever defaults has been changed
Reboot Server	Check Reboot to restart the internal graphics engine

Fixture Tab

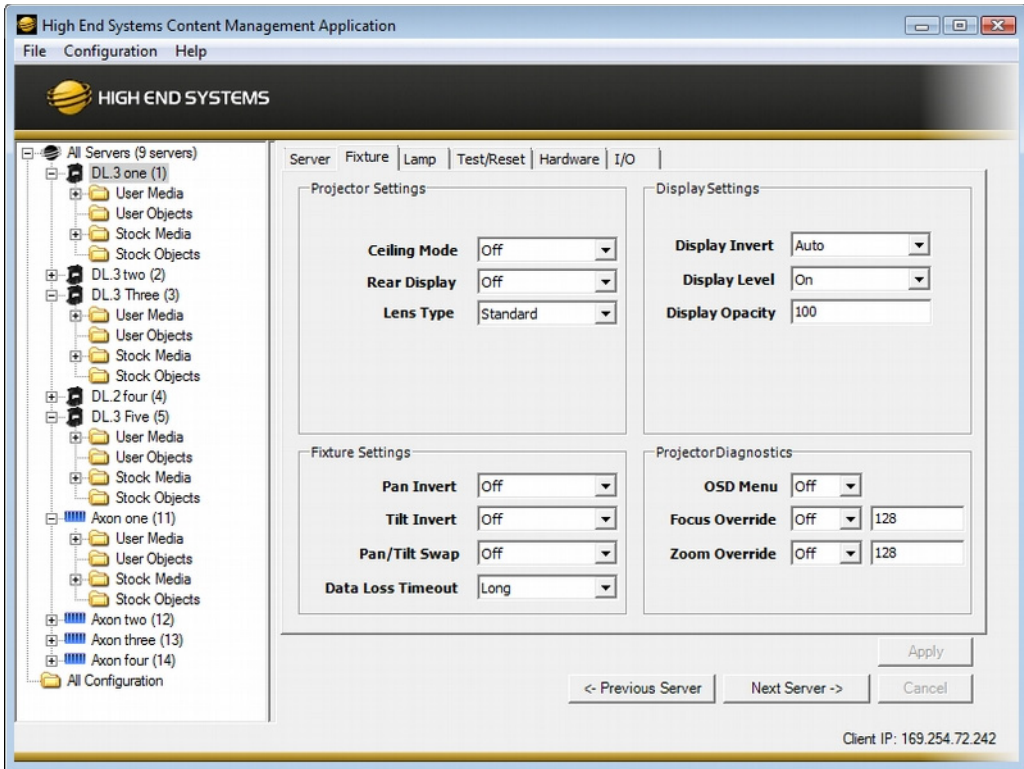

Projector Settings

Configuration Item	Configuration Value Options
Ceiling Mode	On accesses the projector menu to rotate the image 180° Off reverts to original orientation
Rear Display	On accesses projector menu to invert the projected image Off reverts to original orientation
Lens Type	Select currently installed lens from Standard , Long Throw , Ultra Long Throw , or Wide Angle for DL.3 fixtures. <i>NOTE: This option is greyed out for DL.2 fixtures.</i>

Fixture Settings

Configuration Item	Configuration Value Options
Pan Invert	On Inverts pan positioning Off reverts to default position
Tilt Invert	On Inverts Tilt positioning Off reverts to default position
Pan/Tilt Swap	On swaps pan and tilt positioning Off reverts to default positioning

Configuration Item	Configuration Value Options
Data Loss Timeout	Closes iris when system stops receiving DMX data: Long = 5 minute delay Short = 5 second delay

Display Settings

Configuration Item	Configuration Value Options
Display Invert	On manually inverts display, Off reverts to default display orientation, Auto automatically inverts display when fixture is turned more than 90 degrees vertically.
Display Level	Off turns off display. Touching any button turns it back on. Bright = full brightness level Preview = displays currently selected content
Display Opacity	0-100 sets the preview display opacity from 0-100%

Projector Diagnostics

Configuration Item	Configuration Value Options
OSD Menu	On accesses the projector's menu navigation buttons Off reverts to Fixture menu
Focus Override	On selects manual focus. Value field = 0-255
	Off resets to DMX control
Zoom Override	On selects manual zoom. Value field = 0-255
	Off resets to DMX control

Lamp Tab

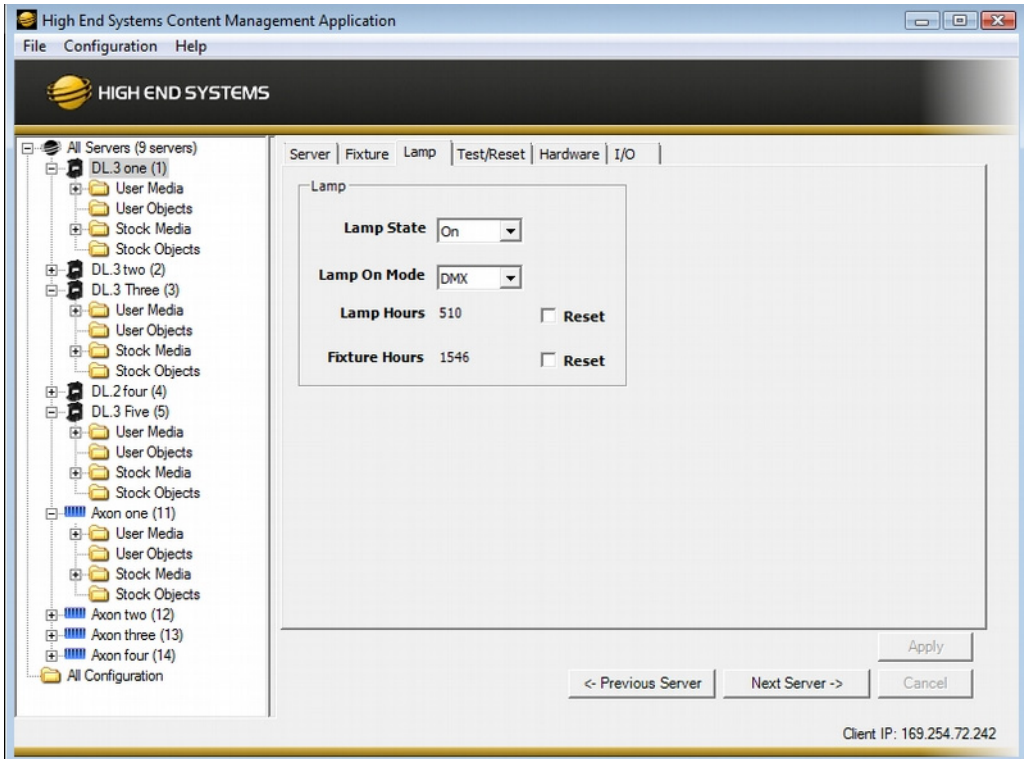

Configuration Item	Configuration Value Options
Lamp State	On manually turns projector lamp on Off manually turns projector lamp off
Lamp On Mode	Always On turns lamp on when the fixture is plugged in Manual turns lamp on only if the Lamp is set to On DMX turns lamp on if DMX is present
Lamp Hours	Read Only. Select Reset to restore Lamp hours to 0
Fixture Hours	Read Only. Select Reset to restore Fixture hours to 0

Test/Reset Tab

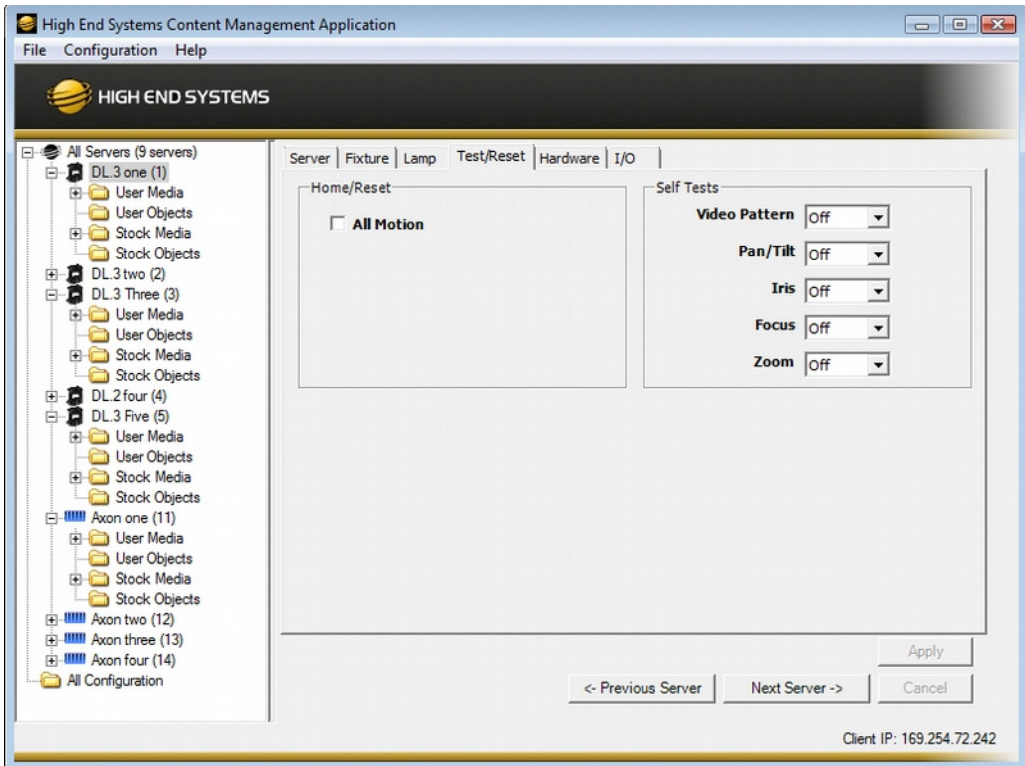

Home/Reset

Configuration Item	Configuration Value Options
All Motion	Select to start automatic mechanical reset for all motion functions.

Self Tests

Configuration Item	Configuration Value Options
Video Pattern	1 displays graphic object with texture for the number of graphic layers you have defined 2 alternates between an alignment grid and a color calibration screen
Pan/Tilt	On tests Pan and Tilt mechanical functionality Off stops self test
Iris	On tests Iris mechanical functionality Off stops self test
Focus	On tests focus mechanical functionality Off stops self test
Zoom	On tests Zoom mechanical functionality Off stops self test

Hardware Tab

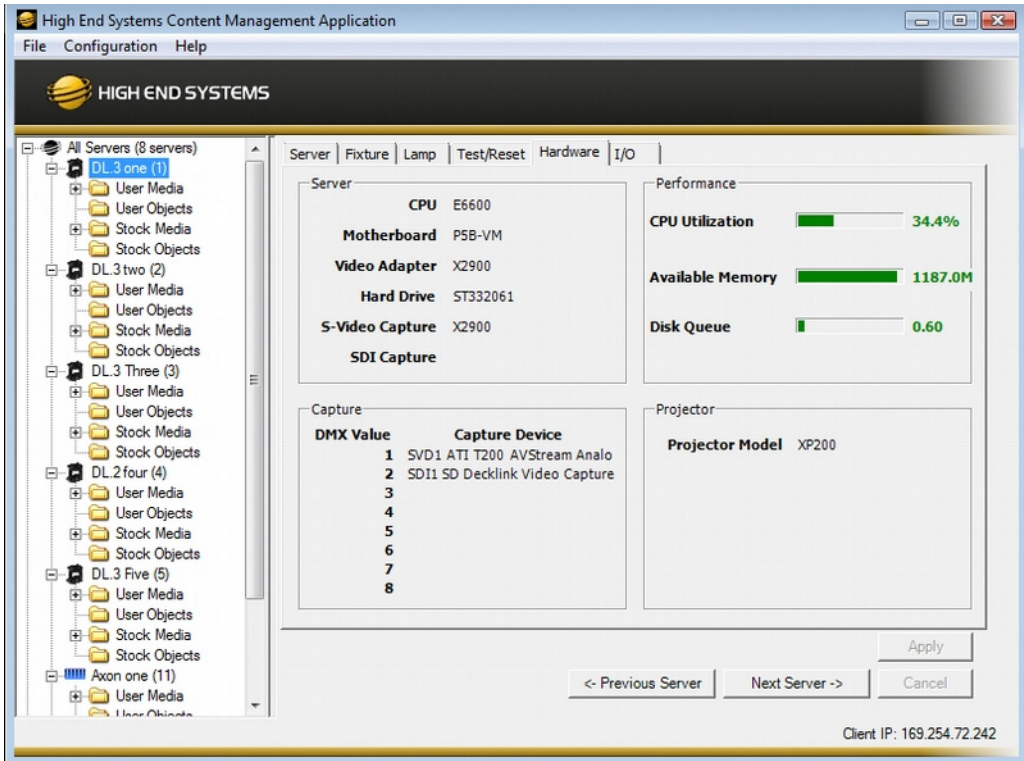

Server

Configuration Item	Configuration Value Options
All CPU	Read Only displays current hardware configuration
Motherboard	
Video Adapter	
Hard Drive	
S-Video Capture	
SDI Capture	

Performance

Configuration Item	Configuration Value Options
CPU Utilization	Gauges display available resources remaining. This can help with balancing additional layers with the capabilities for the hardware configuration of this device.
Available Memory	
Disk Queue	

Capture

Configuration Item	Configuration Value Options
DMX Value and Capture Device	Displays configured capture devices at DMX values 1–8.

Projector

Configuration Item	Configuration Value Options
Projector Model	Read Only

I/O Tab

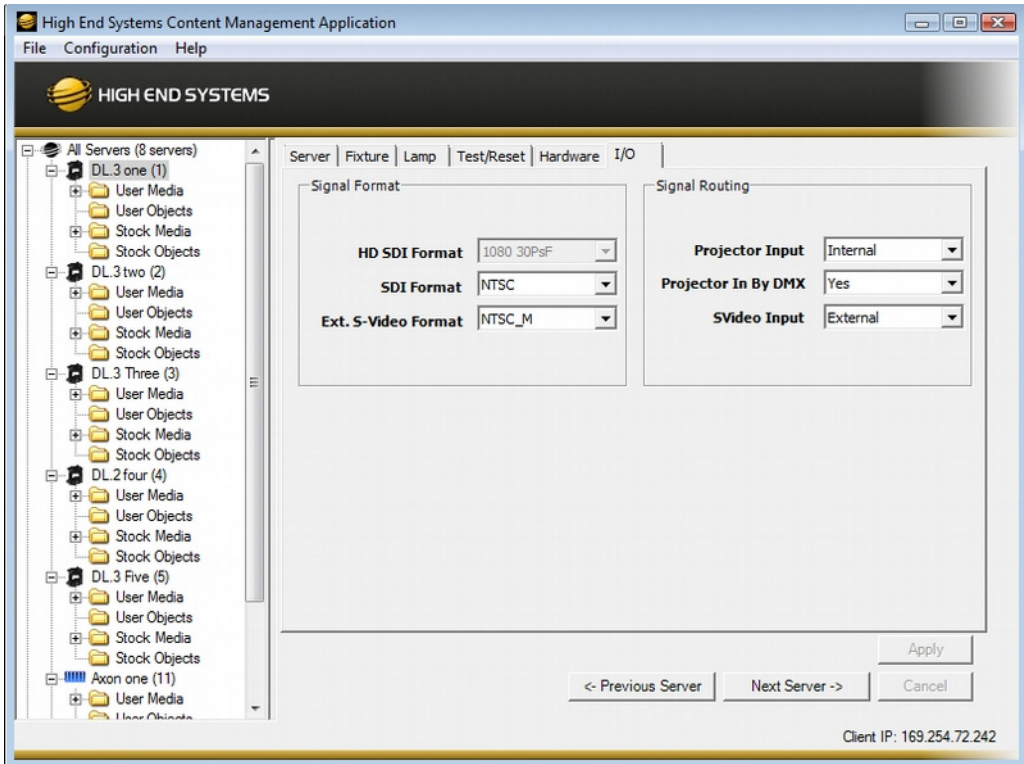

Signal Format

Configuration Item	Configuration Value Options
SDI 1t	
SDI 2 <i>(inactive in DL.3F model)</i>	Format options vary depending on the cards installed in this device.
Ext S-Video Format <i>(inactive in DL.3F model)</i>	NTSC_M NTSC_MJ PAL_B PAL_D PAL_GPAL_H PAL_I PAL_M PAL_N SECAM_B SECAM_D SECAM_G SECAM_H SECAM_K SECAM_K1 SECAM_L SECAM_L1

Signal Routing

Configuration Item	Configuration Value Options
Projector Input	Internal External
Projector In By DMX	Yes No
SVideo Input	Internal External

Axon Media Server Configuration Options

Axon configuration options are grouped under a Server tab and a Display Settings tab.

Server Tab

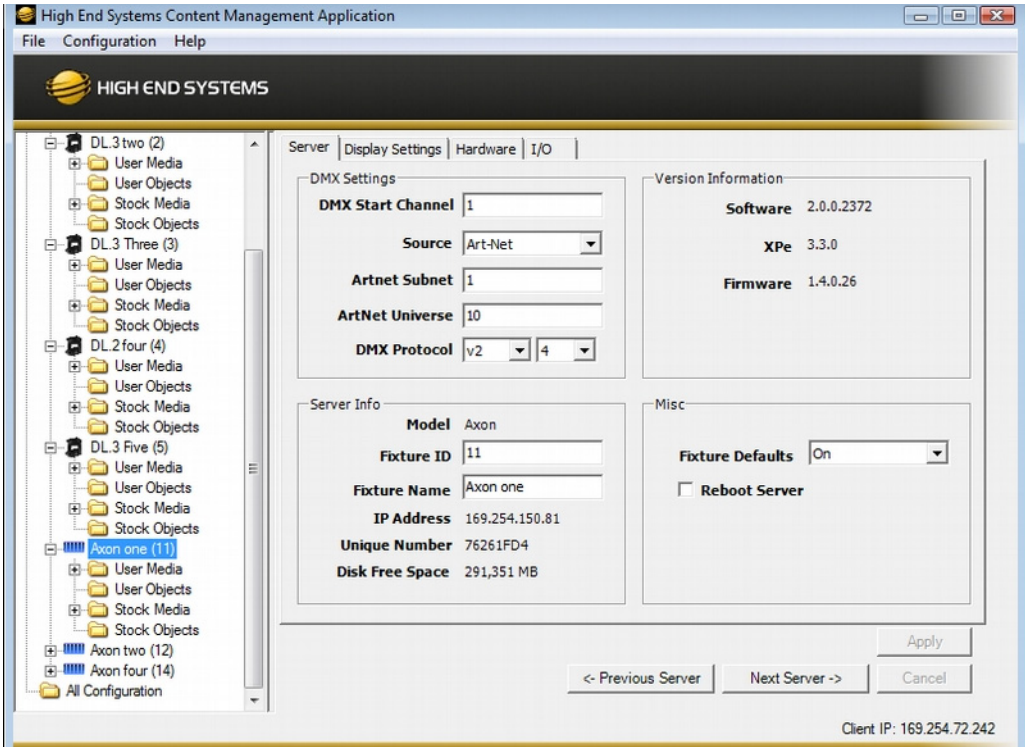

DMX Settings

Configuration Item	Configuration Value Options	
DMX Start Channel	1-512	
DMX Source	DMX512 or Art-Net	
Art-Net Subnet	0-16	
Art-Net Universe	0-16	
DMX Protocol	V1 V2	Sets graphic objects from 1-9

Server Info

Configuration Item	Configuration Value Options
Model	Read only
Fixture ID	1-255
Fixture Name	Allows fixture name of up to 26 characters
IP Address	Read only assigned to that unit by the router or Auto IP

Configuration Item	Configuration Value Options
Unique Number	Read only assigned by factory
Disk Free Space	Read only in MB

Version Info

Configuration Item	Configuration Value Options
Software	Read only
XPe	Read only
Firmware	Read only

Miscellaneous

Configuration Item	Configuration Value Options
Fixture Defaults	On restores fixture defaults Off displays whenever defaults has been changed
Reboot Server	Check Reboot to restart the internal graphics engine

Display Settings Tab

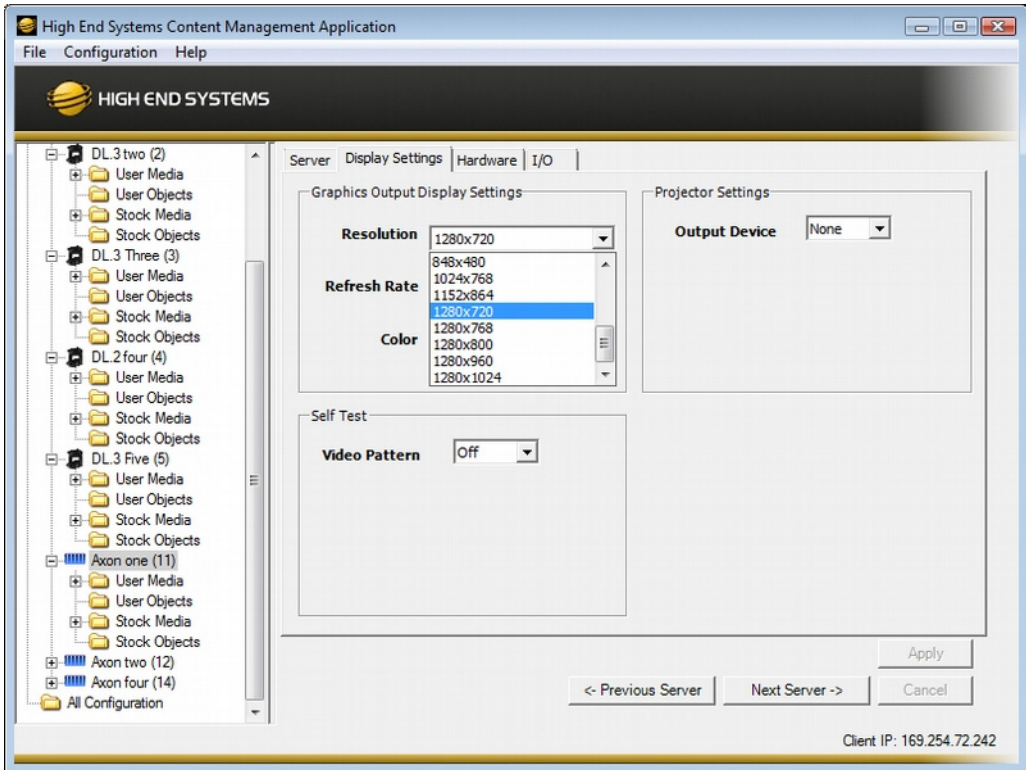

Graphics Output Display Settings

Configuration Item	Configuration Value Options
Resolution	Options in the drop-down lists are automatically populated by the Axon software for the specific display device attached.
Refresh Rates	
Color	

Projector Settings

Configuration Item	Configuration Value Options
Output Device	Read Only displays projector model

Self Tests

Configuration Item	Configuration Value Options
Video Pattern	<p>1 displays graphic object with texture for the number of graphic layers you have defined</p> <p>2 alternates between an alignment grid and a color calibration screen</p>

Hardware Tab

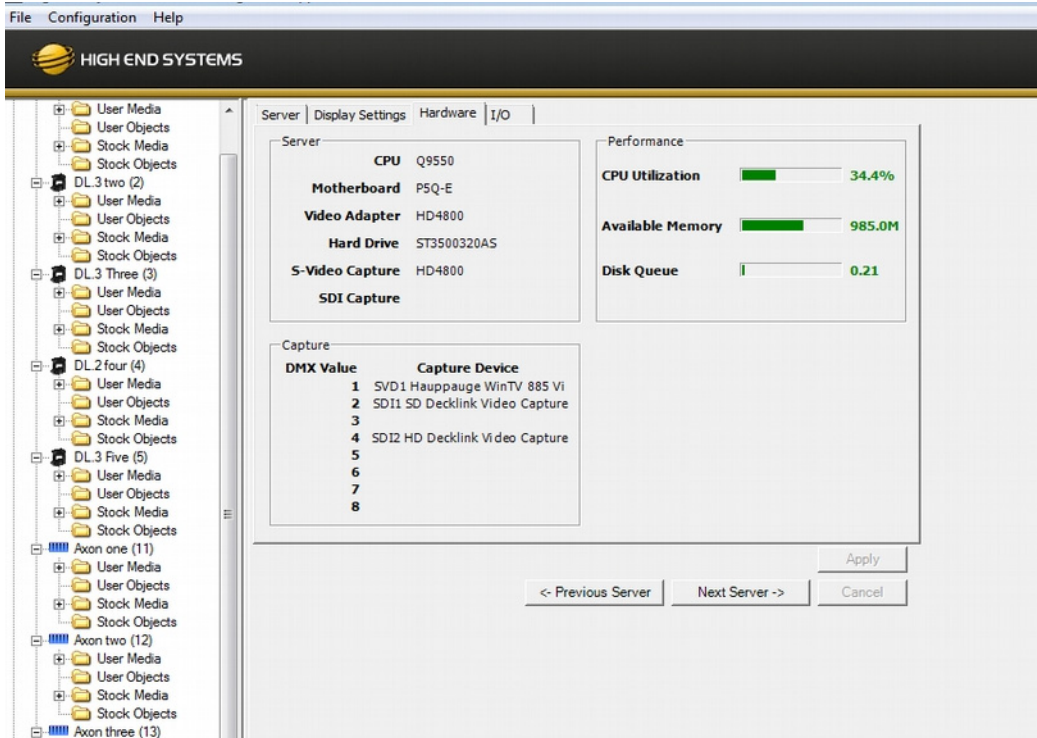

Server

Configuration Item	Configuration Value Options
All CPU	Read Only displays current hardware configuration
Motherboard	
Video Adapter	
Hard Drive	
S-Video Capture	
SDI Capture	

Performance

Configuration Item	Configuration Value Options
CPU Utilization	Gauges display available resources remaining. This can help with balancing additional layers with the capabilities for the hardware configuration of this device.
Available Memory	
Disk Queue	

Capture

Configuration Item	Configuration Value Options
DMX Value and Capture Device	Displays configured capture devices at DMX values 1–8.

I/O Tab

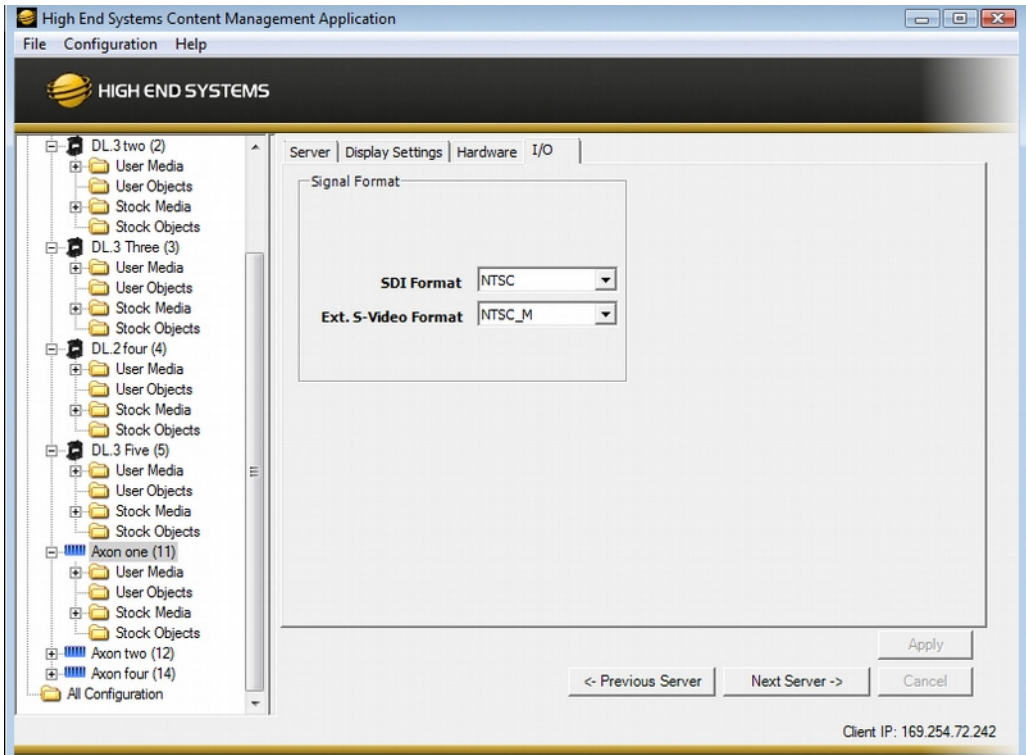

Signal Format

Configuration Item	Configuration Value Options
SDI 1t	Format options vary depending on the cards installed in this device.
SDI 2	
Ext S-Video Format	NTSC_M NTSC_MJ PAL_B PAL_D PAL_GPAL_H PAL_I PAL_M PAL_N SECAM_B SECAM_D SECAM_G SECAM_H SECAM_K SECAM_K1 SECAM_L SECAM_L1

Configuration Example

Before programming a Digital Light fixture or the Axon media server from a DMX512 console, you need to:

- Identify the DMX Source for the fixture
- Select the Protocol type to determine the DMX channel footprint this fixture will utilize
- Select a Fixture Number to identify this Axon on the Ethernet link (required if you will be synchronizing output between fixtures).
- Assign a valid Start Channel (the first channel in the unique range of DMX channels designated by the console for this Axon)

All these selections can be made in the **Server** tab for all models of media servers.

1. To view configuration information for a individual server, click on **All Servers** in the left pane of the CMA window and select the + to view all the servers on the fixture network. Select a server in the left pane to view its configuration information in the right pane.

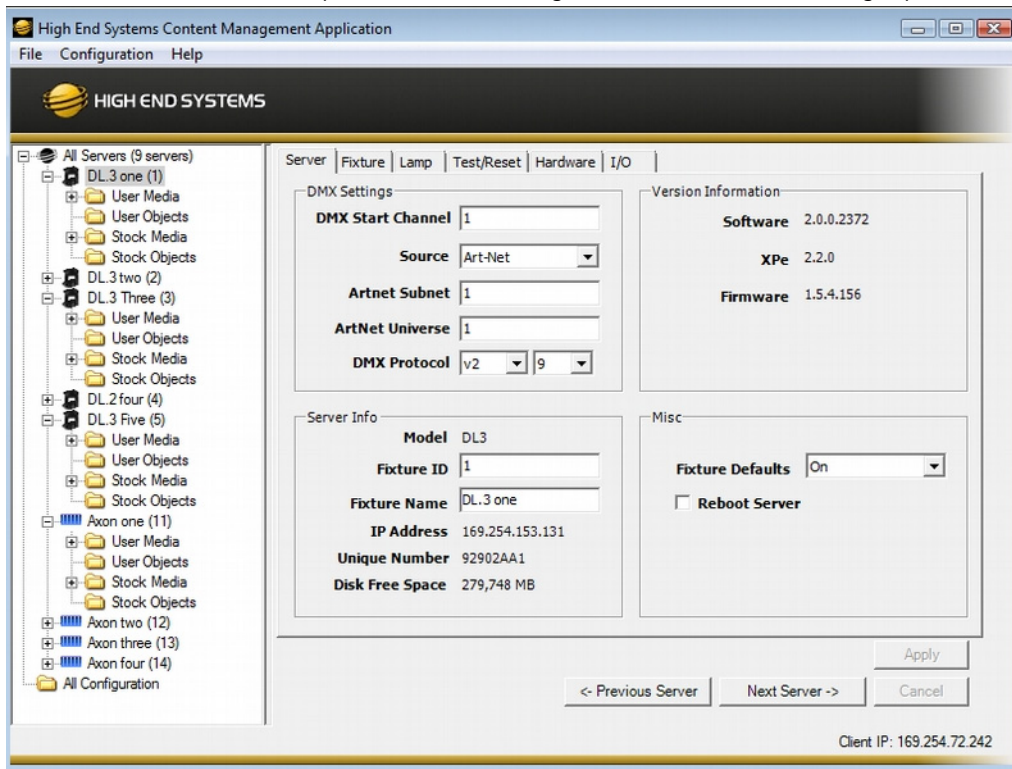

2. Select a **DMX Source** type by clicking on the down arrow of the Source field to select DMX512 or Art-Net.

If you select Art-Net, assign a universe number from 1–16.

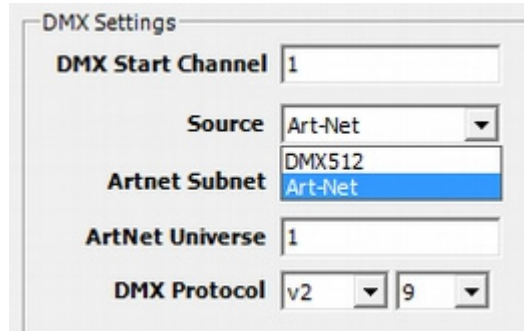

3. Select a **DMX Protocol** type by choosing **V1**, or **V2** from the drop down list in the option field. and then select the number of Graphic Object layers for your application.

The Protocol you select is based on how many DMX channels are required for your application. For more information on selecting protocol, see *Protocol Options* on page 55 and *Appendix A: DMX Protocol* on page 311.

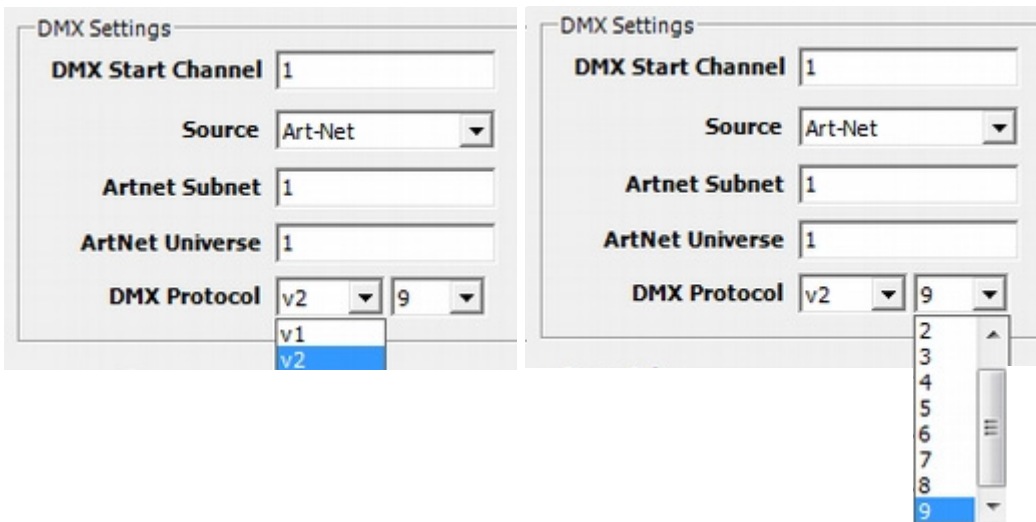

4. Edit the DMX **Start Channel** by entering a valid Start Channel for the protocol type you have chosen.

For more information on selecting a valid start channel, see *Determining a DMX Start Channel* on page 40.

Chapter 17:

Maintenance and Troubleshooting

This chapter includes information on replacing parts, cleaning the fixture, and some basic troubleshooting procedures.

The following toolset should be all you need for the maintenance procedures in this chapter:

- M3 allen wrench
- M4 allen wrench
- #2 Phillips screwdriver
- Gloves
- Protective eyewear
- Mild glass cleaner (containing no ammonia) and a soft, lint-free cotton cloth



WARNING:

This fixture must be serviced by qualified personnel. The information listed in this chapter is intended to assist qualified personnel *only*.

Pan and Tilt Locking

The DL.2 fixture is equipped with mechanical pan and tilt locking latches to stabilize the fixture for shipping or servicing. There is a single pan lock position and three tilt lock positions.

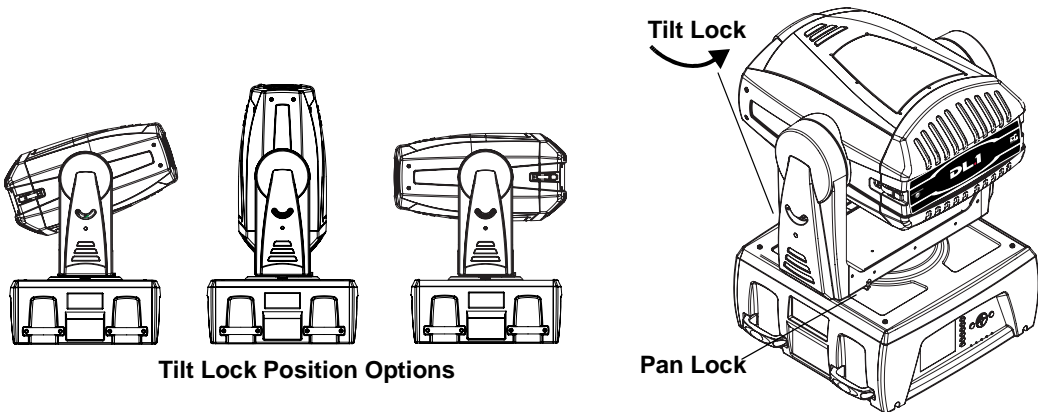

Maintaining the Filtering System

Like all high quality video projection units, the DL.2 fixture must be kept protected from excessive amounts of glycol fog, mineral oil, and smoke. DL.2 fixtures incorporate multiple air filters to reduce these risks to a minimum; however, the user must follow these guidelines to ensure continued operation of the fixture:

- Air filters (both fixture and projector) should be checked and cleaned on a regular basis. When used in a closed or fixed environment where fog or haze is used, we recommend at least a weekly check.
- Do not situate DL.2 in areas of high fog density such as directly in front of a fog machine or mineral oil hazer.
- Minimize the exposure of DL.2 to both glycol fog and mineral oil.

Filter Warnings

The DL.2 menu system displays a series of filter status and warnings to alert you when a filter needs to be cleaned or replaced. These appear in a large format that can be viewed from a distance. The Info_Status menu screen will include a detailed message concerning the large format Error/Warning filter message. The following messages will give you information regarding the status of the DL.2 filter system:

- **Filter Missing Error:** A filter not present or is not installed properly. Check and insert missing filter.
- **Filter Service Warning:** The filter system is not operating optimally and needs to be serviced soon.
- **Filter Service Error:** The filter system needs immediate servicing. Replace Filter.

For these and other Error/Warning messages, see *Status Message Menu Display* on page 301.

Cleaning and Replacing Filters

The DL.2 system utilizes multiple filters to protect the internal media server and projector.

- A filter is located on the side of the fixture base housing attached with velcro for easy removal and cleaning. Check this filter often for dust or debris that can be caused when using the DL.2 in environments with confetti or pyrotechnics. ***This filter is washable, but must be completely dry before re-installing.***
- The Fixture head contains both a hepa filter and a prefilter
- The internal projector has two filters

Check the following warnings and cautions before servicing the filters:



WARNINGS!

Disconnect power before servicing.

Replace fuses with the specified type and rating only.



Equipment surfaces may reach temperatures up to 130° C (266° F). Allow the fixture to cool before handling.



CAUTION!

Do not operate a projector with Air Filter removed. Dust may accumulate on LCD Panel and Projection Mirror degrading projection quality.

Do not put small parts into Air Intake Vents. It may result in malfunction of a projector.

Cleaning the Base Housing Filter

This filter is located between the handles on the fan side of the box. You can pull it off the fixture and clean it with soap and water. Allow it to dry thoroughly before replacing.

Replacing the Fixture Filter

A hepa filter and a prefilter are located inside the fixture head and should be replaced whenever they become discolored from particulates or when the Menu displays **FILTER Service ERROR** or **FILTER Service WARN**

Access the fixture filters

1. Lock the fixture head in the 70° tilt position.
2. Unlatch and remove the rear bezel assembly.
3. Loosen the two quarter-turn screws on the top cover and remove the top cover.
4. Slide the top cover back to free it from the front bezel.

Inspect the filters:

5. Lift the prefilter away from the filter bracket
6. Remove the two philips pan screws securing the filter bracket and lift the filter unit off the fixture.
7. Remove the bracket and lift the HEPA filter out of the filter housing. Inspect both the prefilter and the HEPA filter.

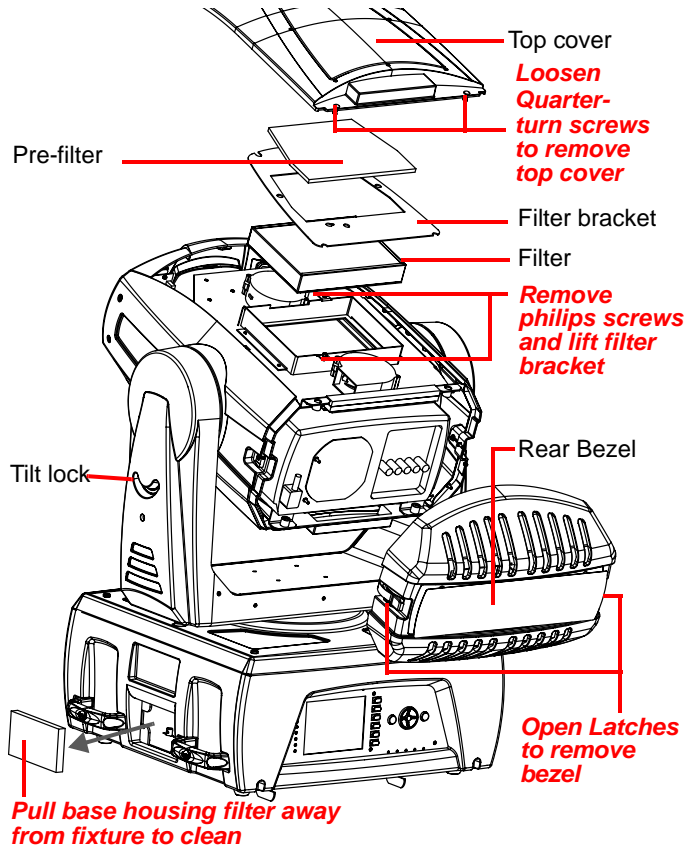

8. A dirty prefilter can cause an early Service Filter warning. If the prefilter looks dirty, clean it with water. Thoroughly dry the prefilter before proceeding.
9. If the HEPA filter is discolored with particulates, replace it with the part listed in *Related Products and Optional Accessories* on page 4.

Reassemble the Fixture

10. Reinstall the HEPA Filter with the rubber gasket down.
11. Reattach the filter bracket with the two philips pan screws.
12. Replace the prefilter over the bracket on velcro tabs.
13. Replace the top cover, fastening it with the two quarter-turn screws.
14. Carefully replace the rear bezel, making sure to position (but *do not force*) the gasket against the lamp cover located on the back of the projector.

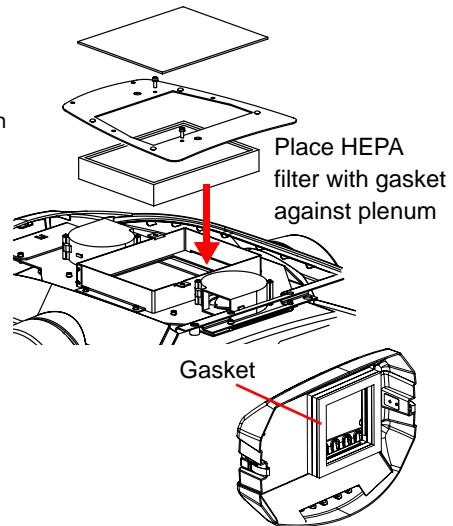

Cleaning the Internal Projector Filter

Internal projector air filters prevent dust from accumulating on surface of Projection Lens and Projection Mirror. If the projector Air Filter becomes clogged with dust particles, it will reduce the cooling fans' effectiveness and may result in an internal heat build up that can shorten projector life.

Clean the projector air filter using the following steps:

1. Disconnect the fixture from power.
2. Rotate and lock the fixture head in the or 90° tilt position.
3. Unlatch and remove the rear bezel.
4. Loosen two quarter-turn screws to remove the bottom cover and locate the *filter removal tool* mounted on the chassis.
5. Loosen the 2 phillips head screws to remove the tool and use it to grasp and lift the two air filters from the internal projector.
6. Clean air filter with compresses air, a brush or wash out dust and particles with mild soap and water.
7. If the filter damaged, replace it only with the part listed in *Related Products and Optional Accessories* on page 4.

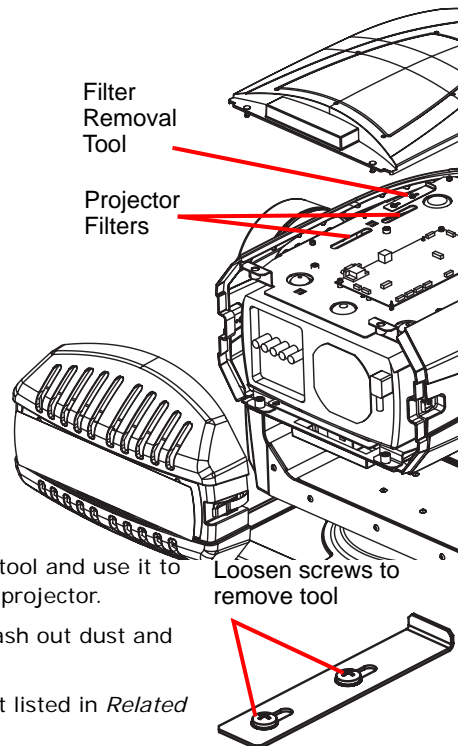

8. Replace **completely dry** filters in slot. The filters are keyed for positioning. Make sure that both filters are fully inserted.

Replacing the Lamp



WARNING!

Equipment surfaces may reach temperatures up to 130° C (266° F). Do not attempt to hot-restrike the lamp.

Allow the projector to cool for at least 45 minutes before you open the lamp cover. The inside of the projector can become very hot.

For continued safety, replace with a lamp assembly of the same type.

Do not drop the lamp module or touch the glass bulb! The glass can shatter and cause injury.

1. Shut down the fixture and disconnect from power.
2. Allow the projector to cool for at least 45 minutes.
3. Unlatch and remove the back bezel.
4. Loosen the two phillips head screws and open the lamp cover.
5. Loosen the two phillips head screws, grasping the handle and pull out the lamp assembly.
6. Replace the lamp assembly, see *Related Products and Optional Accessories* on page 4.
7. Seat the assembly and tighten the two lamp assembly screws.
8. Close the lamp cover and tighten the two lap cover screws.
9. Reconnect to power.

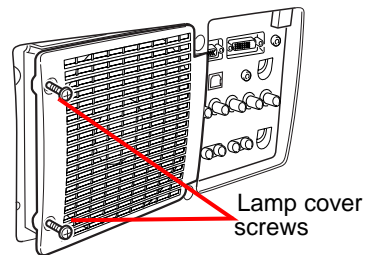

Lamp Assembly

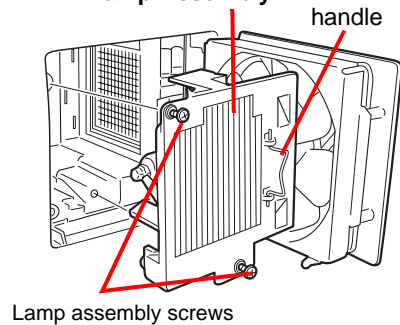

Replacing the Fuse



WARNINGS!

Disconnect power before servicing.

Replace fuses with the specified type and rating only.



Equipment surfaces may reach temperatures up to 130° C (266° F). Allow the fixture to cool before handling.

The DL.2 has one user-serviceable fuse which controls mains voltage to the fixture.

To replace a fuse:

1. Disconnect power to the fixture. If the fixture has been operating, allow the fixture to cool before handling.
2. Loosen the 2 Phillips head screws on the top cover of the connector side of the box.
3. Tilt the connector panel away from the box.
4. Remove the fuse from the fuse holder.
5. Replace the fuse with a 5A, slow-blow fuse *only*.
6. Replace the side and top panels.

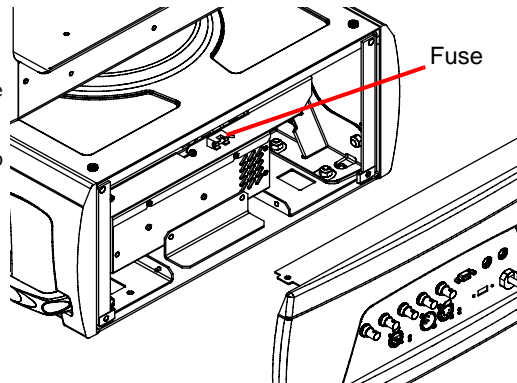

Cleaning or Replacing the Front Window



WARNINGS!

Disconnect power before servicing.



Equipment surfaces may reach temperatures up to 130° C (266° F). Allow the fixture to cool before handling.

To access the front window:

1. Remove the four phillips head screws (two on each side of the front bezel)
2. Slide the bezel from the front of the fixture.

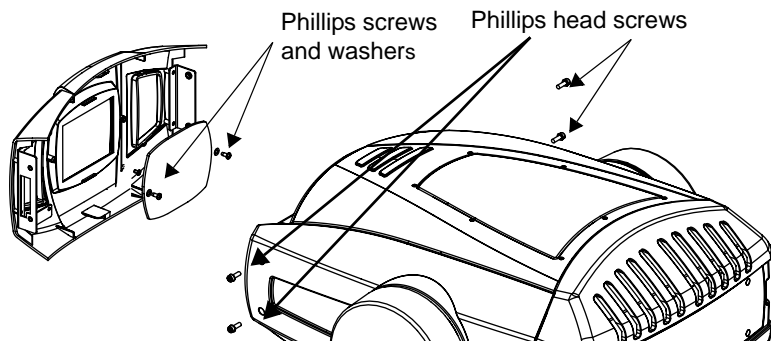

3. Disconnect power to infrared illuminator.
4. Inside the bezel, locate the two Phillips head screws and washers securing the front window in place.
5. Remove the screws, making sure not to misplace the washers.
6. Clean the front window using a mild glass cleaner (containing no ammonia) and a soft, lint-free cotton cloth.
7. If the window needs replacement, use the part specified in *Related Products and Optional Accessories* on page 4.
8. Carefully replace the Phillips screws and washers, making sure not to break the glass.



CAUTION!

Use plastic washers only when replacing the front glass. Using metal washers can damage the glass.

9. Reconnect power to the infrared illuminator
10. Replace the front bezel.

Replacing Motor Driver Boards



WARNINGS!

Disconnect power before servicing.

Replace fuses with the specified type and rating only.



Equipment surfaces may reach temperatures up to 130° C (266° F). Allow the fixture to cool before handling.

The DL.2 fixture is designed with two motor driver boards:

1. The board that controls the motors for the tilt, focus, zoom, and iris functions as well as fans is located in the fixture head.
2. The board that drives pan motor and fans is located in the base housing.

All cabling is marked with labels corresponding to locations on board for easy replacement. When changing a board, align the screw holes and standoffs to ensure correct orientation in the fixture.



CAUTION!

The fixture will not function correctly if contact screws are missing from driver boards.

Fixture Head Driver Board

To replace the fixture head driver board:

1. Disconnect power to the fixture and allow it to cool.
2. Unlatch the two rear latches and remove the rear bezel.
3. Use a 3 mm allen wrench to remove the addressing screws and star washers.
4. Position new board against module aligning the center top standoff. Place contact screw(s) in the appropriate position.

Note: *When installing a replacement driver board on a module, always place a star washer between an address screw and the pad on the logic board to ensure good electrical contact.*

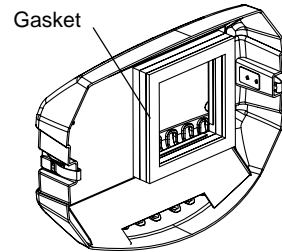

5. Carefully replace the rear bezel, making sure to place (but *do not force*) the gasket over the lamp cover located on the back of the projector.
6. Ensure that the fixture is on a solid surface. Select **Calibrate Motors** through the Test_Home menu screen and leave the fixture undisturbed for 10 minutes while calibration occurs.

Replacing Fixture Base Driver Board

To replace motor driver board located in the fixture base housing:

1. Disconnect power to the fixture. If the fixture has been operating, allow the fixture to cool before handling.
2. Loosen the two phillips head screws on menu display panel side of the Box cover
3. Loosen screws on menu display panel and gently open away from the fixture leaving the harness cabling attached.
4. The driver board for pan functions and fans is located directly behind the display.
5. After detaching all cabling, pull board out and replace.



CAUTION!

The fixture will not function correctly if contact screws are missing from driver boards.

6. Reattach cables.
7. Replace the side panel and top cover. Make sure you align the assembly properly when inserting; damage to the fixture can result from improper alignment.
8. Ensure that the fixture is on a solid surface. Select **Calibrate Motors** through the Test_Home menu screen and leave the fixture undisturbed for 10 minutes while calibration occurs.

Troubleshooting

This section discusses troubleshooting LED states and general troubleshooting suggestions.

Button Shortcut Commands

DL.2 fixtures have button commands available for controlling and overriding functionality when you are troubleshooting your fixture.

- Holding the [Menu] & [Enter] buttons for more than two seconds disables motion system. Motors are still energized so unit can be pointed for trouble shooting. To Exit this mode, press the [Menu] & [Enter] buttons again for two seconds, or send a Global Reset command.
- Holding down the middle two menu Tab Select buttons for more than two seconds initiates a Global Reset of the motion hardware and homes the unit.
- Holding down the second from the top and second from the bottom Tab Select buttons for more than two seconds opens the iris when the fixture software is not running to allow navigation for content upgrades and motion uploads. To Exit this mode, press the same button combination again for more than two seconds.

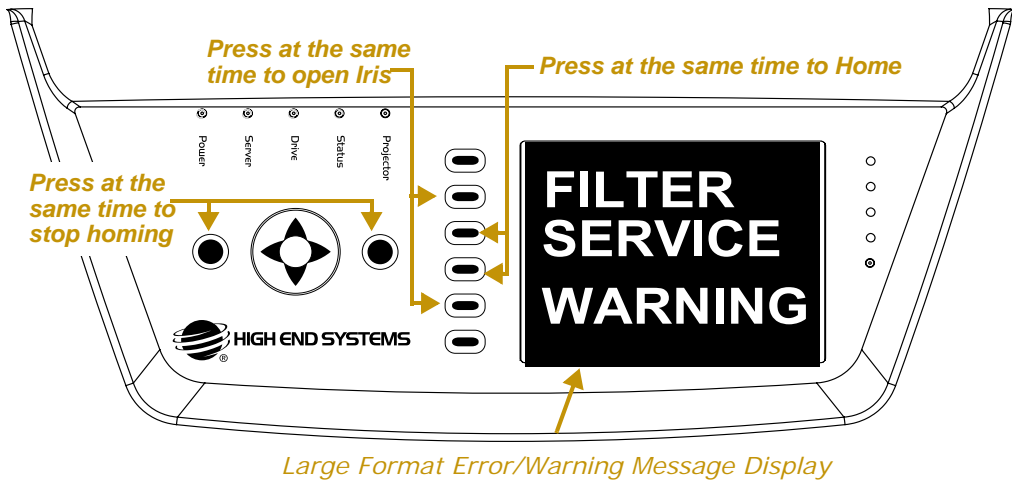

Status Message Menu Display

The DL.2 fixture menu displays error/warning information in two ways. The first is the large block format that can be viewed from a distance when the menu is idle. When there is more than one message, the large format display cycles through the messages. Each message displays for 3 seconds before cycling to the next message and continues looping through these messages until they have been cleared internally or you interact with the menu.

Button Action

When in the large format display, pressing any button reverts to the normal menu display, showing the Detailed Message Display pane in the Info_Status tab of the menu. At that point, you can view the detailed information for the error/warning messages or navigate elsewhere.

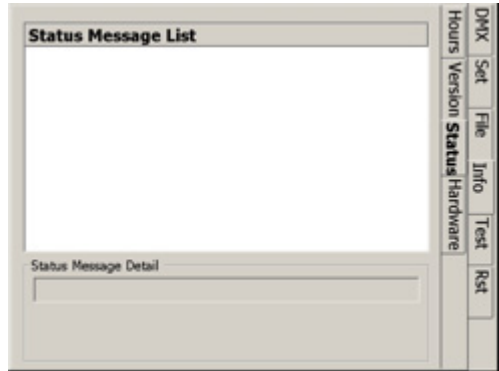

Inactivity Timer

After 30 seconds of inactivity from the display navigation/editing buttons has passed, the display returns to the large format error display should there be any new messages to be displayed or if there is a persistent error. A persistent error is a case where the error condition continues to occur.

The second way to view Status messages is by navigating to the Info_Status screen. This screen displays current error or status messages. If there are multiple error/warning messages displayed, use the up/down arrows to scroll through the list in the top pane. When an item is highlighted in the top pane, the bottom pane details information associated with that error.

Supported Error/Warning Messages

Issue	Large Format Message	Message Detail	Notes
Projector Temperature Status	Info_Status tab only This message does not appear in large format	PROJ STATUS-COOLING The projector must cool down before it can re-strike the lamp	This message will end when the fixture has reached the recommended operational temperature
Motion Shut Down Status		Motion Shut Down The Motion Systems is in shut down mode. To return to normal operation, power cycle or perform a HOME ALL	Home the fixture through the menu system "Test_Home_Motion All_Home" screen, or the CMA, (see page 281) or from the DMX console (see page 238).
Camera Communication Error	CAMERA COMM ERROR	The system is unable to communicate with the Camera.	Check the Ribbon cable connections at the camera and the head card. (the Blue side should be facing out). Use the camera's zoom buttons to check that the camera has power.

Issue	Large Format Message	Message Detail	Notes
Filter Missing Error	FILTER MISSING ERROR	Filter not present. Insert Filter!	See <i>Cleaning and Replacing Filters</i> on page 294
Service Filter Error	FILTER SERVICE ERROR	Filter needs Servicing. Replace Filter NOW.	
Filter Service Warning	FILTER SERVICE WARN	Filter needs Servicing. Replace Filter SOON.	See <i>Cleaning and Replacing Filters</i> on page 294
Projector Lamp Life Error	LAMP LIFE ERROR	The Lamp has exceeded it's rated life and must be replaced now.	See <i>Replacing the Lamp</i> on page 297.
Projector Lamp Life Warning	LAMP LIFE WARN	The Lamp is nearing the end of it's rated life. Replace soon	
Projector Communication Error	PROJ COMM ERROR	The system is unable to communicate to the Projector.	Check the Comm cable connections at serial port on the back of projector and at the fixture head card. Make sure lamp is struck
Projector Temperature Fail Error	PROJ TEMP ERROR	Projector temperature has exceeded operational range and has shutdown	Cool fixture and then restrike the lamp
Projector Temperature Warning	PROJ TEMP WARN	Projector is over recommended operating temperature	
USB port Communication Error	USB INIT ERROR	The PC failed to initialize USB communication with the box card.	Contact High End Systems Customer Support
USB port Security Error	USB SECURE ERROR	USB failed to pass the hardware security test.	

System State LEDs

Five labeled LEDs on the display panel indicate the following system activity:

Name	Color	State	Description
Projector	White	On	Projector lamp is on
		Off	Projector lamp is off
		Blinking	Projector lamp is either cooling down or in a indeterminate state
Status	Green	On	(45 sec On/1.4 sec.Off) Running normal motion-control code
		Blinking	Board communication activity; for example, during a software upload
		Blinking Slowly	320 processor card in the base housing is receiving code.
Drive	Amber	Blinking	Hard drive activity
Server	Blue	Steady	Internal computer is receiving power
Power	Red	Steady	Fixture's Motion Control system is receiving power

Board LED States

LEDs located on DL.2 fixture boards indicate how the unit is functioning. The following Table lists LED States, and problems they may indicate.

Location	LED #	State	Problem ?	Description
Fixture Head Card	LD1	Steady Orange	No	S3 (iris) sensor open
		Red, Green or OFF	Yes	Link communication error
	LD2	Slow Flashing Green	No	Running system code, normal operation
		Fast Flashing Green	Maybe	Running boot code, expecting or updating firmware
		Red, Green or OFF	Yes	No firmware or power
Base Housing Card	LD1	Flashing Green	No	Normal operation
		Flashing Red	Maybe	Updating firmware
	LD2	Off	Maybe	No DMX send or received
		Green	No	Receiving DMX
		Red	Maybe	Transmitting DMX
	LD3	Steady Orange	No	Normal Operation
Red, Green or OFF		Yes	Link Communication error	

General Troubleshooting Suggestions

The following table shows general troubleshooting suggestions:

Problem	Solution
Won't power on	<ul style="list-style-type: none"> • Check the fuse (<i>page 298</i>). • Verify fixture is plugged in to an appropriately-rated power source (power ratings are shown on <i>page 350</i>). • Check power cord wiring (<i>page page 350</i>).
During certain movements the fixture motion slows, missteps or loses position	<ul style="list-style-type: none"> • If you have loosened or tightened anything in the pan and tilt assemblies, the stepper motors may be out of alignment. Recalibrate pan and tilt motors by selecting Calibrate Motors button in the Test_Home menu screen.
Powers on but no image	<ul style="list-style-type: none"> • Is the mechanical iris closed? If so, check the setting for the Dimmer parameter, (see <i>Dimmer</i> on page 237.) • Did you recently change inputs? About 10 seconds are required for an input change to take effect. However, you might have selected an invalid input using projector controls. Try setting the projector back its defaults, (see <i>Reset Screen</i> on page 38. Or use DMX to exit the projector menu system (see <i>Projector Control</i> on page 239). • Make sure a video input is physically attached to the input you selected, and that the video feed is active.

Problem	Solution
Image is blurry, out of focus, or colors are unnatural	<ul style="list-style-type: none"> • Check the Fixture filters (see <i>page 295</i>). • Is the DL.2 mounted less than 1.4 meters to an object? If so, move the DL.2 farther away to enable it to focus properly. • Make sure the DL.2 is not operating near fog machines, hazers, or mineral oil hazers (see <i>Fog Machine Warning</i> on page 8). • Clean the front window (see <i>Cleaning or Replacing the Front Window</i> on page 298). • Check the lamp (see the projector manual shipped with the DL.2). • If you're using the projector's on-screen programming system, you can override zoom and focus using the menu system (see <i>Projector Control</i> on page 239.)
The LCD Menu display is off	<ul style="list-style-type: none"> • If the Blue LED is off, the Computer isn't receiving power. Press and hold the Top and Bottom Tab select buttons to restart computer, (see <i>Menu Panel Components</i> on page 21.) • If the screen is not backlit, press the LCD power button, (see <i>LCD Display Adjustment Buttons</i> on page 22.) • Check the Video In Video Out adapter on the video card (middle plug) connection. • Check that the connectors for the composite video cable at the LCD Screen and the Video card are seated securely.
Fixture behaves erratically or won't respond to DMX control	<ul style="list-style-type: none"> • Verify that the last unit on the DMX link is properly terminated, (see <i>Setting up a Standard DMX Link</i> on page 10). • To control the DL.2 with DMX, you must first enable DMX through the menu System (see <i>DMX_Control Screen</i> on page 28) or the CMA (see <i>DL.3 and DL.2 Media Server Configuration Options</i> on page 276). • If you're using DMX to control the projector using its native menu system, make sure you send a safe command after each button command; otherwise, it's analogous to pressing a button on the projector menu system and not releasing it (see <i>page Projector Control</i> on page 239).

Frequently Asked Questions

How are DL.2 fixture IP addresses determined? In environments that utilize numerous DL.2s, is there risk of IP address conflicts?

DL.2 fixture IP addresses are determined one of two ways:

1. When using DHCP server (like router) IP is generated automatically
2. Without router IP is generated randomly by Windows called *Auto IP*

The generation of IP addresses is handled just as IP addresses are handled for Window networks

Is there a limit to the Ethernet cable run length from the fixtures to the CMA?

Ethernet Cat 5 limit is 100 meters. For longer distances use a router that takes fiber input to Cat 5 output as for typical Ethernet distribution.

What is the longest length High End Systems has tested for camera video distribution?

High End has tested up to 1000 feet of quality Cat 5 without noticing degradation of signal.

Does DL.2 support the file format "MPEG-4"?

MPEG-4 is not currently supported. Convert original graphics and video to MPEG 2.

Chapter 18:

Restoring the System

You can perform a system restore on a DL.3, Axon, or DL.2 Server with your System Restore CD.

A system restore will replace the following components:

- Microsoft Windows Embedded Operating System
- Application

The system restore does not replace the Settings, the Stock content, or User content.

Hardware Requirements



Caution: Contact High End Systems Support (<http://www.highend.com>) PRIOR to initiating a Full Restore!

A system restore can be done to replace the O/S partition of the drive, but should only be done as part of a specified upgrade plan. In that case, the XPe image the fixture shipped with will need to be updated.

All system restore operations require the System Restore CD that ships with each media server. If you have misplaced or damaged this CD, you may contact High End Systems (<http://www.highend.com>) for a replacement.

For a system restore, you will also need:

- External USB CD drive (for DL.3 and DL.2 fixtures only)
- USB keyboard
- Optional USB mouse, which may require the addition of a USB hub for DL.2 fixtures.

Performing the System Restore

Use the following steps to perform a system restore.

1. Plug your USB CD or DVD drive, keyboard, and mouse (optional) into one of the external USB ports on the media server. On DL.3 and DL.2 fixtures, you may need to use a USB hub, although this should only be a requirement if you wish to use a mouse.
2. Power on or reboot the media server. The System Restore menu will display on the Axon monitor or the Menu Screen on DL.3 and DL.2 fixtures.
3. When the fixture boots and the High End Systems logo is seen, press F8 (Asus) or F10 (Intel) to enter the boot menu for the respective motherboard.
4. Select the appropriate boot device and when you see "Hit any key to boot from CD...", press a key on your keyboard.

NOTE: *Pressing Tab on the keyboard when booting the fixture displays the mother-board information.*

5. Allow the System Restore menu to load. Depending on the speed of your USB drive, it will take between 3-5 minutes load. During this time, a number of small windows will appear and disappear. Wait until you see a full-screen menu titled *Axon System Restore Menu* or *DL.2 System Restore Menu*.



6. Using the <Tab> key on your keyboard or using your mouse, select the system restore option or Exit to cancel the operation.
7. The next page will ask you to confirm your selection. Press 'Confirm' and the restore will begin.

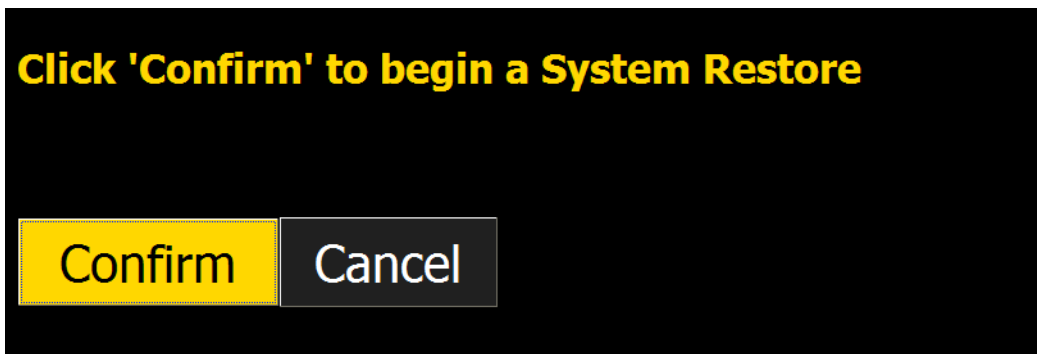

8. Allow the restore to run. This will take between 10-30 minutes depending on the speed of your USB drive. Status will be displayed throughout the restore.

Starting System Restore...

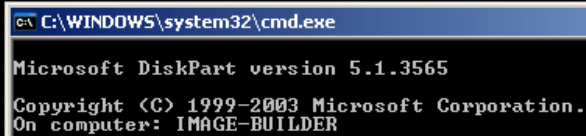

```
C:\WINDOWS\system32\cmd.exe  
Microsoft DiskPart version 5.1.3565  
Copyright (C) 1999-2003 Microsoft Corporation.  
On computer: IMAGE-BUILDER
```

Status:

Partitioning hard drive...

9. When this part of the restore is completed, the media server will automatically restart.

Restore completed successfully! Your machine will restart automatically in 15 seconds.

NOTE: Please wait until after your device restarts to remove the System Restore media and the USB drive.

10. After allowing a few minutes for the media server to reconfigure, the upgrade is complete, you may remove all your external USB devices.

***NOTE:** If you encounter an error, press the Return to Main Menu button and start the recovery process again. An error on the second attempt may indicate a hard drive failure or damaged DVD. In that case, contact High End Systems Technical Support at www.highend.com..*

Error:

**The script has received the error code: 5
From command: cmd /c diskpart /s DL2EWFPart.txt**

Return to Main Menu

Appendix A:

DMX Protocol

DL.3 and DL.2 Digital Lights, and Axon Media Servers utilize the same DMX protocol with the following variations:

- *DL.3 and DL.2 fixtures include channels for motion and camera control*
- *DL.2 and original Axon media servers allow a maximum of four Graphic Objects instead of nine*

The following tables list the parameters and their associated DMX channel number(s). The range for a server on the DMX link depends on the number of Graphic Objects you select for your application. For more detailed information on DMX Protocol, please contact customer support at High End Systems.

NOTE: *Gray shaded parameters are not available in Version 1 Protocol*

DL.3 and DL.2 Version 2 DMX Channel Assignment

DL.3 and DL.2 Mechanical Control

	DMX Chan #
Motion Functions	
Pan	1
	2
Tilt	3
	4
Dimmer	5
Focus	6
Zoom	7
MSpeed	8
Macro	9
Control	10
Camera Functions (Not in DL.3F fixtures)	
Zoom	11
	12
Focus	13
	14
Infrared	15
Camera Shutter	16
White Balance	17
Camera Orientation	18
Camera Effects	19
Red Gain	20
Blue Gain	21

DL.3 and DL.2 Global Control

	DMX Chan #		DMX Chan #
Global Intensity	22	Keystone Top Left X	50
Global Effect 1	23	Keystone Top Left Y	51
Global Effect 1 Modifier 1	24	Keystone Top Right X	52
Global Effect 1 Modifier 2	25	Keystone Top Right Y	53
Global Effect 1 Modifier 3	26	Keystone Bottom Right X	54
Global Effect 2	27	Keystone Bottom Right Y	55
Global Effect 2 Modifier 1	28	Keystone Bottom Left X	56
Global Effect 2 Modifier 2	29	Keystone Bottom Left Y	57
Global Effect 2 Modifier 3	30	Keystone X Ratio	58
Global Effect 3	31	Keystone Y Ratio	59
Global Effect 3 Modifier 1	32		60
Global Effect 3 Modifier 2	33		61
Global Effect 3 Modifier 3	34		62
Global Effect 4	35		63
Global Effect 4 Modifier 1	36		64
Global Effect 4 Modifier 2	37		65
Global Effect 4 Modifier 3	38		66
Global Effect 5	39		67
Global Effect 5 Modifier 1	40	Viewpoint mode	68
Global Effect 5 Modifier 2	41	Viewpoint Position X	69
Global Effect 5 Modifier 3	42		70
Mask Select (default iris)	43	Viewpoint Position Y	71
Mask Size	44		72
Mask Edge	45	Viewpoint Position Z	73
Edge Fade Top	46		74
Edge Fade Right	47	Global Control	75
Edge Fade Bottom	48	Global Control Modifier	76
Edge Fade Left	49		

DL.3 and DL.2 Graphic Object Control

	DMX Channel # <i>(Objects 5-9 not available in DL.2 Servers)</i>								
	Obj.1	Obj.2	Obj.3	Obj.4	Obj.5	Obj.6	Obj.7	Obj.8	Obj.9
Opacity	77	122	167	212	257	302	347	392	437
3-D Object File	78	123	168	213	258	303	348	393	438
Media Folder	79	124	169	214	259	304	349	394	439
Media File	80	125	170	215	260	305	350	395	440
In Frame	81	126	171	216	261	306	351	396	441
	82	127	172	217	262	307	352	397	442
Out Frame	83	128	173	218	263	308	353	398	443
	84	129	174	219	264	309	354	399	444
Play Mode	85	130	175	220	265	310	355	400	445
Play Speed	86	131	176	221	266	311	356	401	446
Sync Type	87	132	177	222	267	312	357	402	447
Sync To	88	133	178	223	268	313	358	403	448
Visual Mode	89	134	179	224	269	314	359	404	449
Visual Mode Modifier 1	90	135	180	225	270	315	360	405	450
Visual Mode Modifier 2	91	136	181	226	271	316	361	406	451
Graphic Effect 1	92	137	182	227	272	317	362	407	452
Effect 1 Modifier 1	93	138	183	228	273	318	363	408	453
Effect 1 Modifier 2	94	139	184	229	274	319	364	409	454
Effect 1 Modifier 3	95	140	185	230	275	320	365	410	455
Graphic Effect 2	96	141	186	231	276	321	366	411	456
Effect 2 Modifier 1	97	142	187	232	277	322	367	412	457
Effect 2 Modifier 2	98	143	188	233	278	323	368	413	458
Effect 2 Modifier 3	99	144	189	234	279	324	369	414	459
Graphic Effect 3	100	145	190	235	280	325	370	415	460
Effect 3 Modifier 1	101	146	191	236	281	326	371	416	461
Effect 3 Modifier 2	102	147	192	237	282	327	372	417	462
Effect 3 Modifier 3	103	148	193	238	283	328	373	418	463
X-axis rotation	104	149	194	239	284	329	374	419	464
	105	150	195	240	285	330	375	420	465
Y -axis rotation	106	151	196	241	286	331	376	421	466
	107	152	197	242	287	332	377	422	467
Z-axis rotation	108	153	198	243	288	333	378	423	468
	109	154	199	244	289	334	379	424	469
Scale X	110	155	200	245	290	335	380	425	470
	111	156	201	246	291	336	381	426	471
Scale Y	112	157	202	247	292	337	382	427	472
	113	158	203	248	293	338	383	428	473
Scale Z	114	159	204	249	294	339	384	429	474
	115	160	205	250	295	340	385	430	475
X Position	116	161	206	251	296	341	386	431	476
	117	162	207	252	297	342	387	432	477
Y Position	118	163	208	253	298	343	388	433	478
	119	164	209	254	299	344	389	434	479
Z Position	120	165	210	255	300	345	390	435	480
	121	166	211	256	301	346	391	436	481

Axon Media Server Version 2 DMX Channel Assignment

NOTE: Gray shaded parameters are not available in Version 1 Protocol

Axon Global Control

	DMX Chan #		DMX Chan #
Global Intensity	1	Keystone Top Left X	29
Global Effect 1	2	Keystone Top Left Y	30
Global Effect 1 Modifier 1	3	Keystone Top Right X	31
Global Effect 1 Modifier 2	4	Keystone Top Right Y	32
Global Effect 1 Modifier 3	5	Keystone Bottom Right X	33
Global Effect 2	6	Keystone Bottom Right Y	34
Global Effect 2 Modifier 1	7	Keystone Bottom Left X	35
Global Effect 2 Modifier 2	8	Keystone Bottom Left Y	36
Global Effect 2 Modifier 3	9	Keystone X Ratio	37
Global Effect 3	10	Keystone Y Ratio	38
Global Effect 3 Modifier 1	11		39
Global Effect 3 Modifier 2	12		40
Global Effect 3 Modifier 3	13		41
Global Effect 4	14		42
Global Effect 4 Modifier 1	15		43
Global Effect 4 Modifier 2	16		44
Global Effect 4 Modifier 3	17		45
Global Effect 5	18		46
Global Effect 5 Modifier 1	19	Viewpoint mode	47
Global Effect 5 Modifier 2	20	Viewpoint Position X	48
Global Effect 5 Modifier 3	21		49
Mask Select (default iris)	22	Viewpoint Position Y	50
Mask Size	23		51
Mask Edge	24	Viewpoint Position Z	52
Edge Fade Top	25		53
Edge Fade Right	26	Global Control	54
Edge Fade Bottom	27	Global Control Modifier	55
Edge Fade Left	28		

Axon Graphic Object Control

	DMX Channel # (<i>Objects 5-9 not available in Original Axon Servers</i>)								
	Obj.1	Obj.2	Obj.3	Obj.4	Obj.5	Obj.6	Obj.7	Obj.8	Obj.9
Opacity	56	101	146	191	236	281	326	371	416
3-D Object File	57	102	147	192	237	282	327	372	417
Media Folder	58	103	148	193	238	283	328	373	418
Media File	59	104	149	194	239	284	329	374	419
In Frame	60	105	150	195	240	285	330	375	420
	61	106	151	196	241	286	331	376	421
Out Frame	62	107	152	197	242	287	332	377	422
	63	108	153	198	243	288	333	378	423
Play Mode	64	109	154	199	244	289	334	379	424
Play Speed	65	110	155	200	245	290	335	380	425
Sync Type	66	111	156	201	246	291	336	381	426
Sync To	67	112	157	202	247	292	337	382	427
Visual Mode	68	113	158	203	248	293	338	383	428
Visual Mode Modifier 1	69	114	159	204	249	294	339	384	429
Visual Mode Modifier 2	70	115	160	205	250	295	340	385	430
Graphic Effect 1	71	116	161	206	251	296	341	386	431
Effect 1 Modifier 1	72	117	162	207	252	297	342	387	432
Effect 1 Modifier 2	73	118	163	208	253	298	343	388	433
Effect 1 Modifier 3	74	119	164	209	254	299	344	389	434
Graphic Effect 2	75	120	165	210	255	300	345	390	435
Effect 2 Modifier 1	76	121	166	211	256	301	346	391	436
Effect 2 Modifier 2	77	122	167	212	257	302	347	392	437
Effect 2 Modifier 3	78	123	168	213	258	303	348	393	438
Graphic Effect 3	79	124	169	214	259	304	349	394	439
Effect 3 Modifier 1	80	125	170	215	260	305	350	395	440
Effect 3 Modifier 2	81	126	171	216	261	306	351	396	441
Effect 3 Modifier 3	82	127	172	217	262	307	352	397	442
X-axis rotation	83	128	173	218	263	308	353	398	443
	84	129	174	219	264	309	354	399	444
Y -axis rotation	85	130	175	220	265	310	355	400	445
	86	131	176	221	266	311	356	401	446
Z-axis rotation	87	132	177	222	267	312	357	402	447
	88	133	178	223	268	313	358	403	448
Scale X	89	134	179	224	269	314	359	404	449
	90	135	180	225	270	315	360	405	450
Scale Y	91	136	181	226	271	316	361	406	451
	92	137	182	227	272	317	362	407	452
Scale Z	93	138	183	228	273	318	363	408	453
	94	139	184	229	274	319	364	409	454
X Position	95	140	185	230	275	320	365	410	455
	96	141	186	231	276	321	366	411	456
Y Position	97	142	187	232	277	322	367	412	457
	98	143	188	233	278	323	368	413	458
Z Position	99	144	189	234	279	324	369	414	459
	100	145	190	235	280	325	370	415	460

Parameter Description and Options

Parameter	Description	DMX Value		Default	
		Dec.	%	Dec.	%
MECHANICAL CONTROL					
Movement Functions (DL.3, DL.2 fixtures only)					
Pan Course	Moves projector head from 0° to 400°	0-	0-100	32768	50
Pan Fine		65535			
Tilt Course	Moves projector head from 0° to 240°	0-	0-100	32768	50
Tilt Fine		65535			
Dimmer	Adjusts the mechanical iris located in front of the projector output lens from closed to open	0-255	0-100	0	0
Focus	Adjusts focus from near to far	0-255	0-100	128	50
Zoom	Adjusts zoom from narrow to wide	0-255	0-100	128	50
MSpeed	See Appendix B for conversion tables	0-255	0-100	0	0
Macro	Reserved for future use	0-255	0-100	0	0
Control Function	Fixture Movement and Camera Control Options (Set Dimmer Channel = 0 except for MSpeed Off)				
<i>(To prevent inadvertent triggering, some Control Function options will not activate until the value has been held for a period of time. A number in parenthesis is the minimum number of consecutive times a DMX value must be received from a controller before the operation begins.)</i>	Pan and Tilt MSpeed off	10-13	NA	0	0
	Reserved	14-19			
	Menu Display Off (5)	20-28			
	Reserved	29			
	Menu Display Dim (5)	30-38			
	Reserved	39			
	Menu Display Bright (5)	40-48			
	Reserved	49			
	Preview	50-58			
	Reserved	59			
	Home All (20)	60-68			
	Reserved	69-79			
	Lamp ON (80)	80-88			
	Reserved	89			
	Lamp OFF (80)	90-98			
	Reserved	99-119			
Shutdown (80)	120-130				

Parameter	Description	DMX Value		Default		
		Dec.	%	Dec.	%	
<p>Control Function</p> <p><i>(To prevent inadvertent triggering, some Control Function options will not activate until the value has been held for a period of time. A number in parenthesis is the minimum number of consecutive times a DMX value must be received from a controller before the operation begins.)</i></p>	Reserved	131-144				
	Graphics System Reset (80)	145-149				
	Camera Reset	150-155				
	Home Pan/Tilt (20)	160-168				
	Reserved	169				
	Home Focus/Zoom/Iris (20)	170-178				
	Reserved	179				
	Using the Projector's Menu System					
	Projector Menu	180-184				
	Projector Up arrow	185-188				
	Projector Down arrow	189-192				
	Projector Left arrow	193-196				
	Projector Right arrow	197-200				
	Store menu selection	201-204				
	Projector Floor Orientation	205-208				
	Projector Ceiling Orientation	209-212				
	Projector Front Projection	213-216			0	0
	Projector Rear Projection	217-220				
	Changing Projector Inputs (Set Dimmer Channel = 0)					
	External RGBHV to Projector	221-224				
	Graphics Engine to Projector (default)	225-228				
	Changing Graphics Engine Inputs (Set Dimmer Channel = 0)					
	S-Video In to Graphic Engine, Internal Camera to Camera Out	229-232				
	Internal Camera to Graphics Engine (default)	233-236				
	Setting Projector Lens Shift (Set Dimmer Channel = 0) <i>Available only in DL.3 and DL.3F fixtures.</i>					
	Lens Shift Engaged (100)	237-240				
	Lens Shift Off (100)	241-244				
	Setting SDI Switching Mode Available only in DL.3 fixtures.					
Camera Routed to SDI Output (100)	245-248					
SDI Input Routed to Capture Card (100)	249-252					
Reserved	253-255	99-100				

Parameter	Description	DMX Value		Default	
		Dec.	%	Dec.	%
Internal Camera Functions (DL.3 and DL.2 fixtures only, reserved in DL.3F fixtures)					
Camera Zoom	Zoom position	0-65535	0-100	32768	50
Camera Focus	Focus position.	0-511	0-100	0	0
	Manual Focus from In (Far End) to Out (Near End)	512-65535			
Infrared Illuminator	Camera's IR sensing off, illuminator off	0-63	0-24	0	0
	Camera's IR sensing on, illuminator off	64-127	25-49		
	Camera's IR sensing on, illuminator scaled across the range from FULL to OFF	128-255	50-100		
Camera Shutter	Auto Exposure = Full Auto	0-63	0-25	0	0
	Auto Exposure = Shutter Priority, Shutter Speed = 30	64-95	26-38		
	Auto Exposure = Shutter Priority, Shutter Speed = 15	96-126	39-49		
	Auto Exposure = Shutter Priority, Shutter Speed = 8	127-157	50-62		
	Auto Exposure = Shutter Priority, Shutter Speed = 4	158-188	63-74		
	Auto Exposure = Shutter Priority, Shutter Speed = 2	189-219	75-86		
	Auto Exposure = Shutter Priority, Shutter Speed = 1	220-255	87-100		
White Balance Mode	Auto Balance	0-63	0-25	0	0
	Indoor	64-95	26-38		
	Outdoor	96-127	39-49		
	Enable Manual Red and Blue gain value adjustment	128-191	50-74		
	Reserved - no change from previous state	192-255	75-100		
Camera Orientation	Flip OFF, Mirror OFF	0-63	0-25	0	0
	Flip OFF, Mirror ON	64-127	26-50		
	Flip ON, Mirror OFF	128-191	51-75		
	Flip ON, Mirror ON	192-255	76-100		
Camera Effects	Freeze Frame OFF, Negative Art, B&W OFF	0-63	0-25	0	0
	Freeze Frame ON, Negative Art, B&W OFF	64-127	26-49		
	Freeze Frame OFF, Negative Art, B&W ON	128-159	50-62		
	Freeze Frame ON, Negative Art, B&W ON	160-191	63-75		
	Freeze Frame OFF, B&W ON	192-223	76-88		
	Freeze Frame ON, B&W ON	224-255	89-100		
Red Gain	Red gain adjustment (Requires White Balance Mode = 128-191)	0-255	0-100	0	0
Blue Gain	Blue Gain adjustment (Requires White Balance Mode = 128-191)	0-255	0-100	0	0

Parameter	Description	DMX Value		Default	
		Dec.	%	Dec.	%
GLOBAL FUNCTIONS					
Global Intensity	Selects intensity level for the composite image	0-255	0-100	255	100
Global Effects					
Global Effect Mode 1, 2, 3, 4 & 5	Off, no effects selection	0	0	0	0
	CMY simulates CMY by subtracting RGB. Reduces color values. Mod1 = cyan, Mod2 = magenta, Mod3 = yellow	1			
	CMY adds to all pixels. Increases color values. Mod1 = cyan, Mod2 = magenta, Mod3 = yellow	2			
	CMY adds to non-black pixels. Increases color values. Mod1 = cyan, Mod2 = magenta, Mod3 = yellow	3			
	RGB Add, all pixels. Mod1 = red, Mod2 = green, Mod3 = blue	4			
	RGB Add 2, all pixels. Mod1 = red, Mod2 = green, Mod3 = blue	5			
	RGB Add, non-black pixels. Mod1 = red, Mod2 = green, Mod3 = blue	6			
	RGB Swap to GBR. Mod1 = red, Mod2 = green, Mod3 = blue.	7			
	RGB Swap to BRG. Mod1 = red, Mod2 = green, Mod3 = blue.	8			
	Solarize 1 If color value < DMX value, invert color. Mod1 = red, Mod2 = green, Mod3 = blue.	9	NA		
	Solarize 2 If color value > DMX, invert color. Mod1 = red, Mod2 = green, Mod3 = blue.	10			
	Solarize 3 If color value < DMX, set color to 0. Mod1 = red, Mod2 = green, Mod3 = blue.	11			
	Solarize 4 If color value > DMX, set color to 0. Mod1 = red, Mod2 = green, Mod3 = blue.	12			
	DotP and Resample. Mod1, Mod2 and Mod3 control resampling.	13			
	Color Cycle, DMX value controls cycle speed. Mod1 = red, Mod2 = green, Mod3 = blue.	14			
	All or nothing. Mod1 = red, Mod2 = green, Mod3 = blue.	15			
	Solid color RGB, Mod1 = red, Mod2 = green, Mod3 = blue.	16			
	RGB Invert Mod1 = red to cyan, Mod2 = green to magenta, Mod3 = blue to yellow	17			
RGB Invert & Swap to GBR. Mod1 = red to magenta, Mod2 = green to yellow, Mod3 = blue to cyan	18				

Parameter	Description	DMX Value		Default	
		Dec.	%	Dec.	%
Global Effect Mode 1, 2, 3, 4 & 5	RGB Invert & Swap to BRG. Mod1 = red to yellow, Mod2 = green to cyan, Mod3 = blue to magenta	19			
	Edge Detect Color. Mod1 = horizontal size, Mod2 = vertical search size, Mod3 = comparison threshold	20			
	Edge Detect B/W. Mod1 = horizontal size, Mod2 = vertical search size, Mod3 = comparison threshold	21			
	Texture Ripple, Horizontal. Mod1 = size, Mod2 = rate, Mod3 = offset	22			
	Texture Ripple, Vertical. Mod1 = size, Mod2 = rate, Mod3 = offset	23			
	Texture Ripple, Circular. Mod1 = size, Mod2 = rate, Mod3 = offset	24			
	Texture Ripple, Asymmetrical Circular. Mod1 = size, Mod2 = rate, Mod3 = offset	25			
	Transparent Color Fine. Select key color. Mod1 = red, Mod2 = green, Mod3 = blue	26			
	Transparent Color Medium. Select key color. Mod1 = red, Mod2 = green, Mod3 = blue	27			
	Transparent Color Coarse. Select key color. Mod1 = red, Mod2 = green, Mod3 = blue	28	NA	0	0
	Transparent Color Invert, Fine. Select key color. Mod1 = red, Mod2 = green, Mod3 = blue	29			
	Transparent Color Invert, Medium. Select key color. Mod1 = red, Mod2 = green, Mod3 = blue	30			
	Transparent Color Invert, Coarse. Select key color. Mod1 = red, Mod2 = green, Mod3 = blue	31			
	Scan Line. Mod1 selects scan line as texture, Mod2 fades from original image to converted image, Mod3 not used, reserved	32			
	Transparent wipes. Mod1 = width and transparent area, Mod2 = center of transparent area, Mod3 = transparency mode	33			
	Pixel Twist. Mod1 = x twist center, Mod2 = y twist center, Mod3 = direction and amount of twist	34			
	Picture-in-Picture. Mod1 = x subpicture center, Mod2 = y subpicture center, Mod3 = subpicture size	35			
	Magnifying lens, Mod1 = x lens center, Mod2 = y lens center, Mod3 lens size	36			
Magnifying lens 2, Mod1 = x lens center, Mod2 = y lens center, Mod3 = lens size	37				

Parameter	Description	DMX Value		Default	
		Dec.	%	Dec.	%
Global Effect Mode 1, 2, 3, 4 & 5	Cartoon Edge. Mod1 = Edge Color, Mod2 = Contrast, Mod3 = Edge detection sensitivity	38			
	Color DeConverge. Mod1 = Moves red up, Mod2 = Moves green down and right, Mod3 = Moves blue down and left	39			
	Horizontal Mirror, Mod1 = mirror center, Mod2 and Mod3 not used	40			
	RGB Swap to BGR. Mod1 = red, Mod2 = green, Mod3 = blue	41			
	RGB Swap to RBG. Mod1 = red, Mod2 = green, Mod3 = blue	42			
	RGB Swap to GRB. Mod1 = red, Mod2 = green, Mod3 = blue	43			
	Colorize Gray Scale maps pixel intensity to color. Mod1 = Color Scheme selection, Mod2 = Zero intensity point in color scheme, Mod3 = Fading	44			
	Intensity key turns pixels of selected intensity transparent: Mod1 = Color Scheme, Mod2 = Intensity bandwidth, Mod3 = Transparency level	45			
	Raindrop effect. Mod1 = size/speed, Mod2 = position, and Mod3 = raindrop rate.	46			
	RGB Scale. Mod1 = scale red, Mod2 = scale green, Mod3 = scale blue. Maximum of Mod1, Mod2 and Mod3 sets overall color range	47	NA	0	0
	Tiling on. Mod1 = x-axis tile scale, Mod2 = y-axis tile scaler, Mod3 = space between lines	48			
	Color to Alpha. Mod1 = red to alpha, Mod2 = green to alpha, Mod3 = blue to alpha	49			
	Color to Alpha, Inverted. Mod1 = cyan to alpha, Mod2 = magenta to alpha, Mod3 = yellow to alpha	50			
	Texture Mixing. Mod1 = Source media file, Mod2 = Source effect level, Mod3 = Crossfade from original to source texture	51			
	Image Scale and Rotate. Mod1 = scales image, Mod2 = rotation angle, Mod3 = rotation speed	52			
	Film Roll. Mod1 = horizontal roll speed, Mod2 = vertical roll speed, Mod3 = Image scale	53			
	Pixelate. Mod1 = Amount of pixelation, Mod2 = horizontal scale, Mod3 = vertical scale	54			
	Faux LED. Mod1 = "LED" size, Mod2 = spacing, Mod 3 = color peaking	55			
Faux Tile. Mod1 = Tile size, Mod2 = spacing, Mod3 = color peaking	56				

Parameter	Description	DMX Value		Default	
		Dec.	%	Dec.	%
Global Effect Mode 1, 2, 3, 4 & 5	Fuzzifier. Mod1 = Horizontal distance, Mod2 = vertical distance, Mod3 = fuzz decay	57	NA	0	0
	Drop Shadow. Mod1 = horizontal size, Mod2 = vertical size, Mod3 = shadow opacity	58			
	Zoom Blur. Mod1 = horizontal position center, Mod2 = vertical position center, Mod3 = zoom	59			
	Chroma Shift. Mod1 = horizontal shift, Mod2 = vertical shift, Mod3 = Scale	60			
	ShakeNBake. Mod1 = horizontal shake, Mod2 = vertical shake, Mod3 = Scale	61			
	Slats, Vertical. Mod1 = number, Mod2 = displacement, Mod3 = fade	62			
	Slats, Horizontal. Mod1 = number, Mod2 = displacement, Mod3 = fade	63			
	Reserved. Defaults to effect mode = 0	64-79			
	Downward Vertical Streaks. Mod1 = start position, Mod2 = streak angle, Mod3 = fade	80			
	Gaussian Blur. Mod1 = sample distance, Mod2 = filter pass number, Mod3 = curve shape	81			
	Sharpen. Mod1 = sample distance, Mod2 = number of filter passes, Mod3 = sharpen scale	82			
	Flip, Mod1 = flip horizontally, Mod2 = flip vertically, Mod3 = not used	83			
	UV to Gray. Mod1 = U coordinate, Mod2 = V coordinate, Mod3 = Tolerance	84			
	UV to Transparent. Mod1 = U coordinate, Mod2 = V coordinate, Mod3 = Tolerance	85			
	UV Select to Transparent. Mod1 = U coordinate, Mod2 = V coordinate, Mod3 = Tolerance	86			
	HS to Gray. Mod1 = H coordinate, Mod2 = S coordinate, Mod3 = Tolerance	87			
	HS to Transparent. Mod1 = H coordinate, Mod2 = S coordinate, Mod3 = Tolerance	88			
	HSSelect to Transparent. Mod1 = H coordinate, Mod2 = S coordinate, Mod3 = Tolerance	89			
	Texture Shift. Mod1 = horizontal shift, Mod2 = vertical shift, Mod3 = colors and scale	90			
	Lens Grid. Mod1 = magnification, Mod2 = edge shading, Mod3 = number of lenses	91			
	Edge Detect BW2. Mod1 = Sample distance, Mod2 = edge threshold comparison, Mod3 = detected edge scaler	92			

Parameter	Description	DMX Value		Default	
		Dec.	%	Dec.	%
Global Effect Mode 1, 2, 3, 4 & 5	Film Burn. Mod1 = burn/unburn rate, Mod2 = film blackening, Mod3 = burn pattern	93			
	Film Noise. Mod1 = noise rate, Mod2 = push to sepia with/without jitter, Mod3 = noise level	94			
	Particle System 1. Mod1 = emitter type, Mod2 = trail length, Mod3 = particle acceleration	95			
	Particle System 2. Mod1 = number of particles, Mod2 = size of particles, Mod3 = emitter size	96			
	Particle System 3. Mod1 = particle initial velocity, Mod2 = particle rotation, Mod3 = particle life	97			
	Prism. Mod1 = number of facets, Mod2 = index of refraction, Mod3 = rotation	98			
	Gaussian Halo. Mod1 = sample distance, Mod2 = number of filter passes, Mod3 = shape of Gaussian curve	99			
	Scene Change Detect Mod1 = Scale RGB, Mod2 = RGB to Alpha, Mod3 = Scale color after alpha applied	100			
	Xy Luminance Scaling. Mod1 = scale luminance (default 64), Mod2 = scale x (default 128), Mod3 = scale y (default 128)	101			
	Prerotation Translation. Mod1 = translate x, Mod2 = translate y, Mod3 = translate z.	102	NA	0	0
	Digital MSpeed. Mod1 = rotation mspeed. Mod2 = scaling mspeed. Mod3 = position mspeed	103			
	Reserved. Defaults to effect mode = 0	104-127			
	Mask Color. Mod1 = red, Mod2 = green, Mod3 = blue	128			
	Edge Fade color. Mod1 = red, Mod2 = green, Mod3 = blue	129			
	Mask Color and Edge Fade Color. Mod1 = red, Mod2 = green, Mod3 = blue	130			
	Background Color. Mod1 = red, Mod2 = green, Mod3 = blue	131			
	Background Color Cycle. Mod1 = red speed, Mod2 = green speed, Mod3 = blue speed	132			
	Edge Fade Profile. Mod1 = Mode, Mod2 = Profile, Mod3 = Source	133			
	Collage. Mod1 = grid style selection, Mod2 = grid portion displayed, Mod3 = edge blend adjustment	134			
	Curve Correction, Vertical Convex Cylinder. Mod1 = correction, Mod2 = adjusts vertical centerpoint, Mod3 = Not used	135			

Parameter	Description	DMX Value		Default	
		Dec.	%	Dec.	%
Global Effect Mode 1, 2, 3, 4 & 5	Curve Correction, Vertical Concave Cylinder. Mod1 = correction, Mod2 = adjusts vertical centerpoint, Mod3 = Not used	136			
	Curve Correction, Vertical Inside Corner. Mod1 = correction, Mod2 = adjusts vertical centerpoint, Mod3 = adjusts horizontal centerpoint	137			
	Curve Correction, Vertical Outside Corner. Mod1 = correction, Mod2 = adjusts vertical centerpoint, Mod3 = adjusts horizontal centerpoint	138			
	Curved Surface, Outside Sphere. Mod1 = correction, Mod2 = adjusts vertical centerpoint, Mod3 = adjusts horizontal centerpoint	139			
	Curved Surface, Inside Sphere. Mod1 = correction, Mod2 = adjusts vertical centerpoint, Mod3 = adjusts horizontal centerpoint.	140			
	Enhanced Collage Generator. Mod1 = grid style selection, Mod2 = grid portion displayed, Mod3 = edge blend.	141			
	Spherical Mapping. Outside. Mod1 = longitude angle, Mod2 = latitude angle, Mod3 = center latitude.	142			
	Spherical Mapping. Inside. Mod1 = longitude angle, Mod2 = latitude angle, Mod3 = center latitude.	143	NA	0	0
	Mattes. Mod1 = Mode, Mod2 = Matte Select, Mod3 = texture source	144			
	Enhanced Collage Wrap. Mod1 = array type, Mod2 = display cell, Mod3 = edge blending	145			
	Segmented Collage Generator. Mod1 = array type, Mod2 = display cell, Mod3 = edge blending	146			
	Segmented Collage Generator Wrap. Mod1 = array type, Mod2 = display cell, Mod3 = edge blending	147			
	Output Correction, Horizontal Convex Cylinder. Mod1 = correction, Mod2 = adjusts horizontal centerpoint, Mod3 = Not used	148			
	Output Correction, Horizontal Concave Cylinder. Mod1 = correction, Mod2 = adjusts horizontal centerpoint, Mod3 = Not used	149			
	Collage Gen 3, improves blending. Otherwise, the same as global effect 141. Mod1 = grid style selection, Mod2 = grid portion displayed, Mod3 = edge blend	150			
Collage Gen 3 Wrap, improved blending. Otherwise, the same as global effect 145. Mod1 = grid style selection, Mod2 = grid portion displayed, Mod3 = edge blend	151				

Parameter	Description	DMX Value		Default	
		Dec.	%	Dec.	%
Global Effect Mode 1, 2, 3, 4 & 5	Segmented Collage Gen 3, improves edge blending. Otherwise, the same as global effect 146. Mod1 = grid style selection, Mod2 = grid portion displayed, Mod3 = edge blend	152	NA	0	0
	Segmented Collage Gen 3 Wrap, improves edge blending. Otherwise, the same as global effect 147. Mod1 = grid style selection, Mod2 = grid portion displayed, Mod3 = edge blend.	153			
	Reserved. Defaults to effect 0	152-252			
	Special value used with global spherical mapping effect 142. Defaults to 0 otherwise.	253			
	Special value used with global spherical mapping effect 142. Defaults to 0 otherwise.	254			
	Pan and Scan. Mod1 = horizontal position, Mod2 = vertical position, Mod3 = Zoom	255			
Global Effect Modifier 1	These Modifier parameters adjust the option selected in the corresponding channel of each of the five Global Effects Modes. The type of adjustment and the default value depends on the particular effect option.	0-255	0-100	NA	NA
Global Effect Modifier 2	NOTE: Setting the Graphic Effect Mode DMX = 253 or 254 activates specific spherical mapping control options for Modifier parameters. For more about Modifier parameter functionality, see <i>Global Effect Mode Channels</i> on page 112, and specific effect options listed alphabetically in <i>Chapter 13</i> .	0-255	0-100		
Global Effect Modifier 3		0-255	0-100		

Parameter	Description	DMX Value		Default		
		Dec.	%	Dec.	%	
Global Mask						
Mask Select	Static Masks					
	Round <i>iris</i> closing from outside in	0	0			
	Round <i>iris</i> closing from inside out	1				
	Rectangle closing from outside in	2				
	Rectangle closing from inside out	3				
	Checkerboard, variation 1	4				
	Checkerboard, variation 2	5				
	Radial wipe, variation 1	6				
	Radial wipe, variation 2	7				
	Radial wipe, variation 3	8				
	Radial wipe, variation 4	9				
	Triangles, variation 1	10				
	Triangles, variation 2	11				
	Rectangular wrap	12				
	Tiles closing in	13				
	Horizontal doors, closing	14				
	Horizontal doors closing from opposing sides	15			0	0
	Vertical doors closing from outside in	16			NA	
	Vertical wipe closing from inside out	17				
	Rectangular tiles closing from inside out 1	18				
	Rectangular tiles closing from inside out 2	19				
	Vertical panels closing from outside in 1	20				
	Vertical panels closing from outside in 2	21				
	Vertical diamonds 1	22				
	Vertical diamonds 2	23				
	Horizontal diamonds 1	24				
	Horizontal diamonds 2	25				
	Pinwheel	26				
	Oval Iris closing from outside in	27				
	Oval Iris closing from inside out	28				
	Oscillating iris closing from outside in	29				
Artistic Iris	30					
Reserved for other installed masks, defaults to 0	31-127					

Parameter	Description	DMX Value		Default		
		Dec.	%	Dec.	%	
Mask Select	Strobing Masks					
	Periodic strobe, round “iris” mask closing outside in.	128	50			
	Round <i>iris</i> closing from inside out	129				
	Rectangle closing from outside in	130				
	Rectangle closing from inside out	131				
	Checkerboard, variation 1	132				
	Checkerboard, variation 2	133				
	Radial wipe, variation 1	134				
	Radial wipe, variation 2	135				
	Radial wipe, variation 3	136				
	Radial wipe, variation 4	137				
	Triangles, variation 1	138				
	Triangles, variation 2	139				
	Rectangular wrap	140				
	Tiles closing in	141				
	Horizontal doors, closing	142				
	Horizontal doors closing from opposing sides	143		0	0	
	Vertical doors closing from outside in	144	NA			
	Vertical wipe closing from inside out	145				
	Rectangular tiles closing from inside out 1	146				
	Rectangular tiles closing from inside out 2	147				
	Vertical panels closing from outside in 1	148				
	Vertical panels closing from outside in 2	149				
	Vertical diamonds 1	150				
	Vertical diamonds 2	151				
	Horizontal diamonds 1	152				
	Horizontal diamonds 2	153				
Pinwheel	154					
Oval Iris closing from outside in	155					
Oval Iris closing from inside out	156					
Oscillating iris closing from outside in	157					
Animated Dynamic Iris	158					
Reserved for other strobing installed masks	159-255					
Mask Size	Adjusts mask size from fully closed to open	0-255	0-100	255	100	
Mask Edge Fade	Hard edge to faded edge when Mask Select = 0-127. Strobe rate control from fastest to slowest when Mask Select parameter value = 128-255	0-255	0-100	0	0	

Parameter	Description	DMX Value		Default	
		Dec.	%	Dec.	%
Global Image Edge Fade					
Image Edge Fade, Top	Adjusts the image's top edge diffusion from hard edge (0) to maximum fade (255)	0-255	0-100	0	0
Image Edge Fade, Right	Adjusts the image's right edge diffusion from hard edge (0) to maximum fade (255)	0-255	0-100	0	0
Image Edge Fade, Bottom	Adjusts the image's bottom edge diffusion from hard edge (0) to maximum fade (255)	0-255	0-100	0	0
Image Edge Fade, Left	Adjusts the image's left edge diffusion from hard edge (0) to maximum fade (255)	0-255	0-100	0	0
Global Keystone Correction					
Keystone X Top Left	Moves top left corner x value to center	0-255	0-100	0	0
Keystone Y Top Left	Moves top left corner y value to center	0-255	0-100	0	0
Keystone X Top Right	Moves top right corner x value to center	0-255	0-100	0	0
Keystone Y Top Right	Moves top right corner y value to center	0-255	0-100	0	0
Keystone X Bottom Right	Moves bottom right corner x value to center	0-255	0-100	0	0
Keystone Y Bottom Right	Moves bottom right corner y value to center	0-255	0-100	0	0
Keystone X Bottom Left	Moves bottom left corner x value to center	0-255	0-100	0	0
Keystone Y Bottom Left	Moves bottom left corner y value to center	0-255	0-100	0	0
Keystone X Ratio	Compresses and expands image horizontally	0-255	0-100	128	50
Keystone Y Ratio	Compresses or expands image vertically	0-255	0-100	128	50
Global Framing					
Framing X Top Left	Clip image from top left corner x value	0-255	0-100	0	0
Framing Y Top Left	Clip image from top left corner y value	0-255	0-100	0	0
Framing X Top Right	Clip image from top right corner x value	0-255	0-100	0	0
Framing Y Top Right	Clip image from top right corner y value	0-255	0-100	0	0

Parameter	Description	DMX Value		Default			
		Dec.	%	Dec.	%		
Framing X Bottom Right	Clip image from bottom right corner x value	0-255	0-100	0	0		
Framing Y Bottom Right	Clip image from bottom right corner y value	0-255	0-100	0	0		
Framing X Bottom Left	Clip image from bottom left corner x value	0-255	0-100	0	0		
Framing Bottom Left	Clip image from bottom left corner y value	0-255	0-100	0	0		
Global Viewpoint							
Viewpoint Mode	Perspective View, Spherical Coordinates				0	0	
	Look at point: center of universe		0	0			
	Look at point: graphic 1		1	NA			
	Look at point: graphic 2		2				
	Look at point: graphic 3		3				
	Perspective View, Cartesian Coordinates						NA
	Look at point: center of universe		4				
	Look at point: graphic 1		5				
	Look at point: graphic 2		6				
	Look at point: graphic 3		7				
	Orthogonal View, Cartesian Coordinates						NA
	Look at point: center of universe		8				
	Look at point: graphic 1		9				
	Look at point: graphic 2		10				
	Look at point: graphic 3		11				
	Perspective View, Spherical Coordinates						NA
	Look at point: graphic 4		12				
	Look at point: graphic 5		13				
	Look at point: graphic 6		14				
	Look at point: graphic 7		15				
	Look at point: graphic 8		16				
	Look at point: graphic 9		17				
	Perspective View, Cartesian Coordinates						NA
Look at point: graphic 4		18					
Look at point: graphic 5		19					
Look at point: graphic 6		20					
Look at point: graphic 7		21					
Look at point: graphic 8		22					
Look at point: graphic 9		23					

Parameter	Description	DMX Value		Default		
		Dec.	%	Dec.	%	
Viewpoint Mode	Orthogonal View, Cartesian Coordinates					
	Look at point: graphic 4	24	NA	0	0	
	Look at point: graphic 5	25				
	Look at point: graphic 6	26				
	Look at point: graphic 7	27				
	Look at point: graphic 8	28				
	Look at point: graphic 9	29				
	Additional Effects					
	Reserved	30-127				
	Variable Edge Blend	128				
Reserved	12-255					
Viewpoint X Position	Maximum horizontal angle clockwise	0	0-	32768	50	
	Center	32768	50			
	Maximum horizontal angle counterclockwise	65535	100			
Viewpoint Y Position	Maximum Vertical angle clockwise	0	0-	32768	50	
	Center	32768	50			
	Maximum Vertical angle counterclockwise	65535	100			
Viewpoint Z Position (Zoom)	Maximum distance from origin in front of view target	0	0	32768	50	
	Center	32768	50			
	Maximum distance from origin behind view target	65535	100			
Global Control						
Global Control <i>(A number in parenthesis is the minimum number of consecutive times a DMX value must be received from a controller before the operation begins.)</i>	No control selected. Safe	0	0	NA	0	0
	Reserved	1-119				
	Axon Shutdown when Intensity = 0 (80)	120-130				
	Reserved	131-144				
	Reset when Intensity = 0 (80)	145-149				
	Reserved	150-251				
	Spherical Control Statistics (Global Control Modifier Parameter selects text color)	252				
	All-in-One displays an array that includes each layer's output, each layer's combined output, and any spherical effects applied.	253				
	Performance Statistics	254				
	On-screen Statistics	255				
Reserved	4-255					

Parameter	Description	DMX Value		Default		
		Dec.	%	Dec.	%	
Global Control Modifier	All-in-one Combined Quadrant (Global Control Channel = 253)					
	Displays each defined Graphic Object with no effects applied	0	0	0	0	
	Displays the first effect (if any) applied to any defined Graphic Object	1	NA			
	Displays the second effect (if any) applied to any defined Graphic Object	2				
	Displays the third effect (if any) applied to any defined Graphic Object	3				
	Displays the fourth effect (if any) applied to any defined Graphic Object	4				
	Displays the fifth effect (if any) applied to any defined Graphic Object	5				
	Displays the sixth effect (if any) applied to any defined Graphic Object	6				
	Displays the seventh effect (if any) applied to any defined Graphic Object	7				
	Displays the eighth effect (if any) applied to any defined Graphic Object	8				
	Displays the ninth effect (if any) applied to any defined Graphic Object	9				
	Reserved. Reverts to raw image display	10-255				
	On-screen Statistics (Global Control Channel = 252 or 255)					
	Text color = gray	0	NA			
	Text color = red	1				
	Text color = blue	2				
	Text color = green	3				
	On-screen Statistics (Global Control Channel = 254)					
	Controls opacity from full to transparent	0-255	NA			

Parameter	Description	DMX Value		Default	
		Dec.	%	Dec.	%
GRAPHIC OBJECT FUNCTIONS					
Opacity	Selects transparency level from completely transparent (0) to opaque (255)	0-255	0-100	0	0
Graphic Content Definition					
3-D Object File	No selection	0	0	1	1
	First Stock 3-D Object (flat plane)	1	1		
	Additional Stock 3-D Objects	2-149	NA		
	First User 3-D Objects	150			
	Additional User Objects	151-255			
Media Folder	No selection	0	NA	0	0
	HES Folder 1	1			
	HES Folders 2- 40	2-40			
	First User Folder 41	41			
	User Folders 42-239	42-239			
	Reserved	240-254			
	Video capture. The Media File parameter selects S Video or SDI input. Other Media file values are ignored. NOTE: SDI available with DL.3 and Axon only.	255			
Media File Selection (Media Folder Channel = 0-254)				0	0
No selection	0	0			
First Media File	1	NA			
Additional Media Files 2-255	2-255				
Video Capture Selection (Media Folder Channel = 0-255)				0	0
No Video capture source selected	0	0			
SVideo capture source	1	NA			
Standard Definition (SD) SDI capture source, if installed	2				
SVideo capture source 2, if installed. Available with Axon server only	3				
SD SDI capture source 2, if installed. Available with Axon server only	4				
High Definition (HD) SDI source 1, if installed. Available with Axon server only	5				
High Definition (HD) SDI source 2, if installed. Available with Axon server only	6				
High Definition (HD) SDI source 3, if installed. Available with Axon server only	7				
High Definition (HD) SDI source 4, if installed. Available with Axon server only	8				

Parameter	Description	DMX Value		Default	
		Dec.	%	Dec.	%
In Frame	Defines the beginning of a media file segment as a percentage of the movie length	0-65535	0-100	0	0
Out Frame	Defines the end of a Media File segment as a percentage of the movie length	0-65535	0-100	65535	100
Play Mode	Play forward looping continuously	0	0	0	0
	Play forward once and hold on the last frame	1	NA		
	Pause	2			
	Play forward if opacity > 0, hold on last frame	3			
	Play forward if opacity > 0, looping continuously	4			
	Pause and rewind to In Frame	5			
	Scrub (Display) the selected In Frame	6			
	Scrub (Display) the selected Out Frame	7			
	Scrub (Display) the selected In Frame with statistics	8			
	Scrub (Display) the selected Out Frame with statistics	9			
Reserved	10-255	3-100			
Play Speed	Normal Speed	0	0	128	50
	Slow speeds from slowest toward normal	1-127	1-49		
	Normal Speed	128	50		
	Faster than Normal to Fastest	129-255	51-100		
Graphic Synchronization					
Sync Type	No selection	0	0	0	0
	Sync to Graphic 1 movie time	1	NA		
	Sync to Graphic 2 movie time	2			
	Sync to Graphic 3 movie time	3			
	Sync to Object 1 rotation	4			
	Sync to Object 2 rotation	5			
	Sync to Object 3 rotation	6			
	Sync to reverse Object 1 rotation	7			
	Sync to reverse Object 2 rotation	8			
	Sync to reverse Object 3 rotation	9			
	Sync to Graphic 1 movie time and Object 1 rotation	10			
	Sync to Graphic 2 movie time and Object 2 rotation	11			
	Sync to Graphic 3 movie time and Object 3 rotation	12			
	Sync to Graphic 1 movie time and Object 1 reverse rotation	13			
Sync to Graphic 1 movie time and Object 2 reverse rotation	14				

Parameter	Description	DMX Value		Default	
		Dec.	%	Dec.	%
Sync Type	Sync to Graphic 1 movie time and Object 3 reverse rotation	15	NA	0	0
	Sync to Graphic 4 movie time	16			
	Sync to Graphic 5 movie time	17			
	Sync to Graphic 6 movie time	18			
	Sync to Graphic 7 movie time	19			
	Sync to Graphic 8 movie time	20			
	Sync to Graphic 9 movie time	21			
	Sync to Object 4 rotation	22			
	Sync to Object 5 rotation	23			
	Sync to Object 6 rotation	24			
	Sync to Object 7 rotation	25			
	Sync to Object 8 rotation	26			
	Sync to Object 9 rotation	27			
	Sync to Object 4 reverse rotation	28			
	Sync to Object 5 reverse rotation	29			
	Sync to Object 6 reverse rotation	30			
	Sync to Object 7 reverse rotation	31			
	Sync to Object 8 reverse rotation	32			
	Sync to Object 9 reverse rotation	33			
	Sync to Graphic 4 movie time and Object 4 rotation	34			
	Sync to Graphic 5 movie time and Object 5 rotation	35			
	Sync to Graphic 6 movie time and Object 6 rotation	36			
	Sync to Graphic 7 movie time and Object 7 rotation	37			
	Sync to Graphic 8 movie time and Object 8 rotation	38			
	Sync to Graphic 9 movie time and Object 9 rotation	39			
	Sync to Graphic 4 movie time and Object 4 reverse rotation	40			
	Sync to Graphic 5 movie time and Object 5 reverse rotation	41			
	Sync to Graphic 6 movie time and Object 6 reverse rotation	42			
	Sync to Graphic 7 movie time and Object 7 reverse rotation	43			
	Sync to Graphic 8 movie time and Object 8 reverse rotation	44			
Sync to Graphic 9 movie time and Object 9 reverse rotation	45				
Reserved. Defaults to mode 0, no selection.	16- 255				

Parameter	Description	DMX Value		Default		
		Dec.	%	Dec.	%	
Sync To	No Selection	0	NA	0	0	
	Sync to Fixture ID Number 1	1				
	Sync to Fixture ID Number 2	2				
				
	Sync to Fixture Number 254	254				
	Sync to Fixture ID Number 255	255				
Graphic Object Effects						
Visual Mode	Off. No visual mode processing applied to output.	0	0	NA	0	0
	Content Optimization. Mod1 = black level, Mod2 = contrast.	1				
	Sepia tones. Mod1 fades from original color to sepia colors. Mod2 controls saturation.	2				
	Red tones. Mod1 fades from original color to red tones. Mod2 controls saturation.	3				
	Gray maker. Mod1 compresses colors to shades of gray. Mod2 adjusts contrast	4				
	Gray maker2. Always gray. Mod1 = brightness, Mod2 = contrast	5				
	Posterizer. Mod1 reduces color detail. Mod2 adjusts contrast.	6				
	Color to Black & White. Mod1 fades color RGB @ 0 to B/W @ 50% to white @100%. Mod2 = not used.	7				
	Fire Gradient, Mod1fades original to converted Mod2 not used, reserved.	8				
	Negative Art. Mod1 fades from original image to converted image, Mod2 subtracts red from 0-128, subtracts green from 129-255.	9				
	Exposure Control. Mod1 adjusts color contrast, Mod2 adjusts color shift	10				
	Invert B&W, Keep Color. Mod1 = black comparison level, Mod2 = white comparison level	11				
	Texture Mixing. Mod1 = Source media file, Mod2 = Crossfade from original to source texture	12				
	Image Scale and Rotate. Mod1 = image scale, Mod2 = rotation angle.	13				
	Film Roll. Mod1 = horizontal roll speed, Mod2 = Vertical roll speed	14				
	Pixelate. Mod1 = amount of pixelation, Mod 2 not used	15				
	Faux LED. Mod1 = "LED" size, Mod2 = spacing	16				
Faux Tile. Mod1 = Tile size, Mod2 = spacing	17					

Parameter	Description	DMX Value		Default	
		Dec.	%	Dec.	%
Visual Mode	Fuzzifier. Mod1 = x-axis distance, Mod2 = y-axis distance	18	NA	0	0
	Drop Shadow. Mod1 = horizontal shadow size, Mod2 = vertical shadow size	19			
	Zoom Blur. Mod1 = horizontal position center, Mod2 = vertical position center	20			
	Chroma Shift. Mod1 = horizontal shift, Mod2 = vertical shift	21			
	ShakeNBake. Mod1 = horizontal shake, Mod2 = vertical shake	22			
	CTO/CTB. Mod1 = push to orange, Mod2 = push to blue	23			
	Flip. Mod1 = flip horizontally, Mod2 = flip vertically	24			
	Reserved (Defaults to 0)	25-254			
	Pan and Scan. Mod1 = horizontal position, Mod2 = vertical position	255			
Visual Mode Modifier 1	Adjusts option selected in the Visual Mode Parameter	0-255	0-100	NA	NA
Visual Mode Modifier 2	The type of adjustment and the default value depends on the particular visual mode option selected. For more about Visual Mode Modifier parameter functionality, see, <i>Visual Mode</i> on page 80 and <i>Visual Mode Options</i> on page 82.	0-255	0-100		
Graphic Effect Mode 1, 2 & 3	Off, no effects selection	0	0 NA	0	0
	CMY simulates CMY by subtracting RGB (reduces color values) Mod1 = cyan, Mod2 = magenta, Mod3 = yellow	1			
	CMY Add to All Pixels increases color values. Mod1 = cyan, Mod2 = magenta, Mod3 = yellow	2			
	CMY Add to Non-black Pixels increases color values. Mod1 = cyan, Mod2 = magenta, Mod3 = yellow	3			
	RGB Add All Pixels. Mod1 = red, Mod2 = green, Mod3 = blue	4			
	RGB Add 2 All Pixels. Mod1 = red, Mod2 = green, Mod3 = blue	5			
	RGB Add, non-black pixels. Mod1 = red, Mod2 = green, Mod3 = blue	6			
	RGB Swap to GBR. Mod1 = red, Mod2 = green, Mod3 = blue.	7			
	RGB Swap to BRG. Mod1 = red, Mod2 = green, Mod3 = blue.	8			
	Solarize 1 (if color value < DMX value, invert color). Mod1 = red, Mod2 = green, Mod3 = blue.	9			
	Solarize 2 (if color value > DMX, invert color). Mod1 = red, Mod2 = green, Mod3 = blue.	10			

Parameter	Description	DMX Value		Default	
		Dec.	%	Dec.	%
Graphic Effect Mode 1, 2 & 3	Solarize (if color value < DMX, color = 0). Mod1 = red, Mod2 = green, Mod3 = blue.	11			
	Solarize 4 (if color value > DMX, color = 0). Mod1 = red, Mod2 = green, Mod3 = blue.	12			
	DotP and Resample. Mod1, Mod2 and Mod3 control resampling.	13			
	Color Cycle (DMX value controls cycle speed) Mod1 = red, Mod2 = green, Mod3 = blue.	14			
	All or Nothing (Color value greater than Mod value, color = 255, else color = 0) Mod1 = red, Mod2 = green, Mod3 = blue.	15			
	Solid Color RGB. Mod1 = red, Mod2 = green, Mod3 = blue.	16			
	RGB Invert. Mod1 = red to cyan, Mod2 = green to magenta, Mod3 = blue to yellow	17			
	RGB Invert & Swap to GBR. Mod1 = red to magenta, Mod2 = green to yellow, Mod3 = blue to cyan	18			
	RGB Invert & Swap to BRG. Mod1 = red to yellow, Mod2 = green to cyan, Mod3 = blue to magenta	19			
	Edge Detect Color. Mod1 = horizontal size, Mod2 = vertical search size, Mod3 = comparison threshold	20	NA	0	0
	Edge Detect B/W Mod1 = horizontal size, Mod2 = vertical search size, Mod3 = comparison threshold	21			
	Texture Ripple, Horizontal. Mod1 = size, Mod2 = rate, Mod3 = offset	22			
	Texture Ripple, Vertical. Mod1 = size, Mod2 = rate, Mod3 = offset	23			
	Texture Ripple, Circular. Mod1 = size, Mod2 = rate, Mod3 = offset	24			
	Texture Ripple, Asymmetrical Circular. Mod1 = size, Mod2 = rate, Mod3 = offset	25			
	Transparent Color Fine. Select key color. Mod1 = red, Mod2 = green, Mod3 = blue	26			
	Transparent Color Medium. Select key color. Mod1 = red, Mod2 = green, Mod3 = blue	27			
	Transparent Color Coarse. Select key color. Mod1 = red, Mod2 = green, Mod3 = blue	28			
	Transparent Color Invert, Fine. Select key color. Mod1 = red, Mod2 = green, Mod3 = blue	29			
	Transparent Color Invert, Medium. Select key color. Mod1 = red, Mod2 = green, Mod3 = blue	30			

Parameter	Description	DMX Value		Default	
		Dec.	%	Dec.	%
Graphic Effect Mode 1, 2 & 3	Transparent Color Invert, Coarse. Select key color. Mod1 = red, Mod2 = green, Mod3 = blue	31			
	Scan Line. Mod1 selects scan line as texture, Mod2 fades from original image to converted image, Mod3 not used, reserved	32			
	Transparent Wipes. Mod1 = width of transparent area, Mod2 = center of transparent area, Mod3 = transparency mode	33			
	Pixel Twist. Mod1 = x twist center, Mod2 = y twist center, Mod3 = direction and amount of twist	34			
	Picture-in-Picture. Mod1 = x subpicture center, Mod2 = y subpicture center, Mod3 = subpicture size	35			
	Magnifying Lens. Mod1 = x lens center, Mod2 = y lens center, Mod3 = lens size	36			
	Magnifying Lens 2. Mod1 = x lens center, Mod2 = y lens center, Mod3 = lens size	37			
	Cartoon Edge. Mod1 = Edge Color, Mod2 = Contrast, Mod3 = Edge detection sensitivity	38			
	Color DeConverge. Mod1 = Moves red up, Mod2 = Moves green down and right, Mod3 = Moves blue down and left	39			
	Horizontal Mirror. Mod1 = mirror center, Mod2 and Mod3 not used	40	NA	0	0
	RGB Swap to BGR. Mod1 = red, Mod2 = green, Mod3 = blue	41			
	RGB Swap to RBG. Mod1 = red, Mod2 = green, Mod3 = blue	42			
	RGB Swap to GRB. Mod1 = red, Mod2 = green, Mod3 = blue	43			
	Colorize Gray Scale maps pixel intensity to color. Mod1 = Color Scheme selection, Mod2 = Zero intensity point in color scheme, Mod3 = Fading	44			
	Intensity key turns pixels of selected intensity transparent. Mod1 = Color Scheme, Mod2 = Intensity bandwidth, Mod3 = Transparency	45			
	Raindrop effect. Mod1 controls size/speed, Mod2 seeds the random number generator, and Mod3 controls raindrop rate.	46			
	Scale RGB. Mod1 = scale red, Mod2 = scale green, Mod3 = scale blue. Maximum of Mod1, Mod2 and Mod3 sets overall color range	47			
	Tiling on. Mod1 = x-axis tile scale, Mod2 = y-axis tile scaler, Mod3 = space between lines	48			

Parameter	Description	DMX Value		Default	
		Dec.	%	Dec.	%
Graphic Effect Mode 1, 2 & 3	Color to Alpha. Mod1 = red to alpha, Mod2 = green to alpha, Mod3 = blue to alpha	49			
	Color to Alpha, Inverted. Mod1 = cyan to alpha, Mod2 = magenta to alpha, Mod3 = yellow to alpha	50			
	Texture Mixing. Mod1 = Source media file, Mod2 = Source effect level, Mod3 = Crossfade from original to source texture	51			
	Image Scale and Rotate. Mod1 = scales image, Mod2 = rotation angle, Mod3 = rotation speed	52			
	Film Roll. Mod1 = horizontal roll speed, Mod2 = vertical roll speed, Mod3 = Image scale	53			
	Pixelate. Mod1 = Amount of pixelation, Mod2 = horizontal scale, Mod3 = vertical scale	54			
	Faux LED. Mod1 = "LED" size, Mod2 = spacing, Mod 3 = color peaking	55			
	Faux Tile. Mod1 = Tile size, Mod2 = spacing, Mod 3 = color peaking	56			
	Fuzzifier. Mod1 = Horizontal distance, Mod2 = vertical distance, Mod3 = fuzz decay	57			
	Drop Shadow. Mod1 = horizontal shadow size, Mod2 = vertical shadow size, Mod3 = shadow opacity	58	NA	0	0
	Zoom Blur. Mod1 = horizontal position center, Mod2 = vertical position center, Mod3 = zoom	59			
	Chroma Shift. Mod1 = horizontal shift, Mod2 = vertical shift, Mod3 = scale	60			
	ShakeNBake. Mod1 = horizontal shake, Mod2 = vertical shake, Mod3 = scale	61			
	Slats, Vertical. Mod1 = number, Mod2 = displacement, Mod3 = fade	62			
	Slats, Horizontal. Mod1 = number, Mod2 = displacement, Mod3 = fade	63			
	Sinewave, Circular with Y-axis Wobulation Mod1 = size, Mod2 = rate, Mod3 = offset	64			
	Sinewave, Circular with Y-axis Wobulation Mod1 = size, Mod2 = rate, Mod3 = offset	65			
	Sinewave, Circular with Z-axis Wobulation Mod1 = size, Mod2 = rate, Mod3 = offset	66			
	Sinewave, Horizontal with X-axis Wobulation Mod1 = size, Mod2 = rate, Mod3 = offset	67			
	Sinewave, Horizontal with Y-axis Wobulation Mod1 = size, Mod2 = rate, Mod3 = offset	68			

Parameter	Description	DMX Value		Default	
		Dec.	%	Dec.	%
Graphic Effect Mode 1, 2 & 3	Sinewave, Horizontal with Z-axis Wobulation Mod1 = size, Mod2 = rate, Mod3 = offset	69	NA	0	0
	Sinewave, Vertical with X-axis Wobulation Mod1 = size, Mod2 = rate, Mod3 = offset	70			
	Sinewave, Vertical with Y-axis Wobulation Mod1 = size, Mod2 = rate, Mod3 = offset	71			
	Sinewave, Vertical with Z-axis Wobulation Mod1 = size, Mod2 = rate, Mod3 = offset	72			
	Glow: Mod1 = red, Mod2 = green, Mod3 = blue	73			
	Glow Color Cycle: Mod1 = red cycle speed, Mod2 = green cycle speed, Mod3 = blue cycle speed	74			
	Reserved, defaults to Effect 0	75-79			
	Downward Vertical Streaks. Mod1 = start position, Mod2 = streak angle, Mod3 = fade	80			
	Gaussian Blur. Mod1 = sample distance, Mod2 = filter pass number, Mod3 = curve shape	81			
	Sharpen. Mod1 = sample distance, Mod2 = number of filter passes, Mod3 = sharpen scale	82			
	Flip, Mod1 = flip horizontally, Mod2 = flip vertically, Mod3 = not used	83			
	UV to Gray. Mod1 = U coordinate, Mod2 = V coordinate, Mod3 = Tolerance	84			
	UV to Transparent. Mod1 = U coordinate, Mod2 = V coordinate, Mod3 = Tolerance	85			
	UVSelect to Transparent. Mod1 = U coordinate, Mod2 = V coordinate, Mod3 = Tolerance	86			
	HS to Gray. Mod1 = H coordinate, Mod2 = S coordinate, Mod3 = Tolerance	87			
	HS to Transparent. Mod1 = H coordinate, Mod2 = S coordinate, Mod3 = Tolerance	88			
	HSSelect to Transparent. Mod1 = H coordinate, Mod2 = S coordinate, Mod3 = Tolerance	89			
	Texture Shift. Mod1 = horizontal shift, Mod2 = vertical shift, Mod3 = colors and scale	90			
	Lens Grid. Mod1 = magnification, Mod2 = edge shading, Mod3 = number of lenses	91			
	Edge Detect BW2. Mod1 = Sample distance, Mod2 = edge threshold comparison, Mod3 = detected edge scaler	92			
Film Burn. Mod1 = burn/unburn rate, Mod2 = film blackening, Mod3 = burn pattern	93				

Parameter	Description	DMX Value		Default	
		Dec.	%	Dec.	%
Graphic Effect Mode 1, 2 & 3	Film Noise. Mod1 = noise rate, Mod2 = (0,127) push to sepia, (128,255) push to sepia with jitter, Mod3 = noise level	94			
	Particle System 1. Mod1 = emitter type, Mod2 = trail length, Mod3 = particle acceleration	95			
	Particle System 2. Mod1 = number of particles, Mod2 = size of particles, Mod3 = emitter size	96			
	Particle System 3. Mod1 -> particle initial velocity, Mod2 = particle rotation, Mod3 = particle lifetime	97			
	Prism. Mod1 = number of facets, Mod2 = index of refraction, Mod3 = rotation	98			
	Gaussian Halo. Mod1 = sample distance, Mod2 = number of filter passes, Mod3 = shape of Gaussian curve	99			
	Scene Change Detect Mod1 = Scale RGB, Mod2 = RGB to Alpha, Mod3 = Scale color after alpha applied	100	NA	0	0
	Yxy Luminance Scaling. Mod1 = scale luminance (default 64), Mod2 = scale x (default 128), Mod3 = scale	101			
	Prerotation Translation. Mod1 = translate x, Mod2 = translate y, Mod3 = translate z	102			
	Digital Mspeed. Mod1 = rotation mspeed, Mod2 = scaling mspeed, Mod3 = position mspeed	103			
	Reserved. Defaults to effect mode = 0	104-252			
	Special value used with global spherical mapping effect 142. Defaults to 0 otherwise.	253			
	Special value used with global spherical mapping effect 142. Defaults to 0 otherwise.	254			
	Pan and Scan	255			
Graphic Effect Mode Modifier 1	These Modifier parameters adjust the effect selected in the corresponding channel of each of the three Graphic Effect Mode channels.	0-255	0-100		
Graphic Effect Mode Modifier 2	The type of adjustment and the default value depends on the particular effect. NOTE: Setting the Graphic Effect Mode DMX = 253 or 254 activates specific spherical mapping control options for Modifier parameters. For more about Modifier parameter functionality, see <i>Effect Mode Parameters</i> on page 102, and specific effect options listed alphabetically in <i>Chapter 13</i> .	0-255	0-100	NA	NA
Graphic Modifier 3		0-255	0-100		

Parameter	Description	DMX Value		Default	
		Dec.	%	Dec.	%
Graphic Rotation					
X-axis Rotation (vertical flip, 16-bit adjustment)	Continuous variable-speed counterclockwise object rotation around X-axis (fast to slow)	0-16382	0-24	32768	50
	Continuous rotation stop	16383	25		
	Rotates the object counterclockwise around X-axis in steps to -720 degrees absolute	16384-32767	26-49		
	0° rotation around X-axis	32768	50		
	Rotates the object clockwise around X-axis in steps to 720 degrees absolute	32769-49151	51-74		
	Continuous rotation stop	49152	75		
	Continuous variable-speed clockwise object rotation around X-axis (slow to fast)	49154-65535	76-100		
Y-axis Rotation (horizontal flip, 16-bit adjustment)	Continuous variable-speed counterclockwise object rotation around Y-axis (fast to slow)	0-16382	0-24	32768	50
	Continuous rotation stop	16383	25		
	Rotates the object counterclockwise around Y-axis in steps to -720 degrees absolute	16384-32767	26-49		
	0° rotation around Y-axis	32768	50		
	Rotates the object clockwise around Y-axis in steps to 720 degrees absolute	32769-49151	51-74		
	Continuous rotation stop	49152	75		
	Continuous variable-speed clockwise object rotation around Y-axis (slow to fast)	49154-65535	76-100		
Z-axis Rotation (circular 16-bit adjustment)	Continuous variable-speed counterclockwise object rotation around Z axis (fast to slow)	0-16382	0-24	32768	50
	Continuous rotation stop	16383	25		
	Rotates the object counterclockwise around Z-axis in steps to -720 degrees absolute	16384-32767	26-49		
	0° rotation around Z-axis	32768	50		
	Rotates the object clockwise around Z-axis in steps to 720 degrees absolute	32769-49151	51-74		
	Continuous rotation stop	49152	75		
	Continuous variable-speed clockwise object rotation around Z axis (slow to fast)	49154-65535	76-100		

Parameter	Description	DMX Value		Default	
		Dec.	%	Dec.	%
Graphic 1 Scaling					
Scale X	Minimum object size along X axis (1:10)	0	0	32768	50
	Increases object size along X axis from minimum to actual size	1-32767	1-49		
	Actual size along X axis (1:1)	32768	50		
	Increases object size along X axis from actual to maximum size	32769-65534	51-99		
	Maximum object size along X axis (10:1)	65535	100		
Scale Y	Minimum object size along Y axis (1:10)	0	0	32768	50
	Increases object size along Y axis from minimum to actual size	1-32767	1-49		
	Actual size along Y axis (1:1)	32768	50		
	Increases object size along Y axis from actual to maximum size	32769-65534	51-99		
	Maximum object size along Y axis (10:1)	65535	100		
Scale Z	Minimum object size along Z axis (1:10)	0	0	32768	50
	Increases object size along Z axis from minimum to actual size	1-32767	1-49		
	Actual size along Z axis (1:1)	32768	50		
	Increases object size along Z axis from actual to maximum size	32769-65534	51-99		
	Maximum object size along Z axis (10:1)	65535	100		
Graphic 1 Position					
X-Position	Moves object left from center of display	0-36767	0-49	32768	50
	Centers object along X axis in display	32768	50		
	Moves object right from center of display	36769-65535	51-100		
Y-Position	Moves object down from center of display	0-36767	0-49	32768	50
	Centers object along Y axis in display	32768	50		
	Moves object up from center of display	36769-65535	51-100		
Z-Position	Moves object nearer from center of display	0-36767	0-49	32768	50
	Centers object along Z axis in display	32768	50		
	Moves object back along Z axis at center of display	36769-65535	51-100		

Appendix B:

MSpeed Conversion Table

This table lists the MSpeed (motor) movement times and their corresponding DMX controller values.

If you have a numeric-type DMX controller, use the Value Decimal (dec.) column. If you have a fader-type DMX controller, use the Value Percentage (%) column. If your DMX controller allows you to program hex values, use the Value (hex) column.

Time (sec.)	Value (dec.)	Value (%)	Value (hex)	Time (sec.)	Value (dec.)	Value (%)	Value (hex)	Time (sec.)	Value (dec.)	Value (%)	Value (hex)
0.15	255	100	FF	5.34	219	86	DB	20.93	183	72	B7
0.15	254	100	FE	5.64	218	85	DA	21.51	182	71	B6
0.17	253	99	FD	5.94	217	85	D9	22.10	181	71	B5
0.19	252	99	FC	6.25	216	85	D8	22.70	180	71	B4
0.21	251	98	FB	6.56	215	84	D7	23.30	179	70	B3
0.25	250	98	FA	6.89	214	84	D6	23.92	178	70	B2
0.29	249	98	F9	7.22	213	84	D5	24.54	177	69	B1
0.35	248	97	F8	7.56	212	83	D4	25.17	176	69	B0
0.41	247	97	F7	7.91	211	83	D3	25.80	175	69	AF
0.47	246	96	F6	8.27	210	82	D2	26.45	174	68	AE
0.55	245	96	F5	8.63	209	82	D1	27.10	173	68	AD
0.63	244	96	F4	9.00	208	82	D0	27.76	172	67	AC
0.73	243	95	F3	9.39	207	81	CF	28.43	171	67	AB
0.83	242	95	F2	9.77	206	81	CE	29.11	170	67	AA
0.94	241	95	F1	10.17	205	80	CD	29.80	169	66	A9
1.05	240	94	F0	10.58	204	80	CC	30.49	168	66	A8
1.18	239	94	EF	10.99	203	80	CB	31.19	167	65	A7
1.31	238	93	EE	11.41	202	79	CA	31.90	166	65	A6
1.45	237	93	ED	11.84	201	79	C9	32.62	165	65	A5
1.60	236	93	EC	12.28	200	78	C8	33.34	164	64	A4
1.75	235	92	EB	12.72	199	78	C7	34.08	163	64	A3
1.92	234	92	EA	13.17	198	78	C6	34.82	162	64	A2
2.09	233	91	E9	13.63	197	77	C5	35.57	161	63	A1
2.27	232	91	E8	14.10	196	77	C4	36.33	160	63	A0
2.46	231	91	E7	14.58	195	76	C3	37.09	159	62	9F
2.66	230	90	E6	15.07	194	76	C2	37.87	158	62	9E
2.86	229	90	E5	15.56	193	76	C1	38.65	157	62	9D
3.07	228	89	E4	16.06	192	75	C0	39.44	156	61	9C
3.29	227	89	E3	16.57	191	75	BF	39.44v	156	61	9C
3.52	226	89	E2	17.09	190	75	BE	40.23	155	61	9B
3.76	225	88	E1	17.61	189	74	BD	41.04	154	60	9A
4.00	224	88	E0	18.14	188	74	BC	41.85	153	60	99
4.25	223	87	DF	18.68	187	73	BB	42.68	152	60	98
4.52	222	87	DE	19.23	186	73	BA	43.50	151	59	97
4.78	221	87	DD	19.79	185	73	B9	44.34	150	59	96
5.06	220	86	DC	20.36	184	72	B8	45.19	149	58	95

Time (sec.)	Value (dec.)	Value (%)	Value (hex)	Time (sec.)	Value (dec.)	Value (%)	Value (hex)	Time (sec.)	Value (dec.)	Value (%)	Value (hex)
46.04	148	58	94	97.70	99	39	63	171.91	48	19	30
46.90	147	58	93	98.95	98	38	62	173.57	47	18	2F
47.77	146	57	92	100.22	97	38	61	175.24	46	18	2E
48.65	145	57	91	101.49	96	38	60	176.92	45	18	2D
49.54	144	56	90	102.77	95	37	5F	178.61	44	17	2C
50.43	143	56	8F	104.05	94	37	5E	180.30	43	17	2B
51.33	142	56	8E	105.35	93	36	5D	182.01	42	16	2A
52.24	141	55	8D	106.65	92	36	5C	183.72	41	16	29
53.16	140	55	8C	107.96	91	36	5B	185.44	40	16	28
54.09	139	55	8h	109.28	90	35	5A	187.17	39	15	27
55.02	138	54	8A	110.61	89	35	59	188.90	38	15	26
55.96v	137	54	89	111.94	88	35	58	190.65	37	15	25
56.91	136	53	88	113.28	87	34	57	192.40	36	14	24
57.87	135	53	87	114.63	86	34	56	194.16	35	14	23
58.84	134	53	86	115.99	85	33	55	195.92	34	13	22
59.81	133	52	85	117.36	84	33	54	197.70	33	13	21
60.79	132	52	84	118.73	83	33	53	199.48	32	13	20
61.78	131	51	83	120.12	82	32	52	201.28	31	12	1F
62.78	130	51	82	121.5v	81	32	51	203.08	30	12	1E
63.79	129	51	81	122.91	80	31	50	204.88	29	11	1D
64.80	128	50	80	124.31	79	31	4F	206.70	28	11	1C
65.82	127	50	7F	125.73	78	31	4E	208.52	27	11	1B
66.85	126	49	7E	127.15	77	30	4D	210.36	26	10	1A
67.89	125	49	7D	128.58	76	30	4C	212.19	25	10	19
68.94	124	49	7C	130.02	75	29	4B	214.04	24	9	18
69.99	123	48	7B	131.49	74	29	4A	215.90	23	9	17
71.05	122	48	7A	132.97	73	28	49	217.76	22	9	16
72.13	121	47	79	134.46	72	28	48	219.63	21	8	15
73.20	120	47	78	135.96	71	28	47	221.51	20	8	14
74.29	119	47	77	137.47	70	27	46	223.40	19	7	13
75.38	118	46	76	138.99	69	27	45	225.30	18	7	12
76.49	117	46	75	140.52	68	27	44	227.20	17	7	11
77.60	116	45	74	142.06	67	26	43	229.11	16	6	10
78.71	115	45	73	143.61	66	26	42	231.03	15	6	0F
79.84	114	45	72	144.85	65	25	41	232.96	14	5	0E
80.98	113	44	71	146.38	64	25	40	234.90	13	5	0D
82.12	112	44	70	147.92	63	25	3F	236.84	12	5	0C
83.27	111	44	6F	149.46	62	24	3E	238.79	11	4	0B
84.43	110	43	6E	151.01	61	24	3D	240.75	10	4	0A
85.59	109	43	6D	152.57	60	24	3C	242.72	9	4	09
86.77	108	42	6C	154.14	59	23	3B	244.70	8	3	08
87.95	107	42	6B	155.71	58	23	3A	246.68	7	3	07
89.14	106	42	6A	157.30	57	22	39	248.68	6	2	06
90.34	105	41	69	158.89	56	22	38	250.68	5	2	05
91.55	104	41	68	160.49	55	22	37	246.68	7	3	07
92.76	103	40	67	162.09	54	21	36	248.68	6	2	06
93.98	102	40	66	163.71	53	21	35	250.68	5	2	05
95.21	101	40	65	165.33	52	20	34	252.68	4	2	04
96.45	100	39	64	166.96	51	20	33				
				168.60	50	20	32				
				170.25	49	19	31				

Appendix C:

Custom User Content

There are several considerations to keep in mind when creating custom content to control with the DL.2, DL.3 or Axon graphics engine software.

Preparing Custom Content

For the highest quality rendering and playback on a DL.2, DL.3 fixture or Axon media server, use the following steps:

1. Commission or Design High Quality (Visually Clean or Never-Compressed) video, at least 640 x 480 (for DL.2 servers) or 1024 x 768 (for DL.3 servers) in Photo jpeg 98%-100% or Animation Non Compressed (best) format.

NOTE: *Extracting footage from a playable DVD will not give a high quality result since it has been highly compressed.*

2. Light Optimize the content in a video editing program by boosting Brightness and Color Saturation and save the a master file in Photo Jpeg 98%-100% or Animation Non Compressed (best) format.

NOTE: *The DL.3 and Axon media servers can also provide light optimizing as a visual effect, (see Content Optimization on page 82).*

3. Import Video master into Encoder/Compressor.
4. Output encoded files to your hard drive.
5. Upload your Custom Content to the DL.3 fixture or Axon media server, (see *Uploading Content from Your Local Drive to a Media Server* on page 260).

NOTE: *If a file is not compatible, it may load but not appear as output. The CMA thumbnail view of content will note incompatible files with an X.*

Encoder Selection

Any encoder you use will need to provide options that achieve the following specifications:

- Size to 640x480 pixels (for DL.2 servers) or 1024 x 768 (for DL.3 servers)
- All I-frames (an I frame every 1 frame) for optimal tracking
- Constant Bit Rate (CBR) data rates of 10 to 12 megabits/sec
- Closed Group of Picture (GOP)
- Sequence headers each GOP (every frame)
- Progressive frames (since it's a progressive display device, not interlaced)
- End of sequence "Sequence Style"

All the encoders have demos and will batch encode (ExpertHD need a small script and a settings file to batch encode).

Creating 3-D Objects

In general, any 3-D modeling program can be used to create objects. If the particular 3-D modeler does not export in DirectX .x format, a translation program will be needed to translate the object from the modeler's output format to the DirectX .x format. For example, you can use Newtek's Lightwave 3-D® modeler to generate 3-D objects in .lwo format, and then convert the object to .x format using Deep Exploration from Right Hemisphere.

The following list includes some general notes and tips for creating a custom 3-D object.

- With the control parameters (position, scaling and rotation) set at their default values, a rectangle measuring (13.0m, 9.75m, 0m) will just fill the screen.
- Objects are stored in Microsoft's DirectX .x format. .x files may be stored in either text form or binary form.
- An object can have one layer, one surface and one file texture.
- An object's UV (texture) coordinates should be in the range [0.0,1.0] to insure proper presentation. UV coordinates outside this range will wrap to this range but the results are not predictable.
- All polygons should be triangles. When creating objects, it can be easier to work with polygons that have more than three sides. However, an object should only contain triangles (three-sided polygons) when ultimately saved for use with the graphics engine.
- An object can contain multiple, disconnected subobjects as long as item 4 is followed. An example would be an object composed of an array of disconnected spheres or cubes.

NOTE: *For additional assistance and the latest software and techniques for creating and encoding custom content, see the Digital lighting product pages and product support pages at highend.com*

Managing Custom Content

The Content Management Application running on your own computer as a client to DL.3 media servers via Ethernet manages any User Content you create. All Stock and User content can be viewed and refreshed but the CMA client gives you additional control over other aspects of your custom content.

Sections under *Managing User Content* on page 256 in *Chapter 16* describe the User content management functions including instructions on how to:

- Rename files and folders
- Delete files and folders
- Control DMX value assignment to files and folders
- Move files and folders between your local drive and a DL.3 fixture server
- Move files between networked DL.3 fixtures

Appendix D:

DL.2 Specifications

Fixture mechanical, electrical, optical and component specifications are listed.

Mechanical

Fixture Dimensions: 595mm x 598mm x 911mm (23.4in x 23.6in x 35.9in)

Weight: 53.5 kg (118 lbs)

Road Case Dimensions: 699mm x 724mm x 1080mm (27.5in x 28.5in x 42.5in)

Weight (Fixture + Roadcase): 107.5kg (237 lbs)

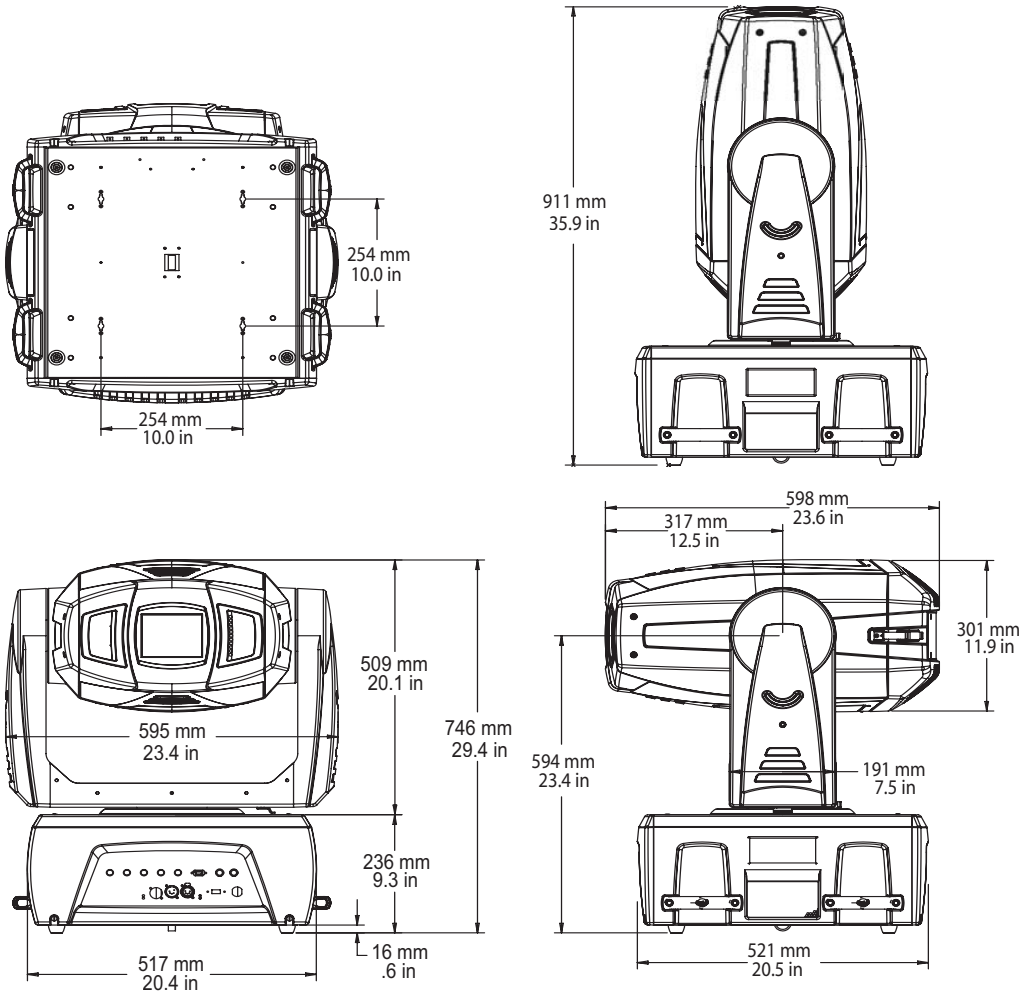

Electrical Specifications

WARNING!

Class 1 equipment – This equipment must be earthed.

Input ratings: 100–120V 7.0A maximum 50/60Hz, 200–240V 3.5A 50/60Hz

Power factor: 0.94

Fuse: Power supply output fuse: 5A, 250V slow blow only.

Lamp: 300W UHP

Light Output: 5500 ANSI lumens (5,000 for models using an LX50 internal projector)

Rated Lamp Life: 1500 hours

Projector Specifications

Model: Christie Digital LX 55

Aspect ratio: 4:3 native

Brightness uniformity: 90%

Contrast ratio: 1000:1, full on/full off

Display technology: 1.3" LCD w/MLA, 3 panels

Panel resolution: 1024 x 768 dots

Zoom Lens Throw Ratio: 1.8 - 2.4:1

Camera Module Specification

Construction: Super HAD CCD sensor technology

Lens: 18x Optical Zoom

Horizontal view angle: 48° –2.8°

Auto focus Range: 29mm – 800mm

Picture Elements: 380K pixels { 768 (H) x 582 (V) }

Minimum working distance: 29mm (WIDE end, 800mm (TELE end)

Environmental Specifications

Maximum ambient temperature (Ta): 35° C (95° F)

Cable and Connector Specifications

Video Connectors:

- RGBHV—BNC x 5
- VGA—DB15
- S-Video—mini-DIN

Peripheral/Network Connectors:

- 2 USB ports

DMX and RS-485 Projector Link

Cables: Belden 9841 or equivalent (meets specifications for EIA RS-485 applications) with the following characteristics:

- Two 4-conductor twisted pairs plus a shield
- Maximum capacitance between conductors: 30 pF/ft
- Maximum capacitance between conductor and shield: 55 pF/ft
- Maximum resistance: 20 Ohm/100 ft
- Nominal impedance: 100–140 Ohm

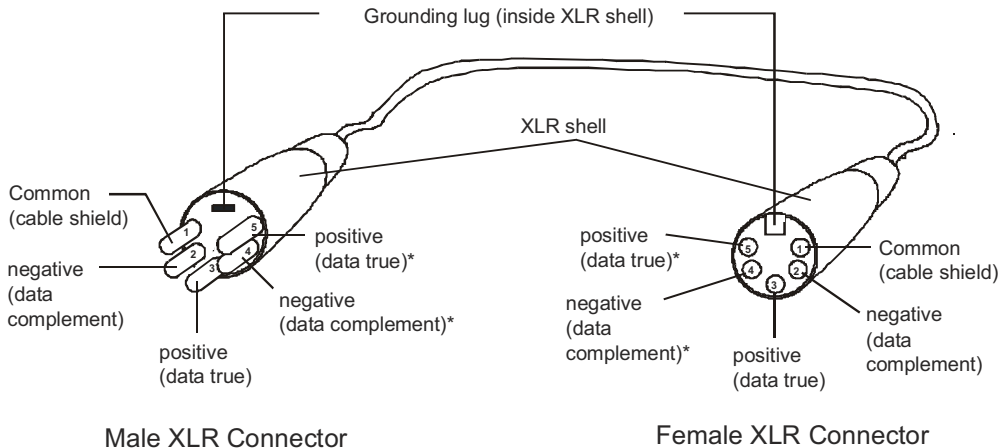

**This data line is not used by the fixture, but allows data to pass through the fixture.*

Connectors: Two 5-pin male and female XLR connectors:

- Pin 1 Ground
- Pin 2 Data–
- Pin 3 Data+
- Pin 4 Secondary data–
- Pin 5 Secondary data+

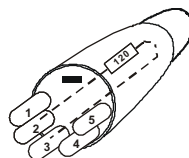

Terminator: 5-pin male XLR connector with a 120 Ohm terminating resistor fitted between pins 2 and 3.

Appendix E:

Safety Information



WARNING! For Continued Protection Against Fire, this equipment is designed for connection to branch circuit with a maximum overload protection of 20 A.



WARNING! For Continued Protection Against Electric Shock

- If this equipment was received without a line cord plug, attach the appropriate line cord plug according to the following code:
 - brown—live
 - blue—neutral
 - green/yellow—earth
- As the colours of the cores in the mains lead of this equipment may not correspond with the coloured markings identifying the terminals in your plug, proceed as follows:
 - the core which is coloured green and yellow must be connected to the terminal in the plug which is marked with the letter E or by the earth symbol , or coloured green or green and yellow.
 - the core which is coloured blue must be connected to the terminal which is marked with the letter N or coloured black.
 - the core which is coloured brown must be connected to the terminal which is marked with the letter L or coloured red.
- Class I equipment. This equipment must be earthed.
- Equipment suitable for dry locations only. Do not expose this equipment to rain or moisture.
- Refer servicing to qualified personnel; no user serviceable parts inside.

Appendice E: Importantes Informations Sur La Sécurité



**Mise En Garde: Pour Une Protection Permanente
Contre Les Incendies: Cet appareil de connection au
circuit comporte une protection contre les surcharges
de 20 A.**



**Mise En Garde: Pour Une Protection Permanente
Contre Les Chocs Électriques**

- Si cet équipement est livré sans prise de cable, veuillez connecter la prise de cable correcte selon le code suivant:
 - marron - phase
 - bleu - neutre
 - vert/jaune - terre
- Débrancher le courant avant de changer les lampes ou d'effectuer des réparations.
- Cet équipement doit être uniquement utilisé dans des endroits secs. Ne pas l'exposer à la pluie ou l'humidité.
- À l'intérieur de l'équipement il n'y a pas de pièces remplaçables par l'utilisateur. Confiez l'entretien à un personnel qualifié.
- Equipement de Classe I. Cet équipement doit être mis à la terre.

Anhang E: Wichtige Hinweise Für Ihre Sicherheit



Warnung: Zum Schutz Vor Brandgefahr: Dieses Gerät darf nur an eine Zweigleitung mit einem Überlastungsschutz von höchstens 20 A angeschlossen werden.



Warnung: Zum Schutz Gegen Gefährliche Körperströme

- Wenn dieses Gerät ohne einen Netzkabelstecker erhalten wurde, ist der entsprechende Netzkabelstecker entsprechend dem folgenden Code anzubringen:
 - Braun - Unter Spannung stehend
 - Blau - Neutral
 - Grün/Gelb - Erde
- Vor dem Austauschen von Lampen oder vor Wartungsarbeiten stets den Netzstecker ziehen.
- Diese Geräte sind nur zum Einbau in trockenen Lagen bestimmt und müssen vor Regen und Feuchtigkeit geschützt werden.
- Servicearbeiten sollten nur von Fachpersonal ausgeführt werden. Das Gerät enthält keine wartungsbedürftigen Teile.
- Dieses Gerät gehört zur Klasse I. Dieses Gerät muß geerdet werden.

Apéndice E: Información Importante De Seguridad



Advertencia: Para Protección Continua Contra Incendios: Este equipo debe conectarse a un circuito que tenga una protección máxima contra una sobrecargas de 20 A.



Advertencia: Para La Protección Continua Contra Electroclusiones

- Si se recibió este equipo sin el conector de alimentación, monte usted el conector correcto según la clave siguiente:
 - moreno - vivo
 - azul - neutral
 - verde/amarillo - tierra
- Desconecte el suministro de energía antes de cambiar lámparas o prestar servicio de reparación.
- Este equipo está diseñado para usarse en lugares secos no lo exponga a la lluvia o humedad.
- Derive el servicio de reparación de este equipo al personal calificado. El interior no contiene repuestos que puedan ser reparados por el usuario.
- Equipo de Clase I. Este equipo debe conectarse a tierra.

Appendice E: Importanti Informazioni Di Sicurezza



Avvertenza: Per Prevenire Incendi: Questa apparecchiatura e' da collegarsi ad un circuito con una protezione da sovraccarico massima di 20 ampere.

Avvertenza: Per Prevenire Le Scosse Elettriche

- Da non montare sopra una superficie infiammabile.
- Mantenere l' apparecchio a un minimo di 1.0 metri (3.28 piedi) di distanza dai materiali combustibili.
- Sostituire i fusibili usando soltanto quelli del tipo e della taratura adatta.
- Mantenere una distanza minima di 1.0 metri (3.28 piedi) dagli oggetti accesi.
- Questa apparecchiatura e' da collegarsi ad un circuito con una protezione da sovraccarico massima di 20 ampere.

Vigtig Sikkerhedsinformation

Advarsel: Beskyttelse mod elektrisk chock.

VIGTIGT! LEDEREN MED GUL/GROEN ISOLATION MAA KUN TILSLUTTES KLEMME MAERKET 

ELLER .

